

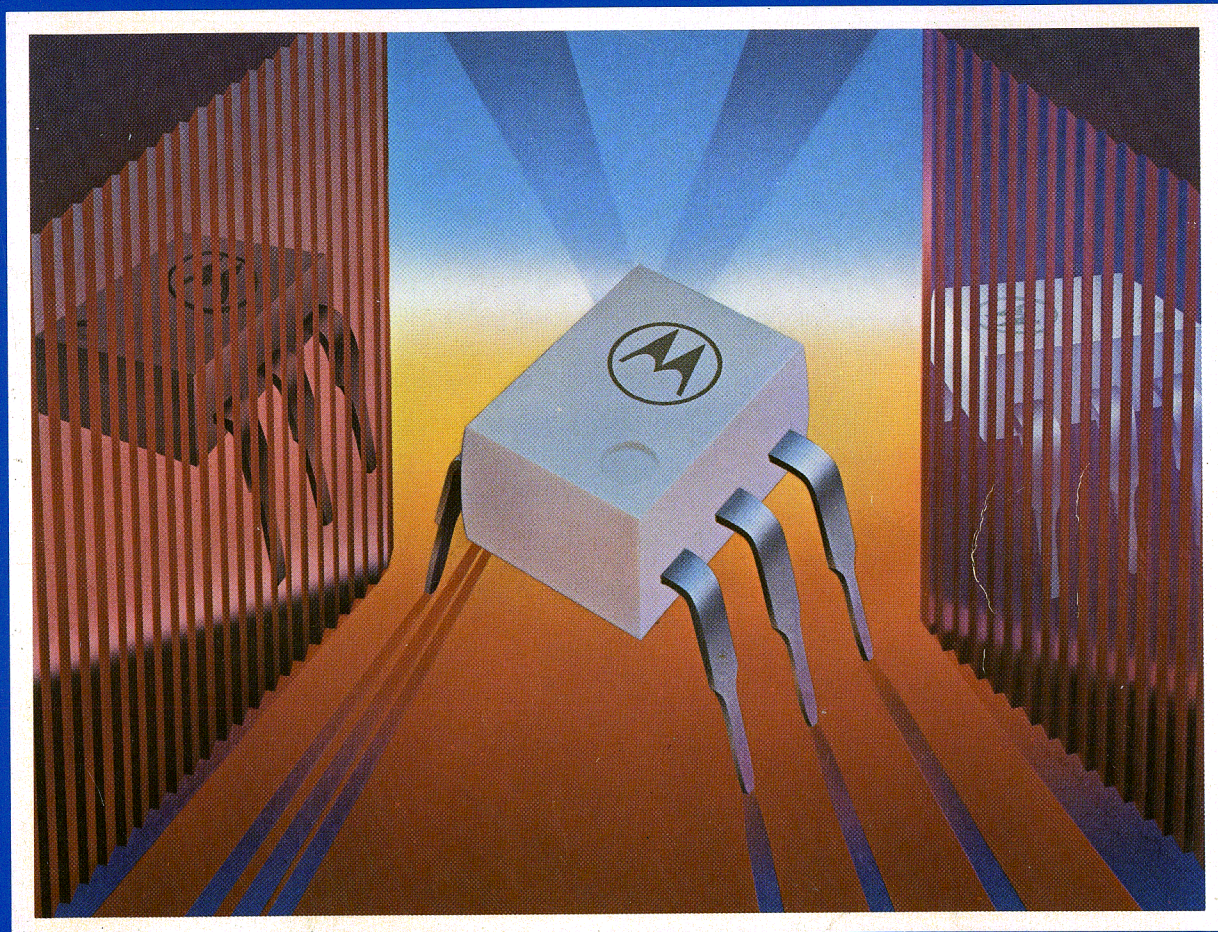

MOTOROLA



OPTOELECTRONICS DEVICE DATA

| | |
|--|----------|
| General Information | 1 |
| Quality and Reliability | 2 |
| Selector Guide and Cross-Reference | 3 |
| Discrete Emitters/Detectors Data Sheets | 4 |
| Fiber Optics Components Data Sheets | 5 |
| Optoisolators/Optocouplers Data Sheets | 6 |
| Slotted Optical Switches Data Sheets | 7 |
| Chips Data Sheets | 8 |
| Applications Information | 9 |



MOTOROLA

**OPTOELECTRONICS
DEVICE DATA**

Prepared by
Technical Information Center

Motorola has concentrated on infrared GaAs and GaAlAs emitters, silicon detectors, high-technology optocoupler/isolators and an innovative approach to Fiber Optic components. This Optoelectronic Data Book contains up-to-date specifications on the complete product line.

The catalog is divided into chapters covering general information, selector guide/cross-reference, reliability and applications for each product segment.

All devices listed are available direct from Motorola and from Motorola's Authorized Distributors. Applications assistance and information on pricing and delivery are available from the nearest Motorola sales office.

Motorola reserves the right to make changes without further notice to any products herein to improve reliability, function or design. Motorola does not assume any liability arising out of the application or use of any product or circuit described herein; neither does it convey any license under its patent rights nor the rights of others. Motorola products are not authorized for use as components in life support devices or systems intended for surgical implant into the body or intended to support or sustain life. Buyer agrees to notify Motorola of any such intended end use whereupon Motorola shall determine availability and suitability of its product or products for the use intended. Motorola and  are registered trademarks of Motorola, Inc. Motorola, Inc. is an Equal Employment Opportunity/Affirmative Action Employer.

Printed in U.S.A.

Fourth Printing
©MOTOROLA INC., 1989
Previous Edition ©1988
"All Rights Reserved"

CONTENTS

| | Page |
|---|------|
| ALPHANUMERIC INDEX | v |
| CHAPTER 1 — GENERAL INFORMATION | 1-1 |
| The Motorola Spectrum of Optoelectronics | 1-2 |
| Emitters | 1-2 |
| Detectors | 1-3 |
| Fiber Optics | 1-3 |
| Optoisolators | 1-3 |
| Opto Assemblies | 1-5 |
| Chips | 1-5 |
| Definitions, Characteristics and Ratings | 1-6 |
| CHAPTER 2 — QUALITY AND RELIABILITY | 2-1 |
| Reliability Considerations | 2-3 |
| Optocoupler Process Flow and QA Inspections (Opto 400 Package) | 2-4 |
| Quality Considerations | 2-5 |
| Opto 400 Evaluation | 2-6 |
| Life and Environmental Test Results | 2-6 |
| Optocoupler Dome Package | 2-9 |
| Optocoupler Process Flow and QA Inspections (Dome Package) | 2-10 |
| CHAPTER 3 — SELECTOR GUIDE AND CROSS-REFERENCE | 3-1 |
| Emitters/Detectors | 3-2 |
| Infrared Emitting Diodes | 3-2 |
| Silicon Photodetectors | 3-2 |
| Optoisolators | 3-3 |
| Optointerrupters | 3-7 |
| Fiber Optic Components | 3-8 |
| Emitters | 3-8 |
| Detectors | 3-8 |
| Opto Chips | 3-10 |
| Die Geometries | 3-10 |
| Opto Chips — Preferred Parts List | 3-10 |
| Cross-Reference | 3-12 |
| CHAPTER 4 — DISCRETE EMITTERS/DETECTORS DATA SHEETS | 4-1 |
| MLED71 Infrared LED | 4-2 |
| MLED76 Visible Red LED | 4-5 |
| MLED77 Infrared LED | 4-8 |
| MLED81 Infrared LED | 4-11 |
| MLED930 Infrared LED | 4-13 |
| MRD150 Photo Detector with Transistor Output | 4-15 |
| MRD300, MRD310 Photo Detectors with Transistor Output | 4-18 |
| MRD360, MRD370 Photo Detectors with Darlington Output | 4-21 |
| MRD500, MRD510 Photo Detectors with Diode Output | 4-24 |

CONTENTS (continued)

Page

CHAPTER 4 — DISCRETE EMITTERS/DETECTORS DATA SHEETS (continued)

| | | |
|---|---|------|
| MRD701 | Photo Detector with Transistor Output | 4-27 |
| MRD711 | Photo Detector with Darlington Output | 4-29 |
| MRD721 | Photo Detector with Pin Diode Output. | 4-31 |
| MRD750 | Photo Detector with Logic Output | 4-34 |
| MRD821 | Photo Detector with Diode Output | 4-38 |
| MRD3010 | Photo Detector with Triac Driver Output | 4-41 |
| MRD3050, MRD3051, MRD3054, MRD3055, MRD3056 | Photo Detectors with Transistor Output. | 4-44 |
| MRD5009 | Photo Detector with Logic Output | 4-47 |

CHAPTER 5 — FIBER OPTICS COMPONENTS DATA SHEETS 5-1

| | | |
|---------------------------------|--|------|
| MFOD71 | FLCS Family — Photo Detector with Diode Output | 5-2 |
| MFOD72 | FLCS Family — Photo Detector with Transistor Output | 5-6 |
| MFOD73 | FLCS Family — Photo Detector with Darlington Output | 5-10 |
| MFOD75 | FLCS Family — Photo Detector with Logic Output | 5-14 |
| MFOD200 | High Performance Family — Photo Detector w/Transistor Output . . | 5-18 |
| MFOD300 | High Performance Family — Photo Detector w/Darlington Output. . | 5-20 |
| MFOD1100 | High Performance Family — Photo Detector w/Diode Output. | 5-22 |
| MFOD2404 | High Performance Family — Photo Detector w/Preamplifier Output | 5-24 |
| MFOD2405 | High Performance Family — Photo Detector w/Preamplifier Output | 5-26 |
| MFOD3100 | MOD Family — Photo Detector with Diode Output | 5-28 |
| MFOD3510 | MOD Family — Photo Detector with Logic Output | 5-30 |
| MFOE71 | FLCS Family — Infrared LED. | 5-34 |
| MFOE76 | FLCS Family — Visible Red LED | 5-36 |
| MFOE200 | High Performance Family — Infrared LED | 5-40 |
| MFOE1100, MFOE1101, MFOE1102 | High Performance Family — Infrared LEDs. | 5-42 |
| MFOE1200 | High Performance Family — Infrared LED | 5-46 |
| MFOE1201, MFOE1202, MFOE1203 | High Performance Family — Infrared LEDs. | 5-48 |
| MFOE3100, MFOE3101, MFOE3102 | MOD Family — Infrared LEDs | 5-52 |
| MFOE3200, MFOE3201, MFOE3202 | MOD Family — Infrared LEDs | 5-56 |

CHAPTER 6 — OPTOISOLATORS DATA SHEETS 6-1

| | | |
|--|--|------|
| 4N25, 4N25A, 4N26, 4N27, 4N28 | 6-Pin DIP Optoisolators with Transistor Output | 6-2 |
| 4N29, 4N29A, 4N30, 4N31, 4N32, 4N32A, 4N33 | 6-Pin DIP Optoisolators with Darlington Output. | 6-6 |
| 4N35, 4N36, 4N37 | 6-Pin DIP Optoisolators with Transistor Output | 6-10 |
| 4N38, 4N38A | 6-Pin DIP Optoisolators with Transistor Output | 6-14 |
| 4N39, 4N40 | 6-Pin DIP Optoisolators with SCR Output. | 6-18 |

CONTENTS (continued)

| | Page |
|--|---|
| CHAPTER 6 — OPTOISOLATORS DATA SHEETS (continued) | |
| CNY17-1, CNY17-2, CNY17-3 | 6-Pin DIP Optoisolators with Transistor Output 6-22 |
| H11A1 thru H11A5 | 6-Pin DIP Optoisolators with Transistor Output 6-26 |
| H11AA1 thru H11AA4 | 6-Pin DIP Optoisolators with AC Input/Transistor Output 6-30 |
| H11AV1,A, H11AV2,A, H11AV3,A | 6-Pin DIP Optoisolators with Transistor Output 6-33 |
| H11B1, H11B2, H11B3 | 6-Pin DIP Optoisolators with Darlington Output 6-37 |
| H11C1, H11C2, H11C3 | 6-Pin DIP Optoisolators with SCR Output 6-41 |
| H11C4, H11C5, H11C6 | 6-Pin DIP Optoisolators with SCR Output 6-44 |
| H11D1, H11D2, H11D3, H11D4 | 6-Pin DIP Optoisolators with Transistor Output 6-48 |
| H11G1, H11G2, H11G3 | 6-Pin DIP Optoisolators with Darlington Output 6-51 |
| H11L1, H11L2 | 6-Pin DIP Optoisolators with Logic Output 6-55 |
| MCT2, MCT2E | 6-Pin DIP Optoisolators with Transistor Output 6-58 |
| MOC119 | 6-Pin DIP Optoisolator with Darlington Output 6-62 |
| MOC205, MOC206, MOC207 | Small Outline Optoisolators with Transistor Output 6-66 |
| MOC211, MOC212, MOC213 | Small Outline Optoisolators with Transistor Output 6-69 |
| MOC215, MOC216, MOC217 | Small Outline Optoisolators with Transistor Output 6-72 |
| MOC221, MOC222, MOC223 | Small Outline Optoisolators with Darlington Output 6-75 |
| MOC1005, MOC1006 | 6-Pin DIP Optoisolators with Transistor Output 6-78 |
| MOC3000, MOC3001 | 6-Pin DIP Optoisolators with SCR Output 6-82 |
| MOC3002, MOC3003, MOC3007 | 6-Pin DIP Optoisolators with SCR Output 6-86 |
| MOC3009, MOC3010, MOC3011, MOC3012 | 6-Pin DIP Optoisolators with Triac Driver Output 6-89 |
| MOC3020, MOC3021, MOC3022, MOC3023 | 6-Pin DIP Optoisolators with Triac Driver Output 6-93 |
| MOC3031, MOC3032, MOC3033 | 6-Pin DIP Optoisolators with Triac Driver Output 6-97 |
| MOC3041, MOC3042, MOC3043 | 6-Pin DIP Optoisolators with Triac Driver Output 6-101 |
| MOC3061, MOC3062, MOC3063 | 6-Pin DIP Optoisolators with Triac Driver Output 6-105 |
| MOC3081, MOC3082, MOC3083 | 6-Pin DIP Optoisolators with Triac Driver Output 6-109 |
| MOC5007, MOC5008, MOC5009 | 6-Pin DIP Optoisolators with Logic Output 6-113 |
| MOC8020, MOC8021 | 6-Pin DIP Optoisolators with Darlington Output 6-116 |
| MOC8030, MOC8050 | 6-Pin DIP Optoisolators with Darlington Output 6-120 |
| MOC8080 | 6-Pin DIP Optoisolator with High Temperature Darlington Output 6-124 |
| MOC8100 | 6-Pin DIP Optoisolator with Transistor Output 6-128 |

CONTENTS (continued)

Page

CHAPTER 6 — OPTOISOLATORS DATA SHEETS (continued)

| | | |
|---------------------------------------|---|-------|
| MOC8101, MOC8102, MOC8103, MOC8104 | 6-Pin DIP Optoisolators for Power Supply Applications | 6-132 |
| MOC8111, MOC8112, MOC8113 | 6-Pin DIP Optoisolators with Transistor Output | 6-135 |
| MOC8204, MOC8205, MOC8206 | 6-Pin DIP Optoisolators with Transistor Output | 6-139 |
| Suffix R, S, T | 6-Pin DIP Optoisolator Lead Form Options | 6-142 |

CHAPTER 7 — SLOTTED OPTICAL SWITCHES DATA SHEETS 7-1

| | | |
|---|---|------|
| H21A1, H21A2, H21A3, H22A1, H22A2, H22A3 | Slotted Optical Switches with Transistor Output | 7-2 |
| H21B1, H21B2, H21B3, H22B1, H22B2, H22B3 | Slotted Optical Switches with Darlington Output | 7-6 |
| MOC70 Series | Slotted Optical Switches with Transistor Output | 7-10 |
| MOC70W1, MOC70W2 | Slotted Optical Switches with Transistor Output | 7-14 |
| MOC71 Series | Slotted Optical Switches with Darlington Output | 7-16 |
| MOC71W1 | Slotted Optical Switches with Darlington Output | 7-20 |
| MOC75T1, MOC75T2, MOC75U1, MOC75U2 | Slotted Optical Switches with Logic Output | 7-22 |

CHAPTER 8 — CHIPS DATA SHEETS 8-1

| | | |
|-----------|--|------|
| MFODC1100 | Photo Detector Chip with Diode Output | 8-2 |
| MFOEC1200 | Infrared LED Chip | 8-4 |
| MLED1000 | Infrared LED Chip | 8-6 |
| MRDC100 | Photo Detector Chip with Diode Output | 8-8 |
| MRDC200 | Photo Detector Chip with Transistor Output | 8-10 |
| MRDC400 | Photo Detector Chip with Darlington Output | 8-12 |
| MRDC600 | Photo Detector Chip with Triac Driver Output | 8-15 |
| MRDC800 | Photo Detector Chip with Triac Driver Output | 8-17 |

CHAPTER 9 — APPLICATIONS INFORMATION 9-1

| | | |
|--------|---|------|
| AN440 | Theory and Characteristics of Phototransistors | 9-3 |
| AN508 | Applications of Phototransistors in Electro-Optic Systems | 9-14 |
| AN571A | Isolation Techniques Using Optical Couplers | 9-28 |
| AN780A | Applications of the MOC3011 Triac Driver | 9-36 |
| AN846 | Basic Concepts of Fiber Optics and Fiber Optic Communications. | 9-42 |
| AN978 | Application of the Motorola VDE Approved Optocouplers | 9-62 |
| AN979 | Guidelines for Circuit Board Assembly of Motorola Case 349 Opto Products | 9-70 |
| AN982 | Applications of Zero Voltage Crossing Optically Isolated Triac Drivers | 9-72 |

Alphanumeric Listing

This listing includes all devices in Motorola's Optoelectronics line.

| Device | Page | Device | Page | Device | Page | Device | Page | Device | Page |
|---------|------|-----------|------|-----------|------|---------|-------|---------|-------|
| 4N25 | 6-2 | H11C6 | 6-44 | MFOE1203 | 5-48 | MOC75T1 | 7-22 | MOC5008 | 6-113 |
| 4N25A | 6-2 | H11D1 | 6-48 | MFOE3100 | 5-52 | MOC75T2 | 7-22 | MOC5009 | 6-113 |
| 4N26 | 6-2 | H11D2 | 6-48 | MFOE3101 | 5-52 | MOC75U1 | 7-22 | MOC8020 | 6-116 |
| 4N27 | 6-2 | H11D3 | 6-48 | MFOE3102 | 5-52 | MOC75U2 | 7-22 | MOC8021 | 6-116 |
| 4N28 | 6-2 | H11D4 | 6-48 | MFOE3200 | 5-56 | MOC119 | 6-62 | MOC8030 | 6-120 |
| 4N29 | 6-6 | H11G1 | 6-51 | MFOE3201 | 5-56 | MOC205 | 6-66 | MOC8050 | 6-120 |
| 4N29A | 6-6 | H11G2 | 6-51 | MFOE3202 | 5-56 | MOC206 | 6-66 | MOC8080 | 6-124 |
| 4N30 | 6-6 | H11G3 | 6-51 | MFOEC1200 | 8-4 | MOC207 | 6-66 | MOC8100 | 6-128 |
| 4N31 | 6-6 | H11L1 | 6-55 | MLED71 | 4-2 | MOC211 | 6-69 | MOC8101 | 6-132 |
| 4N32 | 6-6 | H11L2 | 6-55 | MLED76 | 4-5 | MOC212 | 6-69 | MOC8102 | 6-132 |
| 4N32A | 6-6 | H21A1 | 7-2 | MLED77 | 4-8 | MOC213 | 6-69 | MOC8103 | 6-132 |
| 4N33 | 6-6 | H21A2 | 7-2 | MLED81 | 4-11 | MOC215 | 6-72 | MOC8104 | 6-132 |
| 4N35 | 6-10 | H21A3 | 7-2 | MLED930 | 4-13 | MOC216 | 6-72 | MOC8111 | 6-135 |
| 4N36 | 6-10 | H21B1 | 7-6 | MLED1000 | 8-6 | MOC217 | 6-72 | MOC8112 | 6-135 |
| 4N37 | 6-10 | H21B2 | 7-6 | MOC70H1 | 7-10 | MOC221 | 6-75 | MOC8113 | 6-135 |
| 4N38 | 6-14 | H21B3 | 7-6 | MOC70H2 | 7-10 | MOC222 | 6-75 | MOC8204 | 6-139 |
| 4N38A | 6-14 | H22A1 | 7-2 | MOC70H3 | 7-10 | MOC223 | 6-75 | MOC8205 | 6-139 |
| 4N39 | 6-18 | H22A2 | 7-2 | MOC70K1 | 7-10 | MOC1005 | 6-78 | MOC8206 | 6-139 |
| 4N40 | 6-18 | H22A3 | 7-2 | MOC70K2 | 7-10 | MOC1006 | 6-78 | MRD150 | 4-15 |
| CNY17-1 | 6-22 | H22B1 | 7-6 | MOC70K3 | 7-10 | MOC3000 | 6-82 | MRD300 | 4-18 |
| CNY17-2 | 6-22 | H22B2 | 7-6 | MOC70P1 | 7-10 | MOC3001 | 6-82 | MRD310 | 4-18 |
| CNY17-3 | 6-22 | H22B3 | 7-6 | MOC70P2 | 7-10 | MOC3002 | 6-86 | MRD360 | 4-21 |
| H11A1 | 6-26 | MCT2 | 6-58 | MOC70P3 | 7-10 | MOC3003 | 6-86 | MRD370 | 4-21 |
| H11A2 | 6-26 | MCT2E | 6-58 | MOC70T1 | 7-10 | MOC3007 | 6-86 | MRD500 | 4-24 |
| H11A3 | 6-26 | MFOD71 | 5-2 | MOC70T2 | 7-10 | MOC3009 | 6-89 | MRD510 | 4-24 |
| H11A4 | 6-26 | MFOD72 | 5-6 | MOC70T3 | 7-10 | MOC3010 | 6-89 | MRD701 | 4-27 |
| H11A5 | 6-26 | MFOD73 | 5-10 | MOC70U1 | 7-10 | MOC3011 | 6-89 | MRD711 | 4-29 |
| H11AA1 | 6-30 | MFOD75 | 5-14 | MOC70U2 | 7-10 | MOC3012 | 6-89 | MRD721 | 4-31 |
| H11AA2 | 6-30 | MFOD200 | 5-18 | MOC70U3 | 7-10 | MOC3020 | 6-93 | MRD750 | 4-34 |
| H11AA3 | 6-30 | MFOD300 | 5-20 | MOC70V1 | 7-10 | MOC3021 | 6-93 | MRD821 | 4-38 |
| H11AA4 | 6-30 | MFOD1100 | 5-22 | MOC70V2 | 7-10 | MOC3022 | 6-93 | MRD3010 | 4-41 |
| H11AV1 | 6-33 | MFOD2404 | 5-24 | MOC70V3 | 7-10 | MOC3023 | 6-93 | MRD3050 | 4-44 |
| H11AV1A | 6-33 | MFOD2405 | 5-26 | MOC70W1 | 7-14 | MOC3031 | 6-97 | MRD3051 | 4-44 |
| H11AV2 | 6-33 | MFOD3100 | 5-28 | MOC70W2 | 7-14 | MOC3032 | 6-97 | MRD3054 | 4-44 |
| H11AV2A | 6-33 | MFOD3510 | 5-30 | MOC71H1 | 7-16 | MOC3033 | 6-97 | MRD3055 | 4-44 |
| H11AV3 | 6-33 | MFODC1100 | 8-2 | MOC71H3 | 7-16 | MOC3041 | 6-101 | MRD3056 | 4-44 |
| H11AV3A | 6-33 | MFOE71 | 5-34 | MOC71P1 | 7-16 | MOC3042 | 6-101 | MRD5009 | 4-47 |
| H11B1 | 6-37 | MFOE76 | 5-36 | MOC71P3 | 7-16 | MOC3043 | 6-101 | MRDC100 | 8-8 |
| H11B2 | 6-37 | MFOE200 | 5-40 | MOC71T1 | 7-16 | MOC3061 | 6-105 | MRDC200 | 8-10 |
| | | MFOE1100 | 5-42 | MOC71T3 | 7-16 | MOC3062 | 6-105 | MRDC400 | 8-12 |
| H11C1 | 6-41 | MFOE1101 | 5-42 | MOC71U1 | 7-16 | MOC3063 | 6-105 | MRDC600 | 8-15 |
| H11C2 | 6-41 | MFOE1102 | 5-42 | MOC71U3 | 7-16 | MOC3081 | 6-109 | MRDC800 | 8-17 |
| H11C3 | 6-41 | MFOE1200 | 5-46 | MOC71V1 | 7-16 | MOC3082 | 6-109 | | |
| H11C4 | 6-44 | MFOE1201 | 5-48 | MOC71V3 | 7-16 | MOC3083 | 6-109 | | |
| H11C5 | 6-44 | MFOE1202 | 5-48 | MOC71W1 | 7-20 | MOC5007 | 6-113 | | |

General Information

Motorola Optoelectronic products include gallium arsenide and gallium aluminum arsenide infrared-emitting diodes, silicon photodetectors, optoisolators, slotted optical switches and emitters/detectors for fiber optic communication systems. Emphasis is given to custom assemblies for use in specific automotive, industrial and consumer applications.

Technology leadership in optoelectronic products is demonstrated by state-of-the-art 800 volt, zero-crossing triac drivers (MOC3081); the industry's only standard high temperature Darlington isolator (MOC8080) and the industry's only supplier of standard products with 7500 Vac peak isolation voltage.

The broad optoisolator line includes nearly all the transistor, Darlington, SCR, triac driver and Schmitt trigger devices now available in the industry. Motorola optoisolators come in the standard 6-pin DIP package, and the new small outline SOIC-8 style, surface mount package. Each device is listed in the easy-to-use Selector Guide (Chapter 3) and a detailed data sheet is presented in a succeeding chapter.

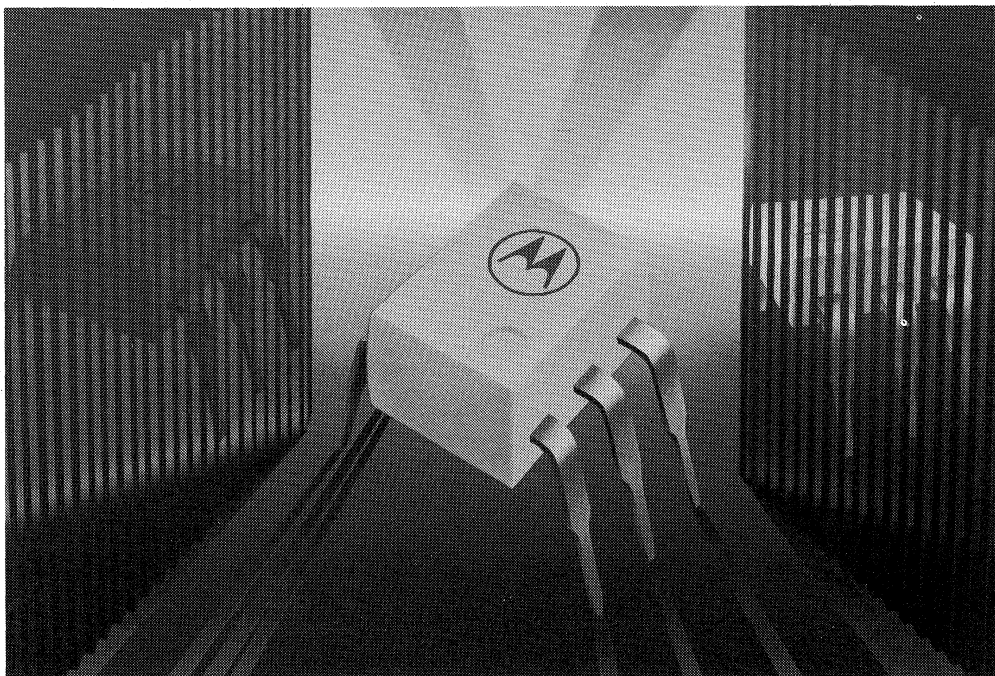

The Motorola Spectrum of OPTOELECTRONICS

Optoelectronics is a special branch of semiconductor technology which has come into prominence during the last fifteen to twenty years. Solid state optoelectronic components have proven to be versatile design tools, offering the engineer inexpensive, reliable alternatives to their bulky predecessors.

Solid state light emitting diodes (LEDs) in the visible portion of the electromagnetic spectrum have virtually eliminated the usage of incandescent lamps as panel indicators. Infrared emitters and silicon photodetectors are finding wider application as sensor pairs, replacing electro-mechanical switches. Optoisolators are being designed into circuits previously using small mechanical relays and pulse transformers.

Over the years, solid state optoelectronic technology has advanced dramatically. Research into new and improved materials and processing techniques have led to devices having higher efficiencies, improved reliability and lower cost.

Emitters

Early emitters, both visible and infrared, suffered from low power output and rapid power output deterioration (degradation) when compared to present day devices. Emitter chip materials, commonly referred to as III-V compounds, are combinations of elements from the III and V columns of the periodic chart. The P-N junction is formed by either diffusing or by epitaxially growing the junction. Typical materials used for emitters include gallium arsenide (GaAs) and gallium aluminum arsenide (GaAlAs), among others.

When a forward bias current (I_F) flows through the emitter's P-N junction, photons are emitted. This is shown schematically in Figure 1. The total output power (P_O) is a function of the forward current (I_F), and is measured in milliwatts. Likewise, the axial radiant intensity (I_O) of an emitting device, which is the portion of the total emitted power radiated within a specified cone angle directly on axis, is also a function of this forward current (I_F), and is measured in milliwatts per steradian.

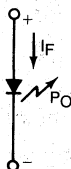

Figure 1. The LED

Motorola's line of emitters operate at wavelengths of either 660, 850 or 940 nanometers (nm). See Figure 2. This encompasses the red and the near infrared portions of the electromagnetic frequency spectrum. Emitters of various wavelengths are produced for the purpose of optimizing system efficiency, when the emitter is operated in conjunction with a variety of applications and environments.

The 940 nm emitters are the most cost effective, however, their spectral emission is not ideally matched to that of the silicon detectors. Most applications can tolerate a certain amount of spectral mismatch, and this sacrifice is generally justified by the devices' lower price. Almost all optoisolators, for example, use the 940 nm emitter.

The 850 nm emitters have a peak emission which almost exactly matches that of silicon. This emitter finds usage in applications where this efficiency, and the emitter's faster speed, are the primary concerns.

The 660 nm emitters are not well matched to silicon, but are ideal for use in plastic fiber optic systems. Plastic fiber has a characteristic attenuation curve which reaches a minimum at 660 nm. This attenuation is the predominant factor to consider when designing a plastic fiber system.

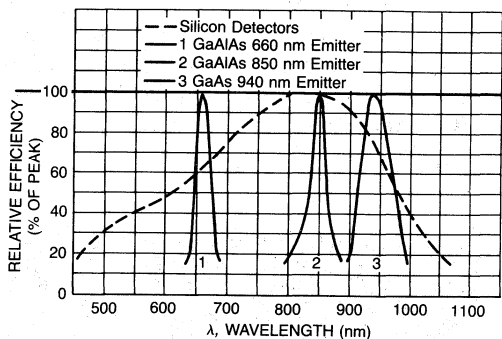

Figure 2. Emissivity versus Wavelength

The above emitters find wide usage in a variety of isolating, sensing, remote control and fiber optic applications.

Newly developed materials and refinements in chip processing and handling have led to more efficient and more reliable emitters. New packaging techniques have made low cost plastic devices suitable for applications formerly requiring glass lensed units, by providing efficient molded-in lenses. In this way, higher on-axis radiant intensities can be achieved, for a given amount of total radiated power. A narrow radiation angle provides for a lower drive current when operating in a configuration where the opto detector is on-axis with the emitter, such as in sensing applications or when launching power into an optical fiber. When a very wide or off-axis viewing angle is required, such as in a remote control situation, emitters with less directional lenses, or unlensed emitters are generally used.

Motorola's selection of emitters includes the low-cost plastic "Case 349" devices, such as MLED71, MLED76 and MLED77. Also in a plastic package is the remote control emitter, MLEDB1.

Metal and glass packages, such as the TO-18 (MLED930) are utilized in applications where high axial intensity or absolute hermeticity are essential.

Advances made in emitter technology over the years have eliminated many of the problems of early-day devices. Even the problem of degradation of emitter power output over time has been brought to a level which is tolerable and predictable. When coupled to a silicon detector, today's devices can be expected to lead a long and useful life.

Detectors

As emitters have developed over the years, photodetectors have also advanced dramatically. Early phototransistors and photodiodes were soon joined by photodarlington detectors, and then by light-activated SCRs. Innovations in design have created devices having higher sensitivity, speed and voltage capabilities. A variety of detectors is shown in Figure 3.

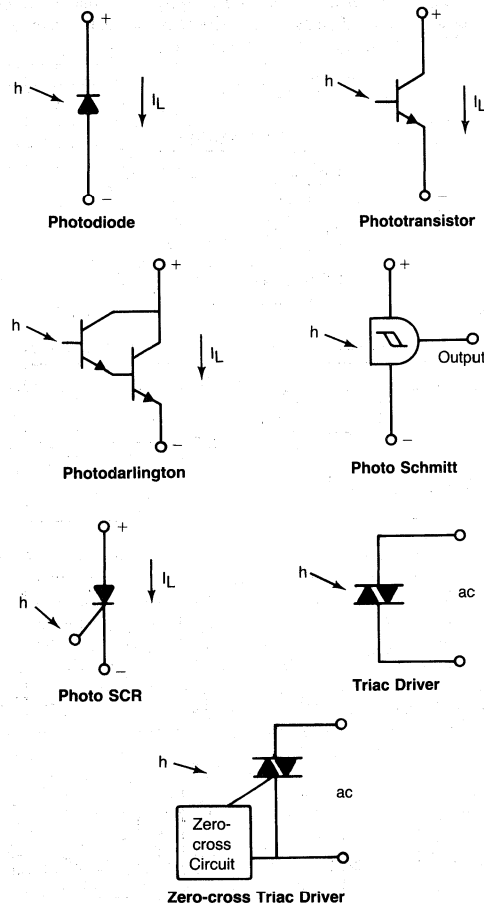

Figure 3. Light Sensitive Detectors

Recent developments in detector technology have led to larger and more complex circuit integration. Photodetectors incorporating Schmitt trigger logic outputs are becoming increasingly popular in applications requiring very fast speed, hysteresis for noise immunity, and logic level outputs.

In 1977, Motorola introduced the world's first photo-triac driver, a planar silicon device capable of controlling loads on an ac power line. This was followed in 1979 by the zero-crossing triac driver, also a Motorola development. This device still stands as a classic example of opto technology's dramatic progress. Bipolar circuitry, photo-optic technology, high voltage solid state physics and field effect transistor (FET) technology are all incorporated on a monolithic integrated circuit chip inside this device.

Future trends point to even higher performance characteristics and more circuit integration in photodetectors.

Detectors, like emitters, are available in plastic and in lensed metal packages.

Fiber Optics

Motorola offers devices specifically designed for either plastic or glass fiber systems. For glass fiber systems, fiber optic emitters and detectors are available in a high performance glass and metal hermetic package, which is compatible with many industry standard fiber optic connectors. A more cost effective choice may be the "MOD" series of emitters and detectors. These devices are packaged with plastic caps instead of metal, and offer moderate performance with moderate price.

For low cost plastic systems, Motorola's popular FLCS (Fiber optic Low Cost System) series is the most economical way to go. Using the MFOE76 emitter distances of up to 180 meters can be achieved, depending on the MFOD detector which is selected. Convenient termination techniques make the FLCS system the first truly practical fiber optic system for general purpose usage.

Optoisolators

Optoisolators, a block diagram of which is shown in Figure 4, are devices which contain at least one emitter, which is optically coupled to a photo-detector through some sort of an insulating medium. This arrangement permits the passage of information from one circuit, which contains the emitter, to the other circuit containing the detector.

Because this information is passed optically across an insulating gap, the transfer is one-way; that is, the detector cannot affect the input circuit. This is important because the emitter may be driven by a low voltage circuit utilizing an MPU or logic gates, while the output photo-detector may be part of a high voltage DC or even an ac load circuit. The optical isolation prevents interaction or even damage to the input circuit to be caused by the relatively hostile output circuit.

The most popular isolator package is the general purpose six-pin DIP, or dual-in-line, package. In this configuration, Pins 1 and 2 are generally connected to the emitter, while Pins 4, 5 and 6 are connected to the detector. Between emitter and detector is an isolating medium which incorporates the

THE MOTOROLA SPECTRUM OF OPTOELECTRONICS (continued)

desired characteristics of high dielectric breakdown, infrared transmissivity, environmental properties, manufacturability and cost.

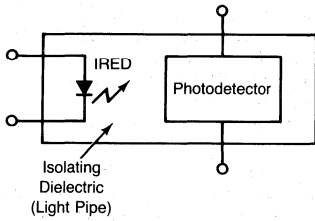

Figure 4. Block Diagram of Optoisolator

Various geometric designs have been used over the years for the internal light cavity between the emitter and detector. These include opposed lead-frame, co-planar, light pipe, and sandwich methods. The first two techniques shown in Figure 5 have been recognized as being superior methods of achieving the high isolation voltage levels which are demanded today. Six-pin DIPs using these isolation techniques are available from Motorola with the industry's highest rating of 7500 volts ac (peak).

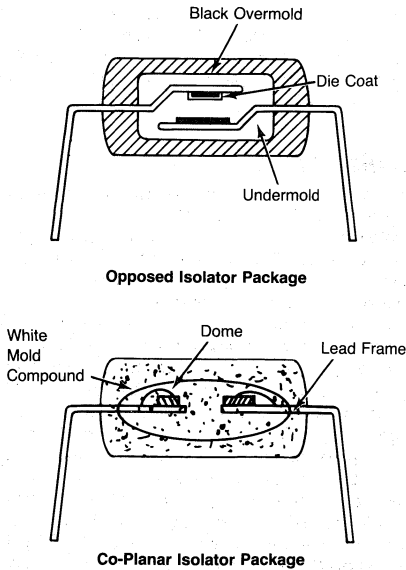

Figure 5. Geometric Designs for Optoisolators

The wide selection of photodetectors mentioned earlier is also available in the isolator packages. A variety of optoisolators is shown in Figure 6. With the emitters and detectors both sealed inside an ambient-protected package, the user need not be concerned with any of the optical considerations necessary with separate packages. An important operating parameter of the isolator is efficiency. This parameter defines the amount of input (emitter) current that is required to obtain a desired detector output. In the case of transistor or darlington output isolators, this efficiency is referred to as "current transfer ratio," or CTR. This is simply the guaranteed output current divided by the required input current. In the case of trigger-type isolators, such as one having Schmitt trigger (logic), SCR or triac driver outputs, efficiency is defined by the amount of emitter current required to trigger the output. This is known as "forward trigger current," or I_{FT} .

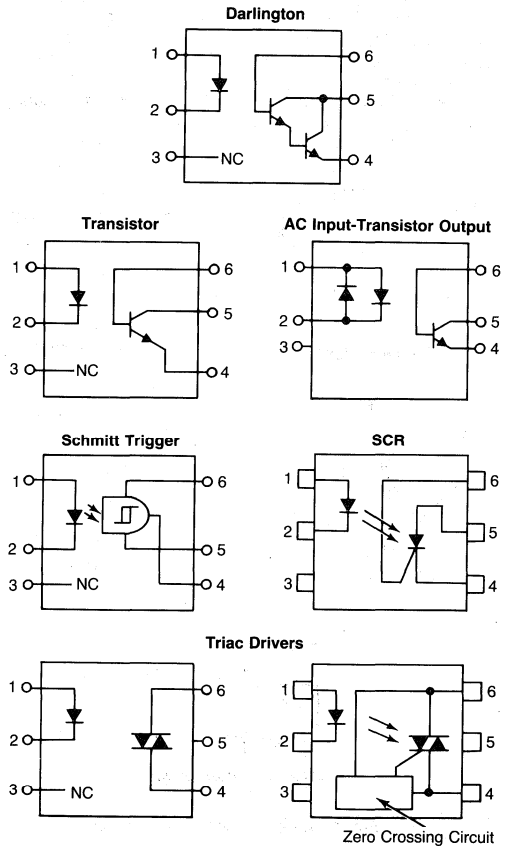

Figure 6. Various Optoisolator Configurations

Efficiency and isolation voltage are two of the most important operating parameters of the optoisolator.

All Motorola six-pin DIP optoisolators are recognized by the Underwriters' Laboratories Component Recognition Program. It should be noted that this recognition extends up to operating voltages of 240 volts ac(rms). Under U.L. criteria, these devices must have passed isolation voltage tests at approximately 5000 volts ac peak for one second. In addition, Motorola tests every six-pin DIP optoisolator to 7500 vac peak for a period of 1 second. Also, Motorola's six-pin DIP optoisolators are offered in a variety of lead form/trim options. These are shown in detail on page 3-13.

Many Motorola optoisolators are approved by VDE, the optoisolator standard which is accepted in most European countries. Check the Motorola data sheet for specific information on approvals to various VDE norms.

Opto Assemblies

Assemblies consist of one or more emitters and detectors in a special purpose package. Common assembly configurations include multiple detector arrays, slotted optical switches and reflective optical sensors. A slotted optical switch is a transmissive device made up of an emitter and a detector inserted into a housing. The housing serves to maintain optical alignment between the emitter and detector and to space them apart from one another to form a sensing area, usually an air gap, between them. These devices perform the same function as optoisolators, with the added feature of mechanical interruptibility. This enables them to detect the presence of an object, or its speed, or in the case of a dual-

channel device, its direction of travel. Slotted optical switches, also known as interrupters, are available in a variety of package styles to accommodate a range of size and mounting restrictions.

Applications for slotted optical switches include paper sensing in printing and copy machines, cursor controls in video game track balls and computer mice, motor speed tachometer sensors, position sensing in computer disk and tape drivers, and as a replacement for mechanical switches in machine control equipment. Angular position can be monitored as well, by means of an optical shaft encoder.

A reflective optical sensor is another type of opto assembly. This incorporates an emitter and a detector in a common housing, and is designed so that the emitted radiation strikes the target object and reflects back to the detector. While the reflective sensor is somewhat trickier to use than the slotted optical switch, it is popular in locations where there is no access to the opposite side of the target object. It is essential that the operating environment around the reflective sensor be free from unwanted stray light sources and reflective surfaces. Applications include end-of-tape sensing, paper sensing and coin-sensing in vending machines.

Motorola has the capability to produce optical assemblies to many custom configurations. You may want to contact your local Motorola sales office for information on this option.

Chips

Many of the Motorola's emitters and detectors are available in chip form. Please refer to chapter 8 of this book for specific chip information.

OPTOELECTRONIC DEFINITIONS, CHARACTERISTICS, AND RATINGS

1

| | | | |
|------------------------|---|--|--|
| CTR | Current Transfer Ratio — The ratio of output current to input current, at a specified bias, of an opto coupler. | | |
| dv/dt | Commutating dv/dt — A measure of the ability of a triac to block a rapidly rising voltage immediately after conduction of the opposite polarity. Coupled dv/dt — A measure of the ability of an opto thyristor coupler to block when the coupler is subjected to rapidly changing isolation voltage. | Triac | A thyristor which can block or conduct in either polarity. Conduction is initiated by forward bias of a gate-MTI junction. |
| E | Luminous Flux Density (Illuminance) [lumens/ft. ² = ft. candles] — The radiation flux density of wavelength within the band of visible light. | T_{stg} V_{(BR)R} | Storage Temperature Reverse Breakdown Voltage — The minimum dc reverse breakdown voltage at stated diode current and ambient temperature. |
| H | Radiation Flux Density (Irradiance) [mW/cm ²] — The total incident radiation energy measured in power per unit area. | V_{(BR)CBO} | Collector-Base Breakdown Voltage — The minimum dc breakdown voltage, collector to base, at stated collector current and ambient temperature. (Emitter open and H ≈ 0) |
| I_{CEO} | Collector Dark Current — The maximum current through the collector terminal of the device measured under dark conditions, (H ≈ 0), with a stated collector voltage, load resistance, and ambient temperature. (Base open) | V_{(BR)CEO} | Collector-Emitter Breakdown Voltage — The minimum dc breakdown voltage, collector to emitter, at stated collector current and ambient temperature. (Base open and H ≈ 0) |
| I_D | Dark Current — The maximum reverse leakage current through the device measured under dark conditions, (H ≈ 0), with a stated reverse voltage, load resistance, and ambient temperature. | V_{(BR)ECO} | Emitter-Collector Breakdown Voltage — The minimum dc breakdown voltage, emitter to collector, at stated emitter current and ambient temperature. (Base open and H ≈ 0) |
| I_{FT} | Input Trigger Current — Emitter current necessary to trigger the coupled thyristor. | V_{CBO} | Collector-Base Voltage — The maximum allowable value of the collector-base voltage which can be applied to the device at the rated temperature. (Base open) |
| I_L | Collector Light Current — The device collector current measured under defined conditions of irradiance, collector voltage, load resistance, and ambient temperature. | V_{CEO} | Collector-Emitter Voltage — The maximum allowable value of collector-emitter voltage which can be applied to the device at the rated temperature. (Base open) |
| R_s | Series Resistance — The maximum dynamic series resistance measured at stated forward current and ambient temperature. | V_{ECO} | Emitter-Collector Voltage — The maximum allowable value of emitter-collector voltage which can be applied to the device at the rated temperature. (Base open) |
| SCR | Silicon Controlled Rectifier — A reverse blocking thyristor which can block or conduct in forward bias, conduction between the anode and cathode being initiated by forward bias of the gate cathode junction. | V_F | Forward Voltage — The maximum forward voltage drop across the diode at stated diode current and ambient temperature. |
| t_f | Photo Current Fall Time — The response time for the photo-induced current to fall from the 90% point to the 10% point after removal of the GaAs (gallium-arsenide) source pulse under stated conditions of collector voltage, load resistance and ambient temperature. | V_{ISO} | Isolation Surge Voltage — The dielectric withstanding voltage capability of an optocoupler under defined conditions and time. |
| t_r | Photo Current Rise Time — The response time for the photo-induced current to rise | V_R | Reverse Voltage — The maximum allowable value of dc reverse voltage which can be applied to the device at the rated temperature. |
| | | λ_s(μm) | Wavelength of maximum sensitivity in micrometers. |

Quality and Reliability

2

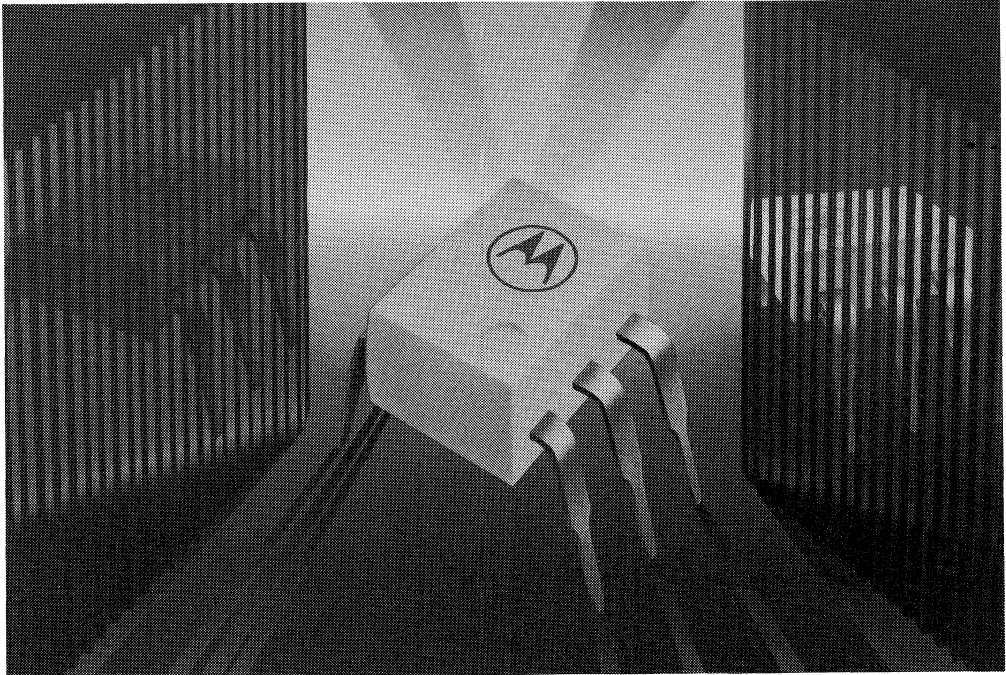

Optocoupler Reliability & Quality

Reliability Considerations

Emitter Life

The area of optocoupler reliability that is of most concern to users is the life of the IRED (Infrared Emitting Diode). Anything which alters the carrier-recombination process (the light-emitting mechanism) will cause a decrease in coupling efficiency with time. There are several possible ways this can happen, depending upon the device and process design:

1. Propagation of initial crystal stress or damage through the device in the vicinity of the junction can cause an increase in non-radiative recombination, since carrier lifetimes are poor in such regions. Motorola now uses exclusively a Liquid Phase Epitaxial (LPE) process which allows a stress-free growth and minimizes the effect of substrate integrity, since the junction is formed some distance from the substrate.
2. Damage caused by assembly of the IRED chip into a package can also cause degradation, usually observable in less than a few hundred hours of operation. Motorola uses automatic die attach and wire attach equipment, so that operator control of pressure is eliminated. In addition, the application of a die passivation during assembly insures that the IRED chip is protected from external mechanical stress.
3. Impurities which exist in the chip as a result of process contamination can be detrimental if they are mobile in gallium arsenide. Forward current bias will energize these impurities and the current drift will draw them toward the junction where they can affect recombination to a greater degree. Proper process design and control of equipment is necessary to minimize this effect. Motorola continually audits its process to provide the necessary monitor on LED life characteristics.
4. Impurities external to the chip can be drawn into the device and affect recombination under certain conditions.

Detector Stability

While the detector has a lesser overall influence on the reliability of an optocoupler than the IRED (due to the difference between gallium-arsenide and silicon characteristics), there still remain important considerations here as well. These primarily are measures of its ability to remain reliably "off" when the IRED is not energized, requiring that breakdown voltages and leakage be stable.

Efficient optically sensitive semiconductors place an extra burden on the manufacturer to produce stable devices. Large surface areas are needed to capture large amounts of light, but also give higher junction leakage.

Low doping concentrations are necessary for long carrier lifetimes, but also create more chance for surface inversion which leads to leakage instability. High electrical gains magnify currents due to captured photons but do the same to junction leakage currents.

Package Integrity

There are several packaging considerations which are unique to an optocoupler. It is necessary, of course, that light be efficiently coupled from input to output. As a result, most optocouplers have internal constructions that are radically different than other semiconductor devices and use materials that are dictated by that construction. Just as parametric stability of the IRED and detector chips used in an optocoupler is important, so also is it important that package parameters be stable. Areas of concern are:

1. **Isolation Voltage** — Together with the transmission of a signal from input to output, the ability of an optocoupler to isolate its input from high voltage at its output is probably its most important feature. Human safety and equipment protection are often critically dependent upon dielectric stability under severe field conditions. Motorola uses a dual molding scheme, whereby an opaque epoxy overmold surrounds an infrared transparent epoxy undermold. Both materials are very stable under repeated applications of high fields and the integrity of the interface between the two materials is assured due to the basic similarity of the compounds. Industry leading isolation voltage capability, both in terms of voltage level and stability, is the result. Motorola specifies all of its optocouplers at 7500 Vac peak isolation.
2. **Mechanical Integrity** — It is also important that the package be capable of withstanding vibration and temperature stresses that may be found in the field environment. Motorola's solid package construction and the use of repeatable automatic ball bond wire attach equipment provide this performance at rated conditions.
3. **Moisture Protection** — Relatively high humidity is characteristic of many field environments, although usually not on a continuous basis. Motorola's chip design minimizes the effect of moisture internal to the package, usually by covering the aluminum metallizations with protective passivations. The package materials typically provide stable isolation voltage after well over 1000 hours of continuous exposure to a high temperature, high humidity environment and will provide very long term service under intermittently humid conditions.

OPTO 400 — A High Reliability Package for Optocouplers

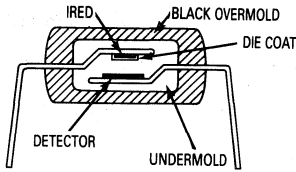

OPTO 400 PERFORMANCE HIGHLIGHTS

- Temperature Cycling over -65°C to $+150^{\circ}\text{C}$
- High Humidity Tolerance — H^3TRB Test
- Low IRED Degradation under Stress — IRED Burn-in Test
- High Isolation Voltage — 7500 Vac peak min.

Various methods of optocoupler packaging and processing can be found throughout the industry. The primary differences are in the internal placement of the emitter and the detector chips and in the type of light transmission medium that is used. The Motorola OPTO 400 package uses two separate lead frame sections, with the Infrared Emitting Diode (IRED) facing the detector chip. An epoxy undermold forms the infrared transmission path, and an opaque epoxy overmold provides strength and immunity to ambient light.

The OPTO 400 optocoupler package is a standard 6-pin DIP package in size and format. It has been subjected to severe and comprehensive environmental testing and demonstrates improved temperature cycling and humidity performance while maintaining the high level of IRED life, isolation voltage, and general environmental stability of the previous 6-pin DIP package.

The package differs from its predecessor in the emitter die coat and undermold materials used. Motorola first developed the undermold-overmold technology to

Optocoupler Process Flow and QA

1 PRE PROBE INSPECTION: A sampled microscopic inspection of class probed wafers for die related defects on the detector and emitter.

2 POST PROBE INSPECTION: Each lot of wafers is sampled and inspected microscopically and electrically to insure quality before shipping to the die cage. This includes both detector and emitter.

3 POST SAW INSPECTION: A sample of die is monitored by microscopic inspection for correct saw cut and checks for cracks, chips, foreign material and missing metal are made. This includes both the detector and emitter.

4 DIE BOND INSPECTION: This microscopic inspection checks both die for die placement and orientation, cracks, chips and die attachment. In addition a random sample of both bonded die are destructively pushed off and the percent of remaining die material evaluated.

5 WIRE BOND INSPECTION: Wire bonds are checked microscopically for placement, bond formation, damaged wire, lifted bonds and missing wire. In addition, a random sample of wires from the emitter and detector die are subjected to a destructive wire pull test.

6 QA INTERNAL VISUAL GATE: This is a sample QA gate to microscopically inspect for all of the defects described in numbers 4 and 5 above. All lots rejected are 100% rescreened.

7 EMITTER DIE COAT INSPECTION: This is a sample inspection to assure the adequacy of the emitter die coating.

8 OVERMOLD INSPECTION: This is a sample microscopic inspection for molding defects and voids.

9 TRIM AND FORM INSPECTION: This is a sample monitor visual inspection of the final trimmed and lead formed units.

10 QA VISO GATE: This is a sample electrical high voltage test of the capabilities of the device and assures the 100% Viso testing performed just prior is without error.

11 QA FINAL VISUAL GATE: This is a final external microscopic inspection for physical defects or damage, plating defects and lead configuration.

12 WEEKLY LED BURN-IN AND TEMPERATURE CYCLE AUDIT: Current Transfer Ratio (CTR) is measured on a sample prior to and after the application of 72 hours of a high forward LED current and the percentage change is calculated. Also a sample of completed units is subjected to 30 cycles of temperature (air-to-air). This information provides trend data which is fed back to direct assembly/processing improvements.

13 QA VISUAL/MECHANICAL AND ELECTRICAL GATE: A random sample from each final test lot is electrically tested to limits. In addition, marking and mechanical defects are gated.

14 OUTGOING FINAL INSPECTION: Outgoing lots are sample inspected for correct packing, part type, part count and documentation requirements.

achieve 7500 Vac peak Isolation Voltage and high CTR. Considerable research and development has been done to improve the thermal and moisture stability of the original undermold compound.

Also included are pre-conditioning screens to eliminate early failures, especially for open or intermittent devices. A 100% temperature cycling is performed prior to electrical testing. Finally, the 100% Group A computer testing includes a high current LED stress test to detect open or intermittent devices.

Quality Considerations

The assembly sequence includes several in-process QA inspections for gating of marginal product and for process control feedback. The acceptance criteria for those inspections are based on a zero-reject philosophy for critical operations.

Inspections (OPTO 400 Package)

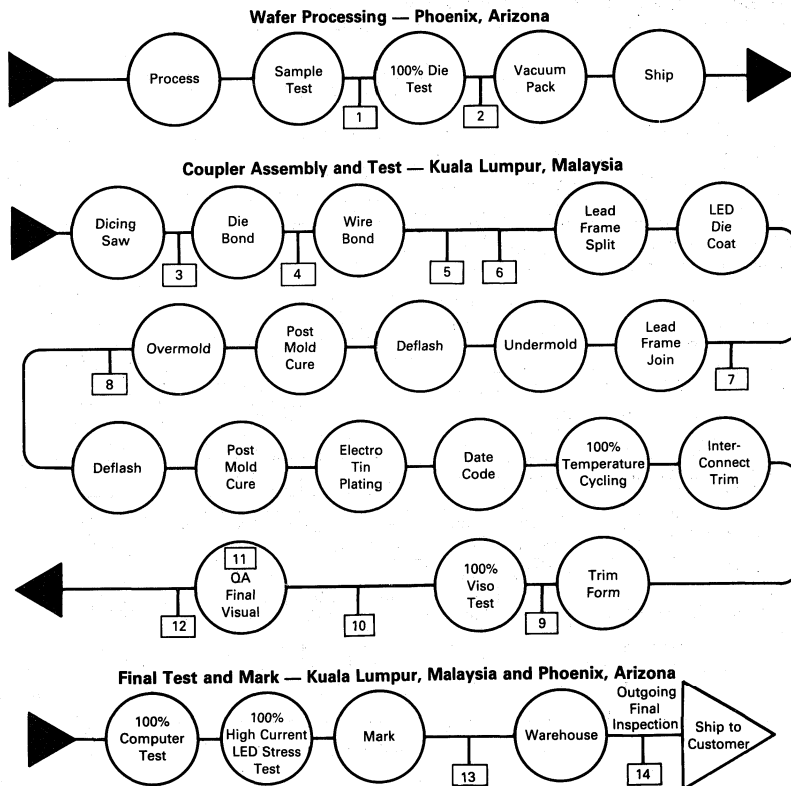

OPTO 400 Evaluation

Package: 6-Pin DIP, Case 730A-02
Die Geometry: GaAs IRED (KSCL93), Silicon Phototransistor Detector (KSC316X, KSC116X)
Device Description: Gallium Arsenide, liquid phase epi, infrared emitting diode optically coupled to a silicon phototransistor detector.
Preconditioning: Parts sampled for the tests covered by this report received only the normal production processing.

Parameters Monitored

| Parameter | Conditions | Limits | | End Point Limits | | Delta |
|------------|--|--------|-------------------|------------------|-------------------|--------------------------------|
| | | Min | Max | Min | Max | |
| I_R | $V_R = 3\text{ V}$ | | 100 μA | | 100 μA | 10 μA , $\pm 100\%$ |
| V_F | $I_F = 10\text{ mA}$ | | 1.5 V | | 1.5 V | 1 V, $\pm 25\%$ |
| V_F | $I_F = 100\text{ mA}$ | | 3 V | | 3 V | 2 V, $\pm 25\%$ |
| I_{CEO} | $V_{CE} = 10\text{ V}$ | | 50 nA | | 50 nA | 10 nA, $\pm 100\%$ |
| I_{CBO} | $V_{CE} = 10\text{ V}$ | | 20 nA | | 20 nA | 10 nA, $\pm 100\%$ |
| h_{FE} | $I_C = 500\ \mu\text{A}$, $V_{CE} = 5\text{ V}$ | 50 | | 50 | | 50, $\pm 25\%$ |
| h_{FE} | $I_C = 1\text{ mA}$, $V_{CE} = 5\text{ V}$ | 50 | | 50 | | 50, $\pm 25\%$ |
| h_{FELC} | $I_F = 10\text{ mA}$, $V_{CE} = 10\text{ V}$ | 2 mA | | 2 mA | | 1 mA, $\pm 25\%$ |
| V_{CE} | $I_F = 50\text{ mA}$, $I_C = 2\text{ mA}$ | | 0.5 V | | 0.5 V | 0.2 V, $\pm 25\%$ |

In this report, any failures are identified by the following criteria:
Catastrophic — Opens or shorts.
Delta — Meet end-point spec limits, but fail established delta criteria.
Limit — Fail end-point spec limits, but devices are still functional.
 Failures and Sample size are indicated by: Number of failures/sample size.

Life and Environmental Test Results

Test results contained herein are for information only. This report does not alter Motorola's standard warranty or product specifications.

IRED Burn-In

The purpose of this test is to demonstrate the performance of power output of the LED versus time under accelerated current conditions. All readouts are normalized to initial values.

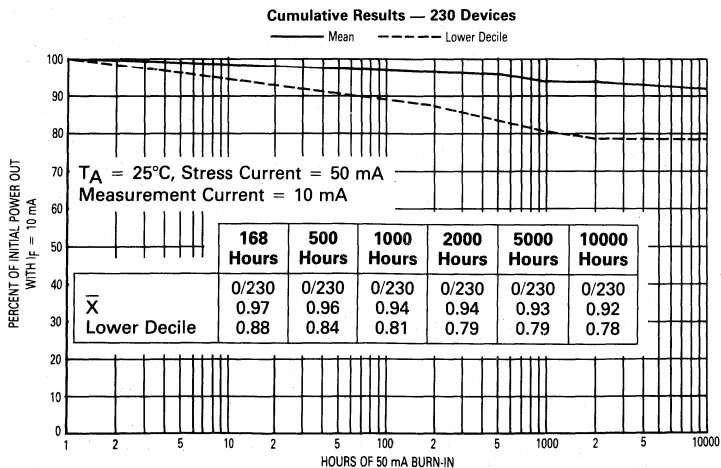

LIFE AND ENVIRONMENTAL TEST RESULTS (continued)

High Temperature Reverse Bias

The purpose of this test is to align mobile contamination via temperature and voltage stresses to form a high current leakage path between two or more terminals. In the case of plastic encapsulated devices, the contamination may be in or on the oxide or in the encapsulant.

| $T_A = 100^\circ\text{C}$, $V_{CB} = 50\text{ Vdc}$ | 168 Hours | 500 Hours | 1000 Hours | 2000 Hours |
|---|--------------|--------------|---------------|---------------|
| Product Line 316X Group I | 0/150 | 0/150 | 0/150 | 0/150 |
| Group II | 0/150 | 0/150 | 0/150 | 0/150 |
| Product Line 116X Group I | 0/500 | 0/500 | 0/500 | 0/500 |
| Group II | 0/50 | 0/50 | 0/50 | 0/50 |

High Temperature Storage

The purpose of this test is to generate time/temperature failure mechanisms and to evaluate long-term storage stability.

| | 168 Hours | 500 Hours | 1000 Hours | 2000 Hours | 5000 Hours |
|--|--------------|--------------|---------------|---------------|---------------|
| $T_A = 100^\circ\text{C}$ Product Line 316X | 0/400 | 0/400 | 0/400 | 0/400 | 0/400 |
| Product Line 116X | 0/600 | 0/600 | 0/600 | 0/600 | 0/600 |

| | 168 Hours | 500 Hours | 1000 Hours | 2000 Hours | 5000 Hours |
|--|--------------|--------------|---------------|---------------|---------------|
| $T_A = 150^\circ\text{C}$ Product Line 116X | 0/50 | 0/50 | 0/50 | 0/50 | 0/50 |

Temperature Cycling

The purpose of this test is to evaluate the ability of the device to withstand both exposure to extreme temperatures and the transition between these temperatures, and to expose thermal mismatch between all materials with the package.

Mil-Std-750, Method 1051, Air-to-Air

| -65°C to +150°C | 100 Cycles | 300 Cycles | 500 Cycles | 1000 Cycles |
|-------------------|---------------|---------------|---------------|----------------|
| Product Line 116X | 1/1200 | 3/1199 | 0/1196 | 0/1196 |

Device failures are catastrophic.

High Temperature High Humidity Reverse Bias

The purpose of this test is to evaluate the moisture resistance of the package. The addition of voltage bias accelerates any corrosive effect after moisture penetration has taken place.

| $T_A = 85^\circ\text{C}$, RH = 85%, $V_{CB} = 50\text{ V}$ | 168 Hours | 500 Hours | 1000 Hours |
|--|--------------|--------------|---------------|
| Product Line 116X | 0/50 | 0/50 | *1/50 |

*One device failed catastrophically.

Thermal Shock

This test is a highly accelerated version of temperature cycling.

Mil-Std-750, Method 1056, (Liquid)

| 0°C to +100°C | 50 Cycles | 100 Cycles | 200 Cycles | 300 Cycles | 400 Cycles | 500 Cycles | 1000 Cycles |
|-------------------|--------------|---------------|---------------|---------------|---------------|---------------|----------------|
| Product Line 316X | 0/200 | 0/200 | 0/200 | 0/200 | 0/200 | 0/200 | 0/200 |
| Product Line 116X | *1/300 | 0/299 | 0/299 | 0/299 | 0/299 | 0/299 | 0/299 |

*Catastrophic Failure.

High Temperature High Humidity

The purpose of this test is to evaluate moisture resistance of the package under accelerated temperature and humidity.

| $T_A = 85^\circ\text{C}$, RH = 85% | 168 Hours | 500 Hours | 1000 Hours | 2000 Hours |
|-------------------------------------|--------------|--------------|---------------|---------------|
| Product Line 316X | 0/200 | *1/200 | 0/199 | 0/199 |
| Product Line 116X | 0/300 | 0/300 | 0/300 | 0/300 |

*One mechanical failure: broken external lead due to handling damage.

Intermittent Operating Life

The purpose of this test is to evaluate the bulk stability of the dice, wire and die bond integrity by means of thermal stressing.

IF = 50 mA, IC = 20 mA, VCE = 10 V,
Turn-on = Turn-off = 1 minute

| $T_A = 25^\circ\text{C}$ | 5000 Cycles | 30,000 Cycles | 60,000 Cycles |
|--------------------------|----------------|------------------|------------------|
| Product Line 316X | 0/200 | 0/200 | 0/200 |
| Product Line 116X | 0/300 | 0/300 | 0/300 |

Moisture Resistance

The purpose of this test is to evaluate the moisture resistance of the component under temperature and humidity conditions typical of a tropical environment.

Mil-Std-750, Method 1021

RH = 90–98%

| | 10 Days | 20 Days | 30 Days | 40 Days | 50 Days |
|-------------------|------------|------------|------------|------------|------------|
| Product Line 316X | 0/120 | 0/120 | 0/120 | 0/120 | 0/120 |
| Product Line 116X | 0/180 | 0/180 | *1/180 | 0/179 | 0/179 |

*One Delta % reject; device still within specification.

2

European Telecommunications Test**

| CNET Ref: | Test Conductions | Results | | |
|-----------|---|----------|--------------|-----------------------|
| | | Rej./SS* | 1000 Hours | |
| | | | Rej./SS* | \bar{X} % Ctr. Deg. |
| E170H | LED Burn-In $T_A = 25^\circ\text{C}$, I_F (stress) = 100 mA, I_F (measure) = 4 mA $T_A = 100^\circ\text{C}$, I_F (stress) = 50 mA, I_F (measure) = 2 mA | | 0/50 0/40 | 95.3 92.5 |
| E1702 | HTS $T_A = 100^\circ\text{C}$ | | 0/250 | |
| E1703 | HTVISO $T_A = 70^\circ\text{C}$, ≥ 500 Vdc on LED | 0/100 | | |
| E1704 | HTVISO (LED Burn-In) $T_A = 100^\circ\text{C}$, $I_F = 50$ mA, ≥ 500 Vdc on LED | | 0/40 | 92.5 |
| C-1501 | H ³ T $T_A = 40^\circ\text{C}$, RH = 93% | | 0/1000 | |
| C-1506B | Intermittence $T_A = 25^\circ\text{C}$ to $+125^\circ\text{C}$, 3 min @ ext. 5 cycles | 0/1000 | | |
| E1701-2-A | HTRB $T_A = 100^\circ\text{C}$, $V_{CE} = 20$ V | | 0/50 | |

**Results of tests performed at Motorola to CNET STC968-3521.

*SS — Sample Size

IRE D Burn-In To Typical European Telecommunications Requirements

| Test Temperature | | Stress Current | Results | | |
|------------------|--|----------------|-------------------------------|--------------|--------------|
| Temp (°C) | | IF (mA) | Initial | 168 Hours | 1000 Hours |
| 25 | | 10 | Rej./SS 0/47 X % Ctr. Deg. | 0/47 0.98 | 0/47 0.96 |
| 25 | | 50 | Rej./SS 0/50 X % Ctr. Deg. | 0/50 1.01 | 0/50 0.97 |
| 25 | | 100 | Rej./SS 0/40 X % Ctr. Deg. | 0/40 0.96 | 0/40 0.92 |
| 50 | | 10 | Rej./SS 0/43 X % Ctr. Deg. | 0/43 0.98 | 0/43 0.95 |
| 50 | | 50 | Rej./SS 0/48 X % Ctr. Deg. | 0/48 0.94 | 0/48 0.93 |
| 50 | | 100 | Rej./SS 0/25 X % Ctr. Deg. | 0/25 0.92 | 0/25 0.90 |
| 100 | | 10 | Rej./SS 0/45 X % Ctr. Deg. | 0/45 1.01 | 0/45 1.06 |
| 100 | | 50 | Rej./SS 0/40 X % Ctr. Deg. | 0/40 0.94 | 0/40 0.93 |
| 100 | | 100 | Rej./SS 0/50 X % Ctr. Deg. | 0/50 0.90 | 0/50 0.85 |

All readouts are normalized to initial values.
Note: All readout measurements were made at $I_F = 10$ mA.

European Safety Tests*

| Group I | |
|--|----------|
| A. Functional Test | |
| B. Temp Cycle — -40°C to $+150^\circ\text{C}$, 5 cycles | |
| C. HTS — $T_A = +70^\circ\text{C}$, -500 Vdc on detector, 16 hours | |
| D. H ³ T — $T_A = 40^\circ\text{C}$, RH = 90%, 12 hours | |
| E. H ³ T — $T_A = 25^\circ\text{C}$, RH = 95%, 12 hours | |
| F. Storage — $T_A = -40^\circ\text{C}$, 12 hours | |
| G. H ³ T — $T_A = 40^\circ\text{C}$, RH = 90%, 12 hours | 5 cycles |
| H. H ³ T — $T_A = 25^\circ\text{C}$, RH = 95%, 12 hours | |
| I. HTS — $T_A = 55^\circ\text{C}$, 6 hours | |
| J. Functional Test (Including V_{ISO} @ 100°C) | |
| Results | 0/150 |

| Group II | |
|--|------|
| A. Functional Test | |
| B. H ³ T — $T_A = 40^\circ\text{C}$, RH = 95%, 21 days | |
| C. HTS — $T_A = 55^\circ\text{C}$, 6 hours | |
| D. Vibration — 55-2kHz, 10 G's, 90 minutes | |
| E. Functional Test 8 (Including V_{ISO} @ 100°C) | |
| Results | 0/75 |

*Results of tests performed at Motorola to VDE0883.

Optocoupler Dome Package

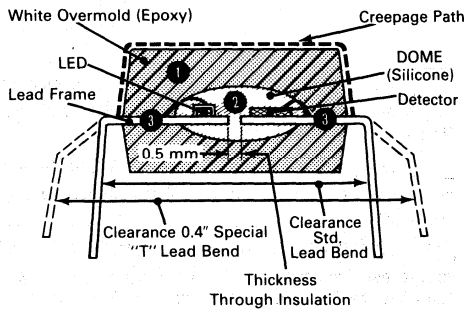

The DOME package is a manufacturing/quality improvement in that it represents a significant reduction in the complexity of the assembly steps. This is consistent with Motorola's goal of continual quality improvement by reduction in process variations (in this case through assembly simplification).

The following reliability testing summary confirms the quality of design and material selection.

2

Dome Package Evaluation

Package: 6-Pin DIP, Case 730A-02 (WHITE)

Dice: Same as used in present Opposed Package

Parameters Monitored

| Parameter | Conditions | Limits | | | |
|---------------|---|---------|-------------------|------------|-------------------|
| | | Initial | | End Points | |
| | | Min | Max | Min | Max |
| I_R | $V_R = 3\text{ V}$ | | 100 μA | | 100 μA |
| V_F | $I_F = 10\text{ mA}$ | | 1.5 V | | 1.5 V |
| I_{CEO} | $V_{CE} = 10\text{ V}$ | | 50 nA | | 50 nA |
| I_{CBO} | $V_{CB} = 10\text{ V}$ | | 20 nA | | 20 nA |
| $V_{(BR)CEO}$ | $I_C = 1\text{ mA}$ | 30 V | | 30 V | |
| $V_{(BR)CBO}$ | $I_C = 100\ \mu\text{A}$ | 70 V | | 70 V | |
| $V_{(BR)ECO}$ | $I_E = 100\ \mu\text{A}$ | 7 V | | 7 V | |
| I_C/I_F | $V_{CE} = 120\text{ V}$ | 2 mA | | 2 mA | |
| $V_{CE(sat)}$ | $I_F = 10\text{ mA}$ $I_C = 2\text{ mA}$ $I_F = 50\text{ mA}$ | | 0.5 V | | 0.5 V |
| V_{ISO} | $f = 60\text{ Hz } t = 1\text{ Sec.}$ | 5.35 k | | — | |

Life and Environmental Testing Results

| Test | Conditions | Sample Size | Rejects | |
|-----------------------------|---|-------------|---------|--------------|
| | | | Limit | Catastrophic |
| IRED Burn-In | $I_F = 50\text{ mA } t = 1000\text{ Hrs.}$ | 100 | 0 | 0 |
| H ³ TRB | $T_A = 85^\circ\text{C } RH = 85\%$ | 71 | 0 | 0 |
| HTRB | $V_{CB} = 50\text{ V, } t = 1000\text{ Hrs.}$ $T_A = 100^\circ\text{C } V_{CB} = 50\text{ V}$ $t = 1000\text{ Hrs.}$ | 80 | 0 | 0 |
| Intermittent Operating Life | $I_F = 50\text{ mA } I_C = 10\text{ mA}$ $V_{CE} = 10\text{ V } T_{on} = T_{off} = 1\text{ Min}$ $t = 1000\text{ Hrs.}$ | 100 | 0 | 0 |
| High Temperature Storage | $T_A = 125^\circ\text{C } t = 1000\text{ Hrs.}$ | 99 | 0 | 0 |
| Temperature Cycle | $-40^\circ\text{C to } +125^\circ\text{C}$ Air-To-Air 15 Min at Extremes 1200 Cycles | 58 | 0 | 0 |
| Thermal Shock | Liquid-To-Liquid $0^\circ\text{C to } +100^\circ\text{C}$ 500 Cycles | 100 | 0 | 0 |
| Resistance to Solder Heat | MIL-Std-750, Method 2031 260°C for 10 sec Followed by V_{ISO} | 50 | 0 | 0 |
| Lead Pull | MIL-Std-750, Method 2036 Cond A, 2 Lbs. 1 Min | 5 | 0 | 0 |

Optocoupler Process Flow and

2

1 PRE PROBE INSPECTION: A sampled microscopic inspection of class probed wafers for die related defects on the detector and emitter.

2 POST PROBE INSPECTION: Each lot of wafers is sampled and inspected microscopically and electrically to insure quality before shipping to the die cage. This includes both detector and emitter.

3 POST SAW INSPECTION: A sample of die is monitored by microscopic inspection for correct saw cut, and checks for cracks, chips, foreign material and missing metal are made. This includes both the detector and emitter.

4 DIE BOND INSPECTION: This microscopic inspection checks both die for die placement and orientation, cracks, chips and die attachment. In addition, a random sample of both bonded die are pushed off and the percent of remaining material evaluated.

5 WIRE BOND INSPECTION: Wire bonds are checked microscopically for placement, bond formation, damaged wire, lifted bonds and missing wire. In addition, a random sample of wire from the emitter and detector are subjected to a destructive wire pull test.

6 QA INTERNAL VISUAL GATE: This is a sampled QA gate to microscopically inspect for all of the defects described in numbers 4 and 5 above. All lots rejected are 100% re-screened before resubmitting.

7 QA VISUAL GATE: This is a sampled gate for the quality and dimensions of the dome coating operation.

8 MOLD INSPECTION: This is monitor inspection of a sample of molded units for defects such as voids, incomplete fills etc.

9 LEAD TRIM AND FORM INSPECTION: The final trimmed and formed units are monitored through a visual inspection.

10 QA VISO GATE: This is a sampled electrical high voltage test of the capabilities of the device and assures the 100% Viso testing performed just prior is without error.

11 QA FINAL VISUAL INSPECTION: This is a final external microscopic inspection for physical defects or damage, plating defects and lead configuration.

12 WEEKLY LED BURN-IN AND TEMPERATURE CYCLING AUDIT: Current transfer ratio (CTR) is measured on a sample prior to and after the application of 72 hours of a high forward LED stress current and the percentage change is calculated. Also a sample of completed units is subjected to 300 cycles of air to air temperature cycling. This information provides trend data which is fed back to direct assembly/processing improvements.

13 QA VISUAL/MECHANICAL AND ELECTRICAL GATE: A random sample from each final test lot is electrically tested to documented limits. In addition, marking and mechanical defects are gated.

14 OUTGOING FINAL INSPECTION: Outgoing lots are sample inspected for correct packing, part type, part count and documentation requirements.

QA Inspections (Dome Package)

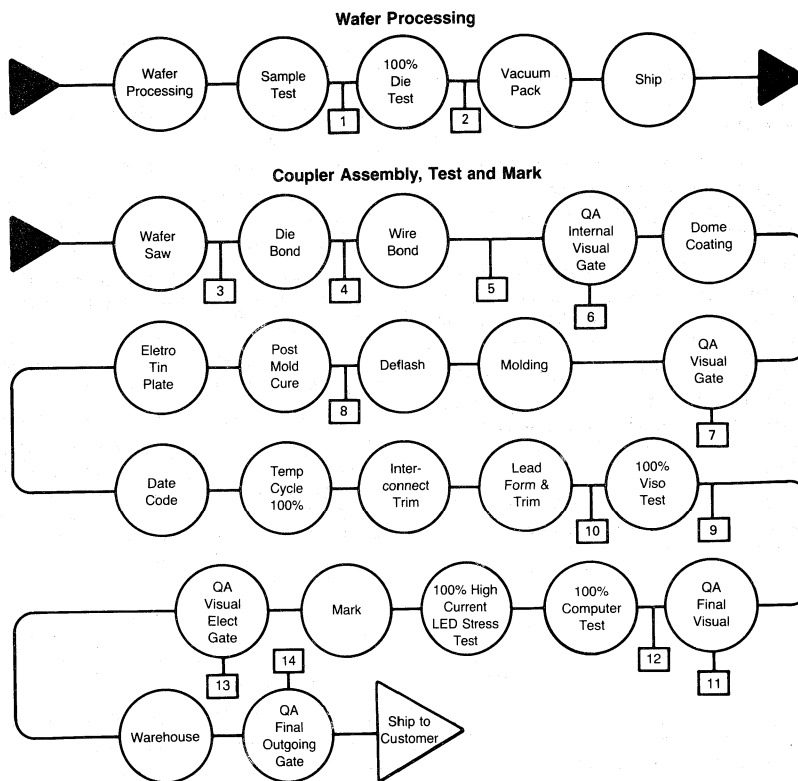

2

Selector Guide and Cross-Reference

3

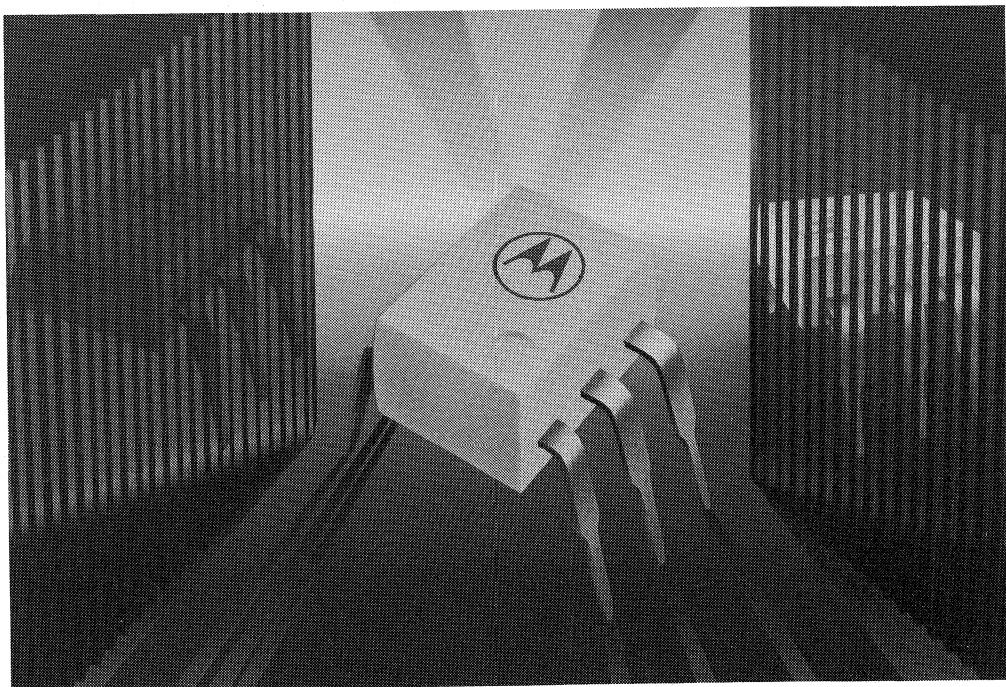

Emitters/Detectors

Infrared Emitting Diodes

Motorola's infrared emitting diodes are made by the liquid phase epitaxial process for long life and stability. They provide high power output and quick response at 660 nm, 850 nm or 940 nm with low input drive current.

| Device | Power Output μW @ I_F Typ mA | Emission Angle Typ | Peak Emission Wavelength nm Typ | Forward Voltage @ I_F Max mA | Case/Style |
|---------|---|-----------------------|------------------------------------|--------------------------------------|---------------|
| MLED71 | 2500 | 50 | 60° | 1.8 | 50 349-03/1 |
| MLED76 | 4000 | 100 | 60° | 2.2 | 60 349-03/4 |
| MLED77 | 2500 | 100 | 60° | 2 | 100 349-03/4 |
| MLED81 | 16000 | 100 | 60° | 1.7 | 100 279B-01/1 |
| MLED930 | 650 | 100 | 30° | 1.5 | 50 209-01/1 |

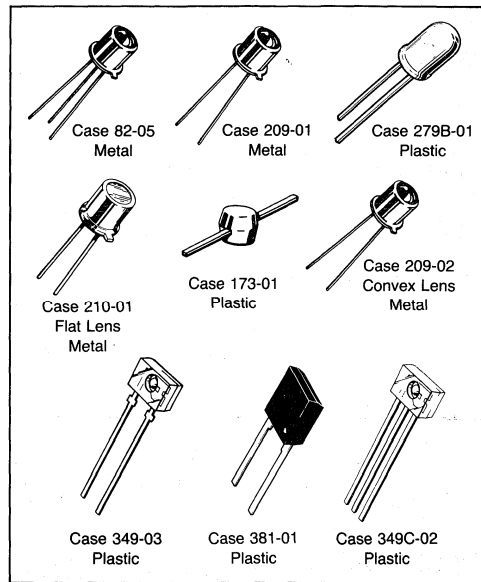

Silicon Photodetectors

A variety of silicon photodetectors are available, varying from simple PIN diodes to complex, single chip 400 volt triac drivers. They offer choices of viewing angle and size in either economical plastic cases or rugged, hermetic metal cans. They are spectrally matched for use with Motorola infrared emitting diodes.

PIN Photodiodes — Response Time = 1 ns Typ

| Device | Light Current @ $V_R = 20\text{ V}$, $H = 5\text{ mW/cm}^2$ μA | Dark Current @ $V_R = 20\text{ V}$ nA (Max) | Case/Style |
|--------|---|---|------------|
| MRD500 | 9 | 2 | 209-02/1 |
| MRD510 | 2 | 2 | 210-01/1 |
| MRD721 | 4 | 10 | 349-03/1 |
| MRD821 | 250 | 60 | 381-01/1 |

Phototransistors

| Device | Light Current @ $V_{CC} = 20$, $H = 5\text{ mW/cm}^2$ mA (Typ) | $V_{(BR)CEO}$ Volts (Min) | t_r/t_f @ $V_{CC} = 20$, $I_L = 1000\ \mu\text{A}$ μs (Typ) | Case/Style |
|---|--|------------------------------|--|------------|
| MRD150 | 2.2 | 40 | 2.5/4 | 173-01/1 |
| MRD310 | 3.5 | 50 | 2/2.5 | 82-05/1 |
| MRD300 | 8 | 50 | 2/2.5 | |
| MRD3050 | 0.1 Min | 30 | 2/2.5 | |
| MRD3051 | 0.2 Min | 30 | 2/2.5 | |
| MRD3054 | 0.5 Min | 30 | 2/2.5 | |
| MRD3055 | 1.5 Min | 30 | 2/2.5 | |
| MRD3056 | 2 Min | 30 | 2/2.5 | |
| t_{on}/t_{off} @ $V_{CC} = 5\text{ V}$ | | | | |
| MRD701 | 0.5 | 30 | 10/60 | 349-03/2 |

Photodarlington

| Device | Light Current @ $V_{CC} = 5$, $H = 0.5\text{ mW/cm}^2$ mA (Typ) | $V_{(BR)CEO}$ Volts (Min) | t_r/t_f @ $V_{CC} = 5\text{ V}$ μs (Typ) | Case/Style |
|--------|---|------------------------------|---|------------|
| MRD370 | 10 | 40 | 15/40 | 82-05/1 |
| MRD360 | 20 | 40 | 15/65 | |
| MRD711 | 25 | 60 | 125/150 | 349-03/2 |

Photothyristors — Triac Drivers

| Device | I_{FT} mW/cm ² Max | $I_{T(RMS)}$ mA Max | V_{DRM} Volts Peak Min | I_{DRM} nA Typ | Case/Style |
|---------|---------------------------------------|---------------------------|--------------------------------|------------------------|------------|
| MRD3010 | 5 | 100 | 250 | 10 | 82-05/3 |

Photo Schmitt Trigger

| Device | Threshold Current mA | | $I_{F(off)}$ $I_{F(on)}$ Typ | V_{CC} Volts | t_r/t_f μs Typ | Case/Style |
|---------|-------------------------|------------|------------------------------------|-------------------|--------------------------------|------------|
| | ON Max | OFF Min | | | | |
| MRD750 | 20 | 1.0 | 0.75 | 3-15 | 0.1 | 349C-02/3 |
| MRD5009 | 20 | 1.0 | 0.75 | 3-15 | 0.1 | 82-05/1 |

Optoisolators

6-Pin DIP

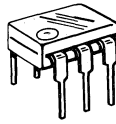

Case 730A-02

An optoisolator consists of a gallium arsenide infrared emitting diode, IRED, optically coupled to a monolithic silicon photo-detector in a light-shielding package. Motorola offers a wide array of standard devices and encourages the use of special designs and selections for special appli-

cations. All 6-pin DIP Motorola optoisolators are UL Recognized per File Number 54915 and VDE approved per Certificate Number 41853; all have V_{ISO} rating of 7500 Vac(pk), exceeding all other industry standard ratings.

Transistor Output (Style 1)

Pinout: 1-Anode, 2-Cathode, 3-N.C., 4-Emitter, 5-Collector, 6-Base

| Device | Current Transfer Ratio (CTR) | | | VCE(sat) | | | t_r/t_f or t_{on}^*/t_{off}^* Typ | | | | V(BR)CEO Volts Min | VF | |
|----------|------------------------------|---------------------|-----------|-----------|---------------------|-------------------|---------------------------------------|---------------------|-----------|------------------|--------------------|-------------------|-----------|
| | % Min | @ I _F mA | VCE Volts | Volts Max | @ I _F mA | I _C mA | μs | @ I _C mA | VCC Volts | R _L Ω | | I _F mA | Volts Max |
| TIL112 | 2 | 10 | 5 | 0.5 | 50 | 2 | 2/2 | 2 | 10 | 100 | 20 | 1.5 | 10 |
| TIL111 | 8 | 16 | 0.4 | 0.4 | 16 | 2 | 5/5 | 2 | 10 | 100 | 30 | 1.4 | 16 |
| 4N27 | 10 | 10 | 10 | 0.5 | 50 | 2 | 1.2/1.3 | 10 | 10 | 100 | 30 | 1.5 | 10 |
| 4N28 | 10 | 10 | 10 | 0.5 | 50 | 2 | 1.2/1.3 | 10 | 10 | 100 | 30 | 1.5 | 10 |
| 4N38,A | 10 | 10 | 10 | 1 | 20 | 4 | 1.6/2.2 | 10 | 10 | 100 | 80 | 1.5 | 10 |
| H11A4 | 10 | 10 | 10 | 0.4 | 10 | 0.5 | 1.2/1.3 | 2 | 10 | 100 | 30 | 1.5 | 10 |
| 4N25,A | 20 | 10 | 10 | 0.5 | 50 | 2 | 1.2/1.3 | 10 | 10 | 100 | 30 | 1.5 | 10 |
| 4N26 | 20 | 10 | 10 | 0.5 | 50 | 2 | 1.2/1.3 | 10 | 10 | 100 | 30 | 1.5 | 10 |
| H11A2 | 20 | 10 | 10 | 0.4 | 10 | 0.5 | 1.2/1.3 | 2 | 10 | 100 | 30 | 1.5 | 10 |
| H11A3 | 20 | 10 | 10 | 0.4 | 10 | 0.5 | 1.2/1.3 | 2 | 10 | 100 | 30 | 1.5 | 10 |
| H11A520 | 20 | 10 | 10 | 0.4 | 20 | 2 | 5*/5* | 2 | 10 | 100 | 30 | 1.5 | 10 |
| H11AV3,A | 20 | 10 | 10 | 0.4 | 20 | 2 | 5*/4* | 2 | 10 | 100 | 70 | 1.5 | 10 |
| MCT2 | 20 | 10 | 10 | 0.4 | 16 | 2 | 1.2/1.3 | 5 | 2k | 15 | 30 | 1.5 | 20 |
| MCT2E | 20 | 10 | 10 | 0.4 | 16 | 2 | 1.2/1.3 | 2 | 10 | 100 | 30 | 1.5 | 20 |
| TIL116 | 20 | 10 | 10 | 0.4 | 15 | 2.2 | 5/5 | 2 | 10 | 100 | 30 | 1.5 | 60 |
| H11A5 | 30 | 10 | 10 | 0.4 | 10 | 0.5 | 1.2/1.3 | 2 | 10 | 100 | 30 | 1.7 | 10 |
| CNY17-1 | 40-80 | 10 | 5 | 0.4 | 10 | 2.5 | 1.6/2.3 | 5 | 75 | 10 | 70 | 1.65 | 60 |
| MCT271 | 45-90 | 10 | 10 | 0.4 | 16 | 2 | 4.9*/4.5* | 2 | 5 | 100 | 30 | 1.5 | 20 |
| MOC8100 | 50 | 1 | 5 | 0.5 | 1 | 0.1 | 3.8/5.6 | 2 | 10 | 100 | 30 | 1.4 | 1 |
| H11A1 | 50 | 10 | 10 | 0.4 | 10 | 0.5 | 1.2/1.3 | 2 | 10 | 100 | 30 | 1.5 | 10 |
| H11A550 | 50 | 10 | 10 | 0.4 | 20 | 2 | 5*/5* | 2 | 10 | 100 | 30 | 1.5 | 10 |
| H11AV2,A | 50 | 10 | 10 | 0.4 | 20 | 2 | 5*/4* | 2 | 10 | 100 | 70 | 1.5 | 10 |
| TIL117 | 50 | 10 | 10 | 0.4 | 10 | 0.5 | 5/5 | 2 | 10 | 100 | 30 | 1.4 | 16 |
| TIL126 | 50 | 10 | 10 | 0.4 | 10 | 1 | 2/2 | 2 | 10 | 100 | 30 | 1.4 | 10 |
| CNY17-2 | 63-125 | 10 | 5 | 0.4 | 10 | 2.5 | 1.6/2.3 | 5 | 75 | 10 | 70 | 1.65 | 60 |
| MCT275 | 70-210 | 10 | 10 | 0.4 | 16 | 2 | 4.5*/3.5* | 2 | 5 | 100 | 80 | 1.5 | 20 |
| MCT272 | 75-150 | 10 | 10 | 0.4 | 16 | 2 | 6*/5.5* | 2 | 5 | 100 | 30 | 1.5 | 20 |
| 4N35 | 100 | 10 | 10 | 0.3 | 10 | 0.5 | 3.2/4.7 | 2 | 10 | 100 | 30 | 1.5 | 10 |
| 4N36 | 100 | 10 | 10 | 0.3 | 10 | 0.5 | 3.2/4.7 | 2 | 10 | 100 | 30 | 1.5 | 10 |
| 4N37 | 100 | 10 | 10 | 0.3 | 10 | 0.5 | 3.2/4.7 | 2 | 10 | 100 | 30 | 1.5 | 10 |
| H11A5100 | 100 | 10 | 10 | 0.4 | 20 | 2 | 5*/5* | 2 | 10 | 100 | 30 | 1.5 | 10 |
| CNY17-3 | 100-200 | 10 | 5 | 0.4 | 10 | 2.5 | 1.6/2.3 | 5 | 75 | 10 | 70 | 1.65 | 60 |
| H11AV1,A | 100-300 | 10 | 10 | 0.4 | 20 | 2 | 5*/4* | 2 | 10 | 100 | 70 | 1.5 | 10 |
| MCT273 | 125-250 | 10 | 10 | 0.4 | 16 | 2 | 7.6*/6.6* | 2 | 5 | 100 | 30 | 1.5 | 20 |
| MCT274 | 225-400 | 10 | 10 | 0.4 | 16 | 2 | 9.1*/7.9* | 2 | 5 | 100 | 30 | 1.5 | 20 |

(R) = RMS (D) = DC *_{on}, *_{off}

Transistor Output with No Base Connection (Style 3)

Pinout: 1-Anode, 2-Cathode, 3-N.C., 4-Emitter, 5-Collector, 6-N.C.

| Device | Current Transfer Ratio (CTR) | | | VCE(sat) | | | t_r/t_f or t_{on}^*/t_{off}^* Typ | | | | V(BR)CEO Volts Min | VF | |
|---------|------------------------------|---------------------|-----------|-----------|---------------------|-------------------|---------------------------------------|---------------------|-----------|------------------|--------------------|-------------------|-----------|
| | % Min | @ I _F mA | VCE Volts | Volts Max | @ I _F mA | I _C mA | μs | @ I _C mA | VCC Volts | R _L Ω | | I _F mA | Volts Max |
| MOC8101 | 50 | 10 | 10 | 0.4 | 5 | 0.5 | 3.2/4.7 | 2 | 10 | 100 | 30 | 1.5 | 10 |
| MOC8102 | 73 | 10 | 10 | 0.4 | 5 | 0.5 | 3.2/4.7 | 2 | 10 | 100 | 30 | 1.5 | 10 |
| MOC8103 | 108 | 10 | 10 | 0.4 | 5 | 0.5 | 3.2/4.7 | 2 | 10 | 100 | 30 | 1.5 | 10 |
| MOC8104 | 160 | 10 | 10 | 0.4 | 5 | 0.5 | 3.2/4.7 | 2 | 10 | 100 | 30 | 1.5 | 10 |
| MOC8111 | 20 | 10 | 10 | 0.4 | 10 | 0.5 | 3.2/4.7 | 2 | 10 | 100 | 30 | 1.5 | 10 |
| MOC8112 | 50 | 10 | 10 | 0.4 | 10 | 0.5 | 3.2/4.7 | 2 | 10 | 100 | 30 | 1.5 | 10 |
| MOC8113 | 100 | 10 | 10 | 0.4 | 10 | 0.5 | 3.2/4.7 | 2 | 10 | 100 | 30 | 1.5 | 10 |

AC Input — Transistor Output (Style 8)

Pinout: 1-LED 1 Anode/LED 2 Cathode, 2-LED 1 Cathode/LED 2 Anode, 3-N.C., 4-Emitter, 5-Collector, 6-Base

| Device | I _F mA | V _{CE} Volts | I _C mA | V _{CE(sat)} Volts | V _F Volts | V(BR)CEO Volts | VF Volts |
|--------|-------------------|-----------------------|-------------------|----------------------------|----------------------|----------------|----------|
| H11AA1 | 20 | ±10 | 10 | 0.4 | ±10 | 0.5 | 30 |
| H11AA2 | 10 | ±10 | 10 | 0.4 | ±10 | 0.5 | 30 |
| H11AA3 | 50 | ±10 | 10 | 0.4 | ±10 | 0.5 | 30 |
| H11AA4 | 100 | ±10 | 10 | 0.4 | ±10 | 0.5 | 30 |

3

6-Pin DIP Optoisolators (continued)

Case 730A-02

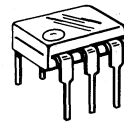

Darlington Output (Style 1)

Pinout: 1-Anode, 2-Cathode, 3-N.C., 4-Emitter, 5-Collector, 6-Base

| | | | | | | | | | | | | | | |
|---------|-----|----|------|-----|----|-----|-----------|-----|----|-----|-----|----|-----|----|
| 4N31 | 50 | 10 | 10 | 1.2 | 8 | 2 | 0.6*/17* | 50 | 10 | | 200 | 30 | 1.5 | 10 |
| 4N29,A | 100 | 10 | 10 | 1 | 8 | 2 | 0.6*/17* | 50 | 10 | | 200 | 30 | 1.5 | 10 |
| 4N30 | 100 | 10 | 10 | 1 | 8 | 2 | 0.6*/17* | 50 | 10 | | 200 | 30 | 1.5 | 10 |
| H11B255 | 100 | 10 | 5 | 1 | 50 | 50 | 125*/100* | 10 | 10 | 100 | | 55 | 1.5 | 20 |
| MCA230 | 100 | 10 | 5 | 1 | 50 | 50 | 10/35 | | 10 | 100 | 50 | 30 | 1.5 | 20 |
| MCA255 | 100 | 10 | 5 | 1 | 50 | 50 | 10/35 | | 10 | 100 | 50 | 55 | 1.5 | 20 |
| H11B2 | 200 | 1 | 5 | 1 | 1 | 1 | 1/2 | | 10 | 100 | | 25 | 1.5 | 10 |
| MCA231 | 200 | 1 | 1 | 1.2 | 10 | 50 | 80 | | 10 | 100 | | 30 | 1.5 | 20 |
| TIL113 | 300 | 10 | 1.25 | 1 | 50 | 125 | 300 | 125 | 15 | 100 | | 30 | 1.5 | 10 |
| 4N32,A | 500 | 10 | 10 | 1 | 8 | 2 | 0.6*/45* | | 50 | 10 | 200 | 30 | 1.5 | 10 |
| 4N33 | 500 | 10 | 10 | 1 | 8 | 2 | 0.6*/45* | | 50 | 10 | 200 | 30 | 1.5 | 10 |
| H11B1 | 500 | 1 | 5 | 1 | 1 | 1 | 1/2 | | 10 | 100 | | 25 | 1.5 | 10 |
| MOC8080 | 500 | 10 | 5 | 1 | 1 | 1 | 1/2 | | 10 | 100 | 5 | 55 | 1.5 | 10 |

Darlington Output with No Base Connection (Style 3)

Pinout: 1-Anode, 2-Cathode, 3-N.C., 4-Emitter, 5-Collector, 6-N.C.

| | | | | | | | | | | | | | | |
|---------|------|----|-----|---|----|----|-----|-----|----|-----|---|----|-----|----|
| MOC119 | 300 | 10 | 2 | 1 | 10 | 10 | 1/2 | 2.5 | 10 | 100 | | 30 | 1.5 | 10 |
| TIL119 | 300 | 10 | 2 | 1 | 10 | 10 | 300 | 2.5 | 10 | 100 | | 30 | 1.5 | 10 |
| MOC8030 | 300 | 10 | 1.5 | | | | 1/2 | | 10 | 100 | 5 | 80 | 2 | 10 |
| MOC8020 | 500 | 10 | 5 | | | | 1/2 | | 10 | 100 | 5 | 50 | 2 | 10 |
| MOC8050 | 500 | 10 | 1.5 | | | | 1/2 | | 10 | 100 | 5 | 80 | 2 | 10 |
| MOC8021 | 1000 | 10 | 5 | | | | 1/2 | | 10 | 100 | 5 | 50 | 2 | 10 |

Resistor-Darlington Output (Style 1)

Pinout: 1-Anode, 2-Cathode, 3-N.C., 4-Emitter, 5-Collector, 6-Base

| | | | | | | | | | | | | | | |
|-------|------|----|---|-----|----|----|---------|--|---|-----|----|-----|-----|----|
| H11G1 | 1000 | 10 | 1 | 1 | 1 | 1 | 5*/100* | | 5 | 100 | 10 | 100 | 1.5 | 10 |
| H11G2 | 1000 | 10 | 1 | 1 | 1 | 1 | 5*/100* | | 5 | 100 | 10 | 80 | 1.5 | 10 |
| H11G3 | 200 | 1 | 5 | 1.2 | 50 | 20 | 5*/100* | | 5 | 100 | 10 | 55 | 1.5 | 10 |

High Voltage Transistor Output (Style 1)

Pinout: 1-Anode, 2-Cathode, 3-N.C., 4-Emitter, 5-Collector, 6-Base

| | | | | | | | | | | | | | | |
|---------|--------|----|----|-----|----|-----|-----------|----|----|-----|--|-----|-----|----|
| MOC8204 | 20 | 10 | 10 | 0.4 | 10 | 0.5 | 5*/5* | 2 | 10 | 100 | | 400 | 1.5 | 10 |
| H11D1 | 20 | 10 | 10 | 0.4 | 10 | 0.5 | 5*/5* | 2 | 10 | 100 | | 300 | 1.5 | 10 |
| H11D2 | 20 | 10 | 10 | 0.4 | 10 | 0.5 | 5*/5* | 2 | 10 | 100 | | 300 | 1.5 | 10 |
| H11D3 | 20 | 10 | 10 | 0.4 | 10 | 0.5 | 5*/5* | 2 | 10 | 100 | | 200 | 1.5 | 10 |
| H11D4 | 10 | 10 | 10 | 0.4 | 10 | 0.5 | 5*/5* | 2 | 10 | 100 | | 200 | 1.5 | 10 |
| 4N38 | 10 | 10 | 10 | 1 | 20 | 4 | 1.6/2.2 | 10 | 10 | 100 | | 80 | 1.5 | 10 |
| 4N38A | 10 | 10 | 10 | 1 | 20 | 4 | 1.6/2.2 | 10 | 10 | 100 | | 80 | 1.5 | 10 |
| MCT275 | 70-210 | 10 | 10 | 0.4 | 16 | 2 | 4.5*/3.5* | 2 | 5 | 100 | | 80 | 1.5 | 20 |

(R) = RMS (D) = DC *_{on} /_{off}

SCR Output (Style 7)

| Device | Peak Blocking Voltage Min | LED Trigger Current-I _{FT} (V _{AK} = 50 V) mA Max | V _{ISO} Vac Pk | dv/dt V/μs Typ |
|---------|---------------------------|---|-------------------------|----------------|
| 4N39 | 200 | 30 | 1500 | 500 |
| 4N40 | 400 | 30 | 1500 | 500 |
| H11C1 | 200 | 20 | 3535 | 500 Min |
| H11C2 | 200 | 20 | 2500 | 500 Min |
| H11C3 | 200 | 30 | 2500 | 500 Min |
| MCS2400 | 400 | 14(V _{AK} = 100 V) | 3000 RMS | |
| MOC3000 | 400 | 20 | 7500 | 500 |
| MOC3001 | 400 | 30 | 7500 | 500 |
| MOC3002 | 250 | 30 | 7500 | 500 |
| MOC3003 | 250 | 20 | 7500 | 500 |
| MOC3007 | 200 | 40 | 7500 | 500 |
| H11C4 | 400 | 20 | 3535 | 500 |
| H11C5 | 400 | 20 | 2500 | 500 |
| H11C6 | 400 | 30 | 2500 | 500 |

6-Pin DIP Optoisolators (continued)

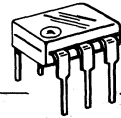

Triac Driver Output (Style 6)

Case 730A-02

Pinout: 1-Anode, 2-Cathode, 3-N.C., 4-Main Terminal, 5-Substrate, 6-Main Terminal

| Device | Peak Blocking Voltage Min | LED Trigger Current- I_{FT} ($V_{TM} = 3V$) mA Max | Zero Crossing Inhibit Voltage (at rated I_{FT}) Volts Max | VISO Vac Pk | dv/dt V/ μ s Typ |
|---------|---------------------------|--|--|-------------|----------------------|
| MOC3009 | 250 | 30 | — | 7500 | 10 |
| MOC3010 | 250 | 15 | — | 7500 | 10 |
| MOC3011 | 250 | 10 | — | 7500 | 10 |
| MOC3012 | 250 | 5 | — | 7500 | 10 |
| MOC3020 | 400 | 30 | — | 7500 | 10 |
| MOC3021 | 400 | 15 | — | 7500 | 10 |
| MOC3022 | 400 | 10 | — | 7500 | 10 |
| MOC3023 | 400 | 5 | — | 7500 | 10 |
| MOC3031 | 250 | 15 | 20 | 7500 | 2000 |
| MOC3032 | 250 | 10 | 20 | 7500 | 2000 |
| MOC3033 | 250 | 5 | 20 | 7500 | 2000 |
| MOC3041 | 400 | 15 | 20 | 7500 | 2000 |
| MOC3042 | 400 | 10 | 20 | 7500 | 2000 |
| MOC3043 | 400 | 5 | 20 | 7500 | 2000 |
| MOC3061 | 600 | 15 | 20 | 7500 | 1500 |
| MOC3062 | 600 | 10 | 20 | 7500 | 1500 |
| MOC3063 | 600 | 5 | 20 | 7500 | 1500 |
| MOC3081 | 800 | 15 | 20 | 7500 | 1500 |
| MOC3082 | 800 | 10 | 20 | 7500 | 1500 |
| MOC3083 | 800 | 5 | 20 | 7500 | 1500 |

3

Logic Output (Style 5)

| Device | Threshold Current On mA Max | Threshold Current Off mA Min | $I_{F(off)}/I_{F(on)}$ | | V_{CC} | | t_r, t_f μ s Typ | VISO Vac Pk |
|---------|-----------------------------|------------------------------|------------------------|-----|----------|-----|------------------------|-------------|
| | | | Min | Max | Min | Max | | |
| H11L1 | 1.6 | 0.3 | 0.5 | 0.9 | 3 | 15 | 0.1 | 3535 |
| H11L2 | 10 | 0.3 | 0.5 | 0.9 | 3 | 15 | 0.1 | 3535 |
| MOC5007 | 1.6 | 0.3 | 0.5 | 0.9 | 3 | 15 | 0.1 | 7500 |
| MOC5008 | 4 | 0.3 | 0.5 | 0.9 | 3 | 15 | 0.1 | 7500 |
| MOC5009 | 10 | 0.3 | 0.5 | 0.9 | 3 | 15 | 0.1 | 7500 |

Optoisolators

Small Outline

Case 846-01

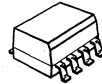

These optoisolators consist of a gallium arsenide infrared emitting diode optically coupled to a monolithic silicon detector, in a surface-mountable, small outline, SOIC-8 style plastic package. All are UL Recognized (File Number 54915) and

have a guaranteed isolation rating of 2500 volts (rms). They are ideally suited for high density applications, and eliminate the need for through-the-board mounting.

Transistor Output (Style 1)

Pinout: 1-Anode, 2-Cathode, 3-N.C., 4-N.C., 5-Emitter, 6-Collector, 7-Base, 8-N.C.

| Device | Current Transfer Ratio (CTR) | | VISO V(rms) | VCE(sat) | | | t_{on}/t_{off} Typ | | | $V_{(BR)CEO}$ Volts Min | V_F | | | |
|--------|------------------------------|------------|-------------|-----------|----------------------|----------|----------------------|----------------|----------------|-------------------------|----------------------|----------|-----|----|
| | % Min | @ I_F mA | | VCE Volts | Volts Max @ I_F mA | I_C mA | μ s @ I_C mA | V_{CC} Volts | R_L Ω | | Volts Max @ I_F mA | I_F mA | | |
| MOC205 | 40-80 | 10 | 10 | 2500 | 0.4 | 10 | 2 | 3/2.8 | 2 | 10 | 100 | 70 | 1.5 | 10 |
| MOC206 | 63-125 | 10 | 10 | 2500 | 0.4 | 10 | 2 | 3/2.8 | 2 | 10 | 100 | 70 | 1.5 | 10 |
| MOC207 | 100-200 | 10 | 10 | 2500 | 0.4 | 10 | 2 | 3/2.8 | 2 | 10 | 100 | 70 | 1.5 | 10 |
| MOC211 | 20 min | 10 | 10 | 2500 | 0.4 | 10 | 2 | 7.5/5.7 | 2 | 10 | 100 | 30 | 1.5 | 10 |
| MOC212 | 50 min | 10 | 10 | 2500 | 0.4 | 10 | 2 | 7.5/5.7 | 2 | 10 | 100 | 30 | 1.5 | 10 |
| MOC213 | 100 min | 10 | 10 | 2500 | 0.4 | 10 | 2 | 7.5/5.7 | 2 | 10 | 100 | 30 | 1.5 | 10 |
| MOC215 | 20 min | 1 | 5 | 2500 | 0.4 | 1 | 0.1 | 7.5/5.7 | 2 | 10 | 100 | 30 | 1.3 | 1 |
| MOC216 | 50 min | 1 | 5 | 2500 | 0.4 | 1 | 0.1 | 7.5/5.7 | 2 | 10 | 100 | 30 | 1.3 | 1 |
| MOC217 | 100 min | 1 | 5 | 2500 | 0.4 | 1 | 0.1 | 7.5/5.7 | 2 | 10 | 100 | 30 | 1.3 | 1 |

Darlington Output (Style 1)

Pinout: 1-Anode, 2-Cathode, 3-N.C., 4-N.C., 5-Emitter, 6-Collector, 7-Base, 8-N.C.

| Device | Current Transfer Ratio (CTR) | | VISO V(rms) | VCE(sat) | | | t_{on}/t_{off} Typ | | | $V_{(BR)CEO}$ Volts Min | V_F | | | |
|--------|------------------------------|------------|-------------|-----------|----------------------|----------|----------------------|----------------|----------------|-------------------------|----------------------|----------|-----|---|
| | % Min | @ I_F mA | | VCE Volts | Volts Max @ I_F mA | I_C mA | μ s @ I_F mA | V_{CC} Volts | R_L Ω | | Volts Max @ I_F mA | I_F mA | | |
| MOC221 | 100 min | 1 | 5 | 2500 | 1 | 1 | 0.5 | 3.5/95 | 5 | 10 | 100 | 30 | 1.3 | 1 |
| MOC222 | 200 min | 1 | 5 | 2500 | 1 | 1 | 0.5 | 3.5/95 | 5 | 10 | 100 | 30 | 1.3 | 1 |
| MOC223 | 500 min | 1 | 5 | 2500 | 1 | 1 | 0.5 | 3.5/95 | 5 | 10 | 100 | 30 | 1.3 | 1 |

VDE Approved 6-Pin DIP Optoisolators

VDE has approved Motorola's entire portfolio of DOME 6-pin DIP OPTOCOUPLEDERS against their Component Standard VDE0883 and has granted Motorola compliance with many VDE and IEC Equipment Standards per approval No. 41853 Nov. 26, 1985.

VDE approval is based on mechanical and electrical performance of the new "DOME" package shown in Figure 1. This 6-pin DIP package incorporates specially developed materials and assembly processes optimizing thermal and moisture stability while maintaining the high level of IRED life and isolation voltage. Most 6-pin DIP optocouplers are now made in this package, but in the near future, all will use the "DOME" construction.

VDE0833 Component Standard

Electrical ratings in this standard are:

Isolation withstand voltages:

3/50 VRMS, 1 min, $T_A = 100^\circ\text{C}$

5300 Vdc, 1 min, $T_A = 100^\circ\text{C}$

Isolation surge withstand voltage:

10 kV per IEC 65, 50 discharges

Isolation resistance:

$10^{11} \Omega$, 500 Vdc, $T_A = 100^\circ\text{C}$

Mechanical ratings are shown in the table below.

Equipment Standards Compliance

With the approval of the "DOME" package to the Component Standard VDE0883 combined with their VDE approval ratings, a wide range of Equipment Standards are covered. The following table summarizes the

optocouplers approved for many of the equipment standards and insulation levels.

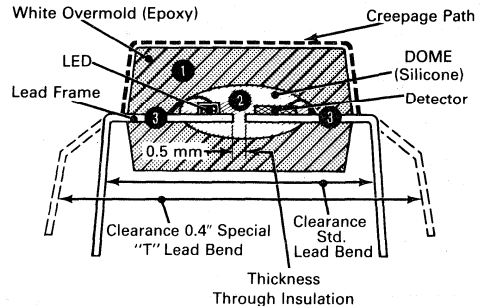

Figure 1. "DOME" Package

Two levels of electrical interface, or insulation, are used: 1. Reinforced, or safe, insulation; 2. Basic insulation.

Reinforced Insulation (sometimes referred to as "safe electrical isolation") is required in an optocoupler interfacing between a hazardous voltage circuit, like an ac line, and a **touchable safe extra low voltage (SELV)** circuit.

Basic Insulation is required in an optocoupler which interfaces between a hazardous voltage circuit and a **non-touchable, extra low voltage (ELV)** circuit.

Examples for Safety Applications for Motorola VDE Approved DOME Optoisolators

| Standard (2) | | Equipment | Requirements for reinforced (double) or safe insulation for equipment with an operating voltage up to 250 V rms (line voltage to ELV or SELV interfaces) | | | | |
|---------------------------------------|---------|---|--|----------------|-------------------|---------------------|----------------------|
| VDE | DIN IEC | | Creepage | Clearance (1) | Isolation Barrier | Dielectric Strength | Isolation Resistance |
| | | | [mm] | [mm] | [mm] | [kV RMS] | [Ω] |
| 0806 | 380 | Office Machines | 8 | 8 | 0.5 | 3.75 | 7×10^6 |
| 0805 | 435 | Data Processing | 8 | 8 | — | 3.75 | 7×10^6 |
| 0804 | — | Telecommunication | 8 | 8 | — | 2.50 | 2×10^6 |
| 0860 | 65 | Electrical Household | 6 | 6 | 0.4 | 3.0 (10)* | 4×10^6 |
| 0113 | 204 | Industrial Controls | 8 | 8 | — | 2.5 | 1×10^6 |
| 0160 | — | Power Installations with Electronic Equipment | 8 | 8 | — | 2.70 | 1×10^6 |
| 0832 | — | Traffic Light Controls | 8 | 8 | — | 2.50 | 4×10^6 |
| 0883 | — | Alarm Systems | 8 | 8 | — | 2.50 | 2×10^6 |
| 0831 | — | Electrical Signal System for Railroads | 8 | 8 | — | 2.0 | 2×10^6 |
| 0110 | — | General Std. for Electrical Equipment | 8 | 8 | — | 2.0 | — |
| 0883 | — | Optoisolator Comp. Std. | 8.5 | 8.3 (10.0) (1) | 0.5 | 3.75 (10)* | 10×10^{11} |
| VDE Rating for Motorola Optoisolators | | | | | | | |

All Motorola VDE Approved DOME Optoisolators meet or exceed the requirements of above listed VDE and DIN IEC Standards.

* Impulse discharge withstand voltage.

(1) To satisfy 8 mm creepage path on a PC board Motorola offers a special lead bend of 0.4 inch on all 6-pin dual-in-line optoisolators. Order by attaching "T" to the end of the Motorola part number.

(2) VDE standards (translated into English language) and IEC standards can be ordered from the American National Standard Institute ANSI 1430 Broadway, N.Y., N.Y. 10018, Sales Department, Phone 212-354-3300.

Optointerrupters

An Optointerrupter consists of an infrared emitting diode facing a photodetector in a molded plastic housing. A slot in the housing between the emitter and detector provides a means for interrupting the signal.

Motorola Optointerrupters are available in a wide selection of detector functions and housings to meet the specific needs of the system designer. The available variables are:

- **Detector Output;**
- **Package Outline;**
- **Performance Level.**

The various options are listed in the table below.

The generic number for Motorola Optointerrupters is **MOC7**. To construct the final device number for a specific unit, the generic number is followed by:

- a single Digit representing the desired output function;
- a single Letter representing the desired package;
- another single Digit indicating the desired performance level, as given in the table.

In accordance with this code, the sample Part Number at the bottom of the table (MOC75T2) represents a logic output interrupter in a flanged package with an LED trigger current of 15 mA.

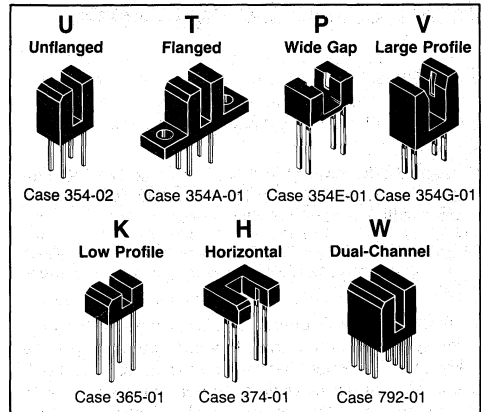

These standard Interrupter packages can be supplemented with custom packages. For details consult your Motorola Sales Representative.



Example of part number construction



| Output Function | Available Package Outlines | Performance Level | CTR @ I _F V _{CE} | Min (mA) | Max (V) | V _{CE(S) Max V @ I_F I_C} | (mA) | (mA) | LED Trigger Current (mA) | V _F Max V @ I _F (mA) | Output Voltage Range V Max |
|-----------------|----------------------------|-------------------|--------------------------------------|----------|---------|--|------|------|--------------------------|--|----------------------------|
| 0 Transistor | H, P, K, T, U, V | 1 | 5% | 20 | 5 | 0.4 | 30 | 1.8 | N/A | 1.8 50 | 30 |
| | | 2 | 10% | 20 | 5 | 0.4 | 20 | 1.8 | N/A | 1.8 50 | 30 |
| | | 3 | 20% | 20 | 5 | 0.4 | 20 | 1.8 | N/A | 1.8 50 | 30 |
| | W | 1 | 0.5% | 20 | 10 | 0.4 | 20 | .05 | N/A | 1.8 50 | 30 |
| | | 2 | 1.25% | 20 | 10 | 0.4 | 20 | .125 | N/A | 1.8 50 | 30 |
| 1 Darlington | H, P, T, U, V | 1 | 50% | 5 | 1.5 | 1 | 10 | 1.8 | N/A | 1.8 60 | 30 |
| | | 3 | 200% | 10 | 1.5 | 1 | 10 | 1.8 | N/A | 1.8 60 | 30 |
| | W | 1 | 50% | 5 | 5 | 1 | 10 | 1.8 | N/A | 1.8 60 | 30 |
| | | 750% | 10 | 5 | | | | | | | |
| 5 Logic | T, U | 1 | N/A | | N/A | | N/A | | 30 | 1.6 20 | 3-15 |
| | | 2 | N/A | | N/A | | N/A | | 15 | 1.6 20 | |

| | | | |
|-------|---|---|---|
| MOC 7 | 5 | T | 2 |
|-------|---|---|---|

MOC75T2 is a flanged, logic output interrupter with LED trigger current of 15 mA.

Transistor and Darlington* Outputs (V_{BR})_{CEO} = 30 V)

| Device | Current Transfer Ratio | | | V _{CE(sat)} | | | t _{on} /t _{off} μs Typ(1) | V _F | | Case/Style |
|--------|------------------------|---------------------|-------------------------|----------------------|---------------------|---------------------|---|----------------|---------------------|------------|
| | % Min | @ I _F mA | @ V _{CE} Volts | Volts Max | @ I _F mA | & I _C mA | | Volts Max | @ I _F mA | |
| H21A1 | 5 | 20 | 5 | 0.4 | 30 | 1.8 | 12/60 | 1.7 | 60 | 354A-01/1 |
| H21A2 | 10 | 20 | 5 | 0.4 | 20 | 1.8 | 12/60 | 1.7 | 60 | |
| H21A3 | 20 | 20 | 5 | 0.4 | 20 | 1.8 | 12/60 | 1.7 | 60 | |
| H21B1* | 75 | 10 | 1.5 | 1 | 10 | 1.8 | 125/150 | 1.7 | 60 | |
| H21B2* | 140 | 10 | 1.5 | 1 | 10 | 1.8 | 125/150 | 1.7 | 60 | |
| H21B3* | 250 | 10 | 1.5 | 1 | 10 | 1.8 | 125/150 | 1.7 | 60 | |
| H22A1 | 5 | 20 | 5 | 0.4 | 30 | 1.8 | 12/60 | 1.7 | 60 | 354-02/1 |
| H22A2 | 10 | 20 | 5 | 0.4 | 20 | 1.8 | 12/60 | 1.7 | 60 | |
| H22A3 | 20 | 20 | 5 | 0.4 | 20 | 1.8 | 12/60 | 1.7 | 60 | |
| H22B1* | 75 | 10 | 1.5 | 1 | 10 | 1.8 | 125/150 | 1.7 | 60 | |
| H22B2* | 140 | 10 | 1.5 | 1 | 10 | 1.8 | 125/150 | 1.7 | 60 | |
| H22B3* | 250 | 10 | 1.5 | 1 | 10 | 1.8 | 125/150 | 1.7 | 60 | |

Fiber Optic Components

Emitters

Motorola offers three families of emitters for fiber optic systems.

- **"High Performance"** family in hermetic Case 210 for systems requiring greater than 100 MHz analog bandwidth over several kilometers.
- **"MOD-LINE"** family in plastic Case 366 provides moderate performance (60 MHz) over moderate distances (500 meters).
- **"FLCS"** family in unique FLCS package is designed for applications requiring low cost, speeds up to 10 MHz and distances under 2000 meters. (The FLCS package serves as its own connector.) It is used with inexpensive 1000 micron core fiber (Eska SH4001).

Detectors

Detectors are available with a variety of output configurations that greatly affect Bandwidth and Responsivity.

All Motorola fiber optic components, except the FLCS family, are designed for use with 100 micron (or larger) core glass fiber and fit directly into the following industry standard connector systems. AMP #228756-1, AMPHENOL #905-138-5001, OFTI #PCR001.

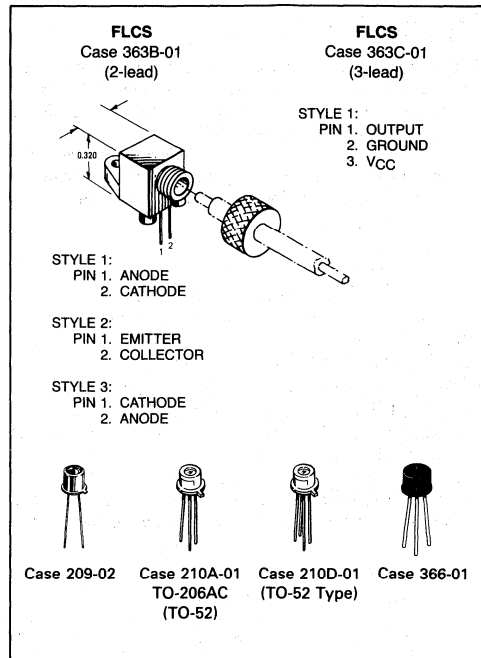

Emitters

| Device | Total Power Output | | | Response Time | | λ nm Typ | Case/Style |
|----------|--------------------|---|-------------------|-----------------------------|-----------------------------|------------------------|------------|
| | mW Typ | @ | I _F mA | t _r ns Typ | t _f ns Typ | | |
| MFOE71 | 3.5 | | 100 | 25 | 25 | 850 | 363B-01/1 |
| MFOE76 | 3.5 | | 100 | 250 | 250 | 660 | |
| MFOE200 | 3 | | 100 | | | 940 | 209-02/1 |
| MFOE1100 | 2.6 | | 100 | 15 | 16 | 850 | 210A-01/1 |
| MFOE1101 | 4 | | 100 | 15 | 16 | 850 | |
| MFOE1102 | 5 | | 100 | 15 | 16 | 850 | |
| MFOE1200 | 0.9 | | 100 | 5 | 5 | 850 | 210A-01/1 |
| MFOE1201 | 1.5 | | 100 | 2.8 | 3.5 | 850 | |
| MFOE1202 | 2.4 | | 100 | 2.8 | 3.5 | 850 | |
| MFOE1203 | 2.8 | | 100 | 2.8 | 3.5 | 850 | |
| MFOE3100 | 0.85 | | 50 | 19 | 14 | 850 | 366-01/1 |
| MFOE3101 | 1.65 | | 50 | 19 | 14 | 850 | |
| MFOE3200 | 1 | | 50 | 2.8 | 3.5 | 850 | 366-01/1 |
| MFOE3201 | 1.8 | | 50 | 2.8 | 3.5 | 850 | |
| MFOE3202 | 2.5 | | 50 | 2.8 | 3.5 | 850 | |

FIBER OPTIC COMPONENTS (continued)

Photodetectors

| Device | BWE MHz | Responsivity $\mu\text{A}/\mu\text{W}$ Typ | Response Time μs Typ | | $V_{(BR)}$ Volts Min | Case/Style |
|-------------------------|------------|--|------------------------------------|----------------------|----------------------------|------------|
| | | | t_{on}^* t_r | t_{off}^* t_f | | |
| Photo PIN Diodes | | | | | | |
| MFOD1100 | 350 | 0.35 | 0.5 ns | 0.5 ns | 50 | 210A-01/1 |
| MFOD3100 | 70 | 0.3 | 2 ns | 2 ns | 50 | 366-01/2 |
| MFOD71 | 70 | 0.2 | 1* ns | 1* ns | 100 | 363B-01/3 |
| Phototransistors | | | | | | |
| MFOD72 | 6 kHz | 125 | 10* | 60* | 30 | 363B-01/2 |
| Photodarlington | | | | | | |
| MFOD73 | 2 kHz | 1500 | 125* | 150* | 60 | 363B-01/2 |
| Detector Preamp | | $\text{mV}/\mu\text{W}$ | | | VCC Range | |
| MFOD2404 | 10 | 35 | 0.035 | 0.035 | 4-6 | 210D-01/1 |
| MFOD2405 | 35 | 6.0 | 0.010 | 0.010 | 4-6 | |

Logic Level Output

| Device | Light Required to Trigger - H(on) (VCC = 5 V) μW Typ | Response Time | | Hysteresis Ratio H(on)/H(off) Typ | Case/Style |
|----------|---|-------------------------------|--------------------------------|---|------------|
| | | t_{on} μs Typ | t_{off} μs Typ | | |
| MFOD75 | 6 | 0.4 | 0.8 | 0.75 | 363C-01/1 |
| MFOD3510 | 4 | 0.4 | 0.8 | 0.75 | 366-01/3 |

3

Opto — Chip Geometries

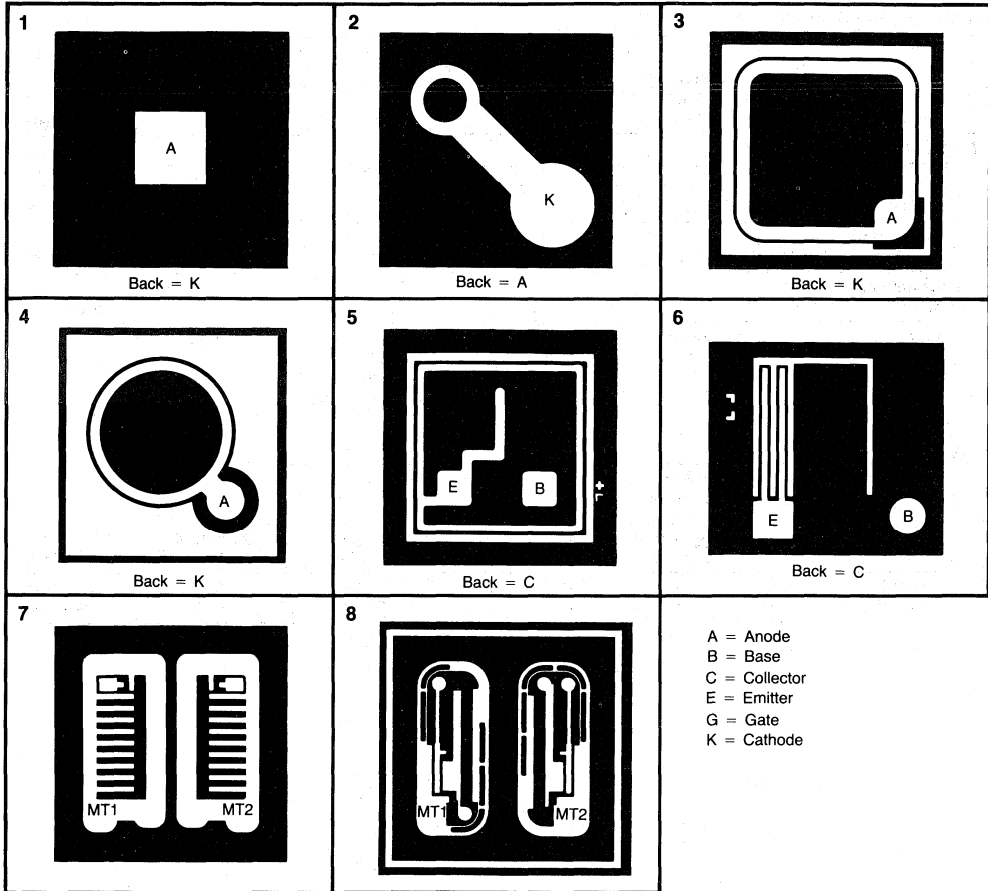

Opto Chips

Front Metallization Thickness — a minimum of 10,000 Å
 Back Metallization Thickness — a minimum of 15,000 Å

MECHANICAL SPECIFICATIONS

| Type | Chip Part # | Die Geometry Reference # | Die Size Mils | Die Thickness Mils | Bond Pad Size | | Metallization | | Packaging | | |
|------------|-------------|--------------------------|---------------|--------------------|---------------|--------------|---------------|------|--------------|------------|-------------|
| | | | | | Mils Anode | Mils Cathode | Front | Back | Multi (none) | Wafer (WP) | Circle (CP) |
| Pin Diode | MRDC100 | 3 | 30x30 | 8-10 | 4.5x4.5 | 30x30 | Al | Au | * | * | * |
| Transistor | MRDC200 | 5 | 25x25 | 8-10 | Emitter | Base | Al | Au | * | * | * |
| | | | | | 3.5x3.5 | 3.5x3.5 | | | | | |

Samples available upon request, contact the Motorola Sales Office.

*Available Packaging
 — Not Available

(continued)

Opto Chips — continued

MECHANICAL SPECIFICATIONS (continued)

| Type | Chip Part # | Die Geometry Reference # | Die Size Mils | Die Thickness Mils | Bond Pad Size | | Metallization | | Packaging | | |
|-------------------------|-------------|--------------------------|---------------|--------------------|---------------|-----------|---------------|------|--------------|------------|-------------|
| | | | | | Mils Emitter | Mils Base | Front | Back | Multi (none) | Wafer (WP) | Circle (CP) |
| Darlington | MRDC400 | 6 | 27x27 | 8-10 | 4.0x4.0 | 4.0 dia. | Al | Au | * | * | * |
| | | | | | MT1 | MT2 | | | | | |
| Zero Cross Triac Driver | MRDC600 | 8 | 45x45 | 8-10 | 4.6 dia. | 4.6 dia. | Al | Au | * | * | * |
| Triac Driver | MRDC800 | 7 | 40x40 | 8-10 | 4.0x5.0 | 4.0x5.0 | Al | Au | * | * | * |
| | | | | | Anode | Cathode | | | | | |
| LED (940 nm) | MLEDC1000 | 1 | 16x16 | 8-10 | 4x4 | 16x16 | Al | Au | * | * | * |
| | | | | | Anode | Cathode | | | | | |
| LED (850 nm) | MFOEC1200 | 2 | 24x24 | 8-10 | 24x24 | 3.5 dia. | Al | Au | * | * | * |
| | | | | | Anode | Cathode | | | | | |
| F.O. Pin Diode | MFODC1100 | 4 | 30x30 | 8-10 | 4.0 dia. | 30x30 | Al | Au | * | * | * |

Samples available upon request, contact the Motorola Sales Office.

*Available Packaging
— Not Available

ELECTRICAL SPECIFICATIONS

| Parameter | Symbol | Min | Typ | Max | Unit |
|---|---------------|-----|-----|-----|------------------------|
| MRDC100 Responsivity ($V_R = 20$ V, $\lambda = 850$ nm) | R | 0.3 | 0.4 | — | μ A/ μ W |
| Dark Current ($V_R = 20$ V, $H = 0$) | I_D | — | — | 10 | nA |
| MRDC200 Light Current ($V_{CE} = 5$ V, $H = 5$ mW/cm ²) | I_L | 0.8 | — | 22 | mA |
| Collector-Emitter Breakdown Voltage ($I_C = 100$ μ A) | $V_{(BR)CEO}$ | 40 | — | — | Volts |
| MRDC400 Light Current ($V_{CE} = 5$ V, $H = 1$ mW/cm ²) | I_L | 0.8 | — | 20 | mA |
| Collector-Emitter Breakdown Voltage ($I_C = 1$ mA) | $V_{(BR)CEO}$ | 45 | — | — | Volts |
| MRDC600 Light Required to Trigger ($\lambda = 940$ nm, $V_{TM} = 3$ V, $R_L = 150$ Ω) | H_{FT} | — | 5 | 10 | mW/ cm ² |
| Peak Repetitive Current ($P_W = 100$ μ s, 120 pps) | I_T | — | — | 300 | mA |
| Off-State Output Terminal Voltage | V_{DRM} | — | — | 600 | Volts |
| Peak Blocking Current ($V_{DRM} = 600$ V) | I_{DRM} | — | 60 | 500 | nA |

| Parameter | Symbol | Min | Typ | Max | Unit |
|--|-------------|-----|-----|-----|------------------------|
| MRDC600 (continued) Inhibit Voltage ($H = 20$ mW/cm ² , MT1-MT2; voltage above which device will not trigger) | V_{IH} | — | 10 | 20 | Volts |
| MRDC800 Light Required to Trigger ($\lambda = 940$ nm, $V_{TM} = 3$ V, $R_L = 150$ Ω) | H_{FT} | — | 5 | 10 | mW/ cm ² |
| On-State RMS Current (Full Cycle 50-60 Hz) | $I_T(RMS)$ | — | — | 100 | mA |
| Off-State Output Terminal Voltage | V_{DRM} | — | — | 400 | Volts |
| Peak Blocking Current ($V_{DRM} = 400$ V) | I_{DRM} | — | 10 | 100 | nA |
| MFOEC1200 Peak Wavelength ($I_F = 100$ mAdc) | λ_p | — | 850 | — | nm |
| Total Power Out ($I_F = 100$ mA) | P_O | 1.5 | — | — | mW |
| Forward Voltage ($I_F = 100$ mA) | V_F | 1 | — | 2.5 | Volts |
| MLEDC1000 Peak Wavelength ($I_F = 50$ mA) | λ_p | — | 940 | — | nm |
| Total Power Out ($I_F = 50$ mA) | P_O | 2 | — | — | mW |
| Forward Voltage ($I_F = 50$ mA) | V_F | — | — | 1.5 | Volts |

3

Cross-Reference

The following cross-reference is meant to serve as a substitution guide for existing competitive devices to Motorola's optoelectronic product line.

Motorola's nearest equivalent devices are selected on the basis of general similarity of electrical characteristics and mechanical configuration. Before using a substitute,

please compare the detailed specifications of the substitute device to the data sheet of the original device.

CODE

- A = Direct Replacement
- B = Minor Electrical Difference
- C = Minor Mechanical Difference
- D = Significant Electrical Difference
- E = Significant Mechanical Difference

| Industry Device | Motorola Equivalent | Code | Industry Device | Motorola Equivalent | Code | Industry Device | Motorola Equivalent | Code |
|-----------------|---------------------|------|-----------------|---------------------|------|-----------------|---------------------|------|
| BP101 | MRD3050 | C | GS800,3,6,9,10 | MRD300 | A | MCP3031 | MOC3031 | A |
| BP102 | MRD3050 | C | GS612 | MRD3050 | A | MCP3032 | MOC3032 | A |
| BPW14 | MRD900 | A | GS670 | MRD3050 | A | MCP3033 | MOC3033 | A |
| BPW15 | MRD602 | A | GS680 | MRD300 | A | MCP3040 | MOC3041 | A |
| BPW24 | MRD701 | E | GS683 | MRD300 | A | MCP3041 | MOC3041 | A |
| BPW30 | MRD3050 | A | GS686 | MRD300 | A | MCP3042 | MOC3042 | A |
| BPW39A | MRD701 | B,C | H11A1,2,3,4,5 | H11A1,2,3,4,5 | A | MCP3043 | MOC3043 | A |
| BPX25A | MRD370 | A | H11A520 | H11A520 | A | MCS2 | MOC3002 | A |
| BPX25 | MRD900 | A | H11A550 | H11A550 | A | MCS21 | MOC3003 | A |
| BPX29A | MRD370 | A | H11A5100 | H11A5100 | A | MCS2400 | MOC3020 | D,E |
| BPX29 | MRD310 | A | H74A1 | 4N26 | B | MCS2401 | MOC3001 | A |
| BPX37 | MRD300 | A | H11AA1,2,3,4 | H11AA1,2,3,4 | A | MCT2 | MCT2 | A |
| BPX38 | MRD3055 | A | H11AV1A | H11AV1A | A | MCT2E | MCT2E | A |
| BPX43 | MRD300 | A | H11AV2A | H11AV2A | A | MCT26 | 4N26 | A |
| BPX58 | MRD300 | A | H11AV3A | H11AV3A | A | MCT270 | 4N35 | B |
| BPX59 | MRD360 | A | H11B1,2,3 | H11B1,2,3 | A | MCT271 | MCT271 | A |
| BPY62 | MRD3055 | A | H11B255 | H11B255 | A | CNY17-2 | CNY17-2 | B |
| CL100 | MLED930 | B | H11C1,2,3 | H11C1,2,3 | A | CNY17-3 | CNY17-3 | B |
| CL110 | MLED930 | A | H11C4,5,6 | H11C4,5,6 | A | MCT275 | MCT275 | A |
| CL110A | MLED930 | A | H11D1,2,3,4 | H11D1,2,3,4 | A | MCT276 | CNY17-1 | A |
| CL110B | MLED930 | B | H11G1,2,3 | H11G1,2,3 | A | MCT277 | 4N35 | A |
| CL1-2 | 4N38 | B | H11J1 | MOC3011 | A | MCT2200 | 4N35 | B |
| CL1-3 | 4N35 | B | H11J2 | MOC3010 | A | MCT2201 | 4N35 | B |
| CL1-5 | 4N26 | A | H11J3 | MOC3011 | A | MCT2202 | CNY17-2 | B |
| CL1-10 | 4N33 | A | H11J4 | MOC3010 | A | MEK730 | MLED81 | B |
| CLR2050 | MRD3050 | A | H11J5 | MOC3010 | A | MEK760 | MLED81 | B |
| CLR2060 | MRD360 | A | H11L1,2 | H11L1,2 | A | MES560 | MLED77 | B,C |
| CLR2110 | MRD310 | A | H21A1,2,3 | H21A1,2,3 | A | MES760 | MLED71 | A |
| CLR2140 | MRD310 | A | H21B1,2,3 | H21B1,2,3 | A | MFOD71 | MFOD71 | A |
| CLR2150 | MRD300 | A | H22A1,2,3 | H22A1,2,3 | A | MFOD72 | MFOD72 | A |
| CLR2160 | MRD300 | A | H22B1,2,3 | H22B1,2,3 | A | MFOD73 | MFOD73 | A |
| CLR2170 | MRD370 | A | H74C1 | H74C1 | A | MFOD75 | MFOD75 | A |
| CLR2180 | MRD360 | A | H74C2 | MOC3020 | DE | MFOD100 | MRD500 | A |
| CNY17 | CNY17 | A | IL1 | IL1 | A | MFOD102F | MFOD1100 | E |
| CNY17-1 | CL5 | A | IL5 | 4N25 | B | MFOD104F | MFOD1100 | E |
| CNY17-2 | CNY17-2 | A | IL12 | IL12 | A | MFOD110F | MFOD1100 | E |
| CNY17-3 | CNY17-3 | A | IL15 | IL15 | A | MFOD200 | MFOD200 | A |
| CNY18 | 4N25 | A | IL16 | IL16 | A | MFOD202F | MFOD1100 | E |
| CNY21 | 4N25 | E | IL74 | IL74 | A | MFOD300 | MFOD300 | A |
| CNY36 | MOC70U1 | B,C | IL205 | MOC205 | A | MFOD302F | MFOD1100 | E |
| CNY37 | MOC70T1 | B,C | IL206 | MOC206 | A | MFOD404F | MFOD2404 | A |
| CQY10 | MLED930 | B | IL207 | MOC207 | A | MFOD405F | MFOD2405 | A |
| CQY11,B,C | MLED930 | B | IL211 | MOC211 | A | MFOD1100 | MFOD1100 | A |
| CQY12,B | MLED930 | B | IL212 | MOC212 | A | MFOD2202 | MFOD1100 | A |
| CQY13 | 4N26 | B | IL213 | MOC213 | A | MFOD2302 | MFOD1100 | A |
| CQY14 | 4N25 | B | IL215 | MOC215 | A | MFOD2404 | MFOD2404 | A |
| CQY15 | 4N26 | B | IL216 | MOC216 | A | MFOD2405 | MFOD2405 | A |
| CQY31 | MLED930 | B | IL217 | MOC217 | A | MFOD3100 | MFOD3100 | A |
| CQY32 | MLED930 | B | IL221 | MOC221 | A | MFOD3510 | MFOD3510 | A |
| CQY40,41 | 4N26 | A | IL222 | MOC222 | A | MFODC1100 | MFODC1100 | A |
| CQY80 | MOC1005 | B | IL223 | MOC223 | A | MFOE71 | MFOE71 | A |
| CQY99 | MLED81 | B | IL250 | H11AA1 | A | MFOE76 | MFOE76 | A |
| EP2 | 4N25 | B | ILA30 | 4N33 | B | MFOE102F | MFOD1200 | E |
| EPY62-1 | MRD3055 | A | ILA55 | 4N33 | B | MFOE103F | MFOD1200 | E |
| EPY62-2 | MRD3055 | A | ILCA2-30 | MCA230 | A | MFOE106F | MFOD1200 | E |
| EPY62-3 | MRD310 | A | ILCA2-55 | H11B255 | A | MFOE107F | MFOD1201 | E |
| FCD810,A,B,C,D | 4N28 | A | IRL40 | MLED930 | D | MFOE108F | MFOD1202 | E |
| FCD820,A,B,C,D | TIL116 | A | LB, L9 | MRD3011 | B | MFOE200 | MFOE200 | A |
| FCD825,A,B,C,D | TIL117 | B | L14F1 | MRD360 | A | MFOE1100 | MFOD1100 | A |
| FCD830,A,B,C,D | TIL116 | B | L14F2 | MRD370 | A | MFOE1101 | MFOD1101 | A |
| FCD831,A,B,C,D | TIL116 | B | L14G1 | MRD300 | A | MFOE1102 | MFOD1102 | A |
| FCD836,C,D | 4N28 | B | L14G2,3 | MRD310 | A | MFOE1200 | MFOD1200 | A |
| FCD850,C,D | 4N29 | B | L14H1,2,3,4 | MRD701 | DE | MFOE1201 | MFOD1201 | A |
| FCD855,C,D | H11B255 | A | LED56,F | MLED930 | A | MFOE1202 | MFOD1202 | A |
| FCD860,C,D | Special | A | MAH120 | MRD360 | B,C | MFOE3100 | MFOD3100 | A |
| FPE100 | MLED930 | B | H11G1 | H11G1 | A | MFOE3101 | MFOD3101 | A |
| FPE410 | MLED930 | B | MCA11G2 | H11G2 | A | MFOE3102 | MFOD3102 | A |
| FPE500 | MLED930 | B | MCA230 | MCA230 | A | MFOE3200 | MFOD3200 | A |
| FPE520 | MFOE200 | D | MCA231 | MCA231 | A | MFOE3201 | MFOD3201 | A |
| FPT120,C | MRD300 | B | MCA255 | MCA255 | A | MFOE3202 | MFOD3202 | A |
| FPT400 | MRD360 | A | MCA230 | MCA230 | A | MFOE3200 | MFOD3200 | A |
| FPT500,A | MRD300 | A | MCA2231 | 4N33 | B | MLED15 | MLED71 | A |
| FPT510 | MRD3054 | A | MCA2255 | 4N33 | B | MLED71 | MLED71 | A |
| FPT510A | MRD3055 | A | MCP3009 | MOC3009 | A | MLED76 | MLED76 | A |
| FPT520 | MRD300 | A | MCP3010 | MOC3010 | A | MLED77 | MLED77 | A |
| FPT520A | MRD300 | A | MCP3011 | MOC3011 | A | MLED81 | MLED81 | A |
| FPT530A | MRD300 | B | MCP3012 | MOC3012 | A | MLED92 | MLED71 | E |
| FPT450A | MRD300 | B | MCP3020 | MOC3020 | A | MLED93 | MLED71 | E |
| FPT550A | MRD300 | B | MCP3021 | MOC3021 | A | MLED94 | MLED71 | E |
| FPT560 | MRD300 | B | MCP3022 | MOC3022 | A | MLED95 | MLED71 | E |
| FPT570 | MRD360 | A | MCP3023 | MOC3023 | A | MLED930 | MLED930 | A |
| GG686 | MRD300 | A | MCP3030 | MOC3031 | A | MLED1000 | MLED1000 | A |

CROSS REFERENCE (Continued)

| Industry Device | Motorola Equivalent | Code | Industry Device | Motorola Equivalent | Code | Industry Device | Motorola Equivalent | Code |
|-----------------|---------------------|------|-------------------|---------------------|------|-----------------|---------------------|------|
| MOC70H1.2,3 | MOC70H1.2,3 | A | MOC8205 | MOC8204 | A | SD5442-1,-2,-3 | MRD300 | B |
| MOC70K1.2,3 | MOC70K1.2,3 | A | MOC8206 | MOC8204 | A | SE1450 series | MLED910 | E |
| MOC70P1.2,3 | MOC70P1.2,3 | A | MRD14B | MRD711 | E | SE2450 series | MLED910 | B |
| MOC70T1.2,3 | MOC70T1.2,3 | A | MRD150 | MRD150 | A | SE2460 series | MLED910 | B |
| MOC70U1.2,3 | MOC70U1.2,3 | A | MRD300 | MRD300 | A | SE5450 series | MLED910 | A |
| MOC70W1.2,3 | MOC70W1.2,3 | A | MRD310 | MRD310 | A | SE5451 series | MLED910 | B |
| MOC71H1.3 | MOC71H1.2,3 | A | MRD360 | MRD360 | A | SG1001 series | MLED910 | B |
| MOC71P1.3 | MOC71P1.2,3 | A | MRD370 | MRD370 | A | SPX2 | 4N35 | A |
| MOC71T1.3 | MOC71T1.2,3 | A | MRD500 | MRD500 | A | SPX2E | 4N35 | A |
| MOC71U1.3 | MOC71U1.2,3 | A | MRD510 | MRD510 | A | SPX4,5,6 | 4N35 | A |
| MOC71V1.3 | MOC71V1.2,3 | A | MRD701 | MRD701 | A | SPX25 | 4N27 | A |
| MOC71W1 | MOC71W1 | A | MRD711 | MRD711 | A | SPX28 | 4N27 | A |
| MOC75T1.2 | MOC75T1.2 | A | MRD721 | MRD721 | A | SPX35 | 4N35 | A |
| MOC119 | MOC119 | A | MRD730 | MRD3011 | A | SPX36 | 4N35 | A |
| MOC601A,B | 4N27 | A | MRD750 | MRD750 | A | SPX37 | 4N35 | A |
| MOC602A,B | 4N25 | A | MRD821 | MRD821 | A | SPX53 | H11AA550 | A |
| MOC603A,B | 4N35 | A | MRD3010 | MRD3010 | A | SPX103 | 4N35 | A |
| MOC604A,B | 4N35 | A | MRD3011 | MRD3011 | A | SPX1872-1 | MOC70U1 | C |
| MOC622A | 4N29 | A | MRD3050 | MRD3050 | A | SPX1872-2 | MOC70U1 | C |
| MOC623A | 4N32 | A | MRD3051 | MRD3051 | A | SPX1873-1 | MOC70T1 | C |
| MOC624A | 4N32 | A | MRD3054 | MRD3054 | A | SPX1873-2 | MOC70T1 | C |
| MOC625A | H1162 | A | MRD3055 | MRD3055 | A | SPX1876-1 | MOC70T1 | C |
| MOC626A | MOC8030 | A | MRD3056 | MRD3056 | A | SPX1876-2 | MOC70T1 | C |
| MOC627A | MOC8050 | A | MRD5009 | MRD5009 | A | SPX2762-4 | MOC70U2 | C |
| MOC628A | MOC8050 | A | MRDC100 | MRDC100 | A | SPX2721 | CNY17-1 | A |
| MOC629A | MOC8021 | A | MRDC200 | MRDC200 | A | SPX2722 | CNY17-2 | A |
| MOC633A,B | MOC3020 | A | MRDC400 | MRDC400 | A | SPX2723 | CNY17-3 | A |
| MOC634A,B | MOC3021 | A | MRDC500 | MRDC500 | A | SSL4,5 | MLED930 | B |
| MOC635A,B | MOC3022 | A | MRDC900 | MRDC900 | A | SSL34,54 | MLED930 | B |
| MOC640A,B | MOC3041 | A | MTH320.1 | MRD300 | B,C | STP51 | MRD3050 | A |
| MOC641A,B | MOC3041 | A | MTH420.1 | MRD300 | B,C | STP53 | MRD3056 | A |
| MOC660B | MOC3061 | A | MTS360.1 | MRD701 | B,C | STPT80 | MRD3056 | A |
| MOC661B | MOC3061 | A | MTS360.1 | MRD701 | B,C | STPT81 | MRD3052 | A |
| MOC682B | MOC3082 | A | OP131 | MLED930 | A | STPT82 | MRD3053 | A |
| MOC680B | MOC3081 | A | OP160,SL,SLA | MLED81 | A | STPT83 | MRD3054 | A |
| MOC681B | MOC3081 | A | OP800 | MLED81 | A | STPT84 | MRD3056 | A |
| MOC682B | MOC3082 | A | OP800 | MRD3055 | A | STPT260 | MRD360 | A |
| MOC1000 | 4N26 | A | OP801 | MRD3050 | A | STPT300 | MRD300 | A |
| MOC1001 | 4N26 | A | OP802 | MRD310 | A | STPT310 | MRD360 | C |
| MOC1002 | 4N27 | A | OP803 | MRD300 | A | TIL23 | MLED910 | A |
| MOC1003 | 4N28 | A | OP804 | MRD300 | A | TIL24 | MLED910 | B |
| MOC1005 | 4N26 | A | OP805 | MRD300 | A | TIL31 | MLED930 | B |
| MOC1006 | 4N26 | A | OP830 | MRD300 | A | TIL33 | MLED930 | B |
| MOC1006 | 4N38 | A | OP110 | MOC1005 | DE | TIL34 | MLED930 | A |
| MOC1200 | 4N29 | A | OP1250 | 4N26 | A | TIL63 | MRD3050 | A |
| MOC3000 | MOC3000 | A | OP1251 | 4N28 | A | TIL64 | MRD3050 | A |
| MOC3001 | MOC3001 | A | OP1252 | 4N26 | A | TIL65 | MRD3052 | A |
| MOC3002 | MOC3002 | A | OP1253 | TIL117 | A | TIL66 | MRD3054 | A |
| MOC3003 | MOC3003 | A | OP1254 | 4N26 | A | TIL67 | MRD3056 | A |
| MOC3007 | MOC3007 | A | OP1255 | 4N35 | A | TIL81 | MRD300 | A |
| MOC3009 | MOC3009 | A | OP1256 | 4N28 | A | TIL111 | TIL111 | A |
| MOC3010 | MOC3010 | A | OP1257 | 4N28 | A | TIL112 | TIL112 | A |
| MOC3011 | MOC3011 | A | OP1258 | 4N26 | A | TIL113 | TIL113 | A |
| MOC3012 | MOC3012 | A | OP1259 | TIL117 | A | TIL114 | 4N35 | A |
| MOC3020 | MOC3020 | A | OP1254 | TIL117 | A | TIL115 | 4N35 | A |
| MOC3021 | MOC3021 | A | OP1255 | 4N35 | A | TIL116 | TIL116 | A |
| MOC3022 | MOC3022 | A | OP1256 | H11AA1 | A | TIL117 | TIL117 | A |
| MOC3023 | MOC3023 | A | OP1300 | MOC3009 | A | TIL118 | 4N35 | A |
| MOC3030 | MOC3031 | A | OP1301 | MOC3010 | A | TIL119 | TIL119 | A |
| MOC3031 | MOC3031 | A | OP1302 | MOC3011 | A | TIL124 | 4N35 | A |
| MOC3032 | MOC3032 | A | OP1303 | MOC3012 | A | TIL125 | 4N35 | A |
| MOC3033 | MOC3033 | A | OP1304 | MOC3020 | A | TIL126 | TIL126 | A |
| MOC3040 | MOC3041 | A | OP1305 | MOC3021 | A | TIL127 | 4N33 | A |
| MOC3041 | MOC3041 | A | OP1306 | MOC3022 | A | TIL128 | MOC8111 | A |
| MOC3042 | MOC3042 | A | OP1307 | MOC3023 | A | TIL153 | 4N35 | A |
| MOC3043 | MOC3043 | A | OP1308 | MOC3031 | A | TIL154 | 4N35 | A |
| MOC3060 | MOC3061 | A | OP1309 | MOC3031 | A | TIL155 | 4N35 | A |
| MOC3061 | MOC3061 | A | OP1310 | MOC3032 | A | TLF501 | 4N27 | A |
| MOC3062 | MOC3062 | A | OP1311 | MOC3033 | A | TLF503 | 4N25 | B |
| MOC3063 | MOC3063 | A | OP1312 | MOC3041 | A | TLF504 | 4N25 | B |
| MOC3080 | MOC3081 | A | OP1313 | MOC3041 | A | 2N5777 | MRD711 | DE |
| MOC3081 | MOC3081 | A | OP1314 | MOC3042 | A | 2N5778 | MRD711 | DE |
| MOC3082 | MOC3082 | A | OP1315 | MOC3043 | A | 2N5779 | MRD711 | DE |
| MOC3083 | MOC3083 | A | OP1316 | 4N33 | A | 2N5780 | MRD711 | DE |
| MOC5007 | MOC5007 | A | OP1317 | 4N33 | A | 2N25.A | 4N25.A | A |
| MOC5008 | MOC5008 | A | OP1318 | 4N33 | A | 4N25.A | 4N25.A | A |
| MOC5009 | MOC5009 | A | OP1319 | 4N33 | A | 4N26 | 4N26 | A |
| MOC7811 | MOC70T1 | A | OP14201 | H11C1 | A | 4N27 | 4N27 | A |
| MOC7812 | MOC70T2 | A | OP14202 | H11C3 | A | 4N28 | 4N28 | A |
| MOC7813 | MOC70T3 | A | OP1500 | H11A520 | A | 4N29.A | 4N29.A | A |
| MOC7821 | MOC70U1 | A | OP1510 | H11A520 | A | 4N30 | 4N30 | A |
| MOC7822 | MOC70U2 | A | OP1600 | MOC8204 | A | 4N31 | 4N31 | A |
| MOC7823 | MOC70U3 | A | OP1610 | MOC8204 | A | 4N32 | 4N32 | A |
| MOC8020 | MOC8020 | A | OP18015 | MOC5009 | A | 4N32A | 4N32 | A |
| MOC8021 | MOC8021 | A | FC503 | 4N26 | A | 4N33 | 4N33 | A |
| MOC8030 | MOC8030 | A | SCS11C1 | H11C1 | A | 4N35 | 4N35 | A |
| MOC8050 | MOC8050 | A | SCS11C3 | H11C3 | A | 4N36 | 4N36 | A |
| MOC8080 | MOC8080 | A | SD1440-1,-2,-3,-4 | MRD3050 | DE | 4N37 | 4N37 | A |
| MOC8100 | MOC8100 | A | SD3420-1,-2 | MRD510 | A | 4N38.A | 4N38.A | A |
| MOC8101 | MOC8101 | A | SD5400-1 | MRD370 | A | 4N39 | 4N39 | A |
| MOC8102 | MOC8102 | A | SD5400-2 | MRD360 | A | 4N40 | 4N40 | A |
| MOC8103 | MOC8103 | A | SD5420-1 | MRD360 | A | 5082-4203 | MRD500 | A |
| MOC8104 | MOC8104 | A | SD5420-2 | MRD500 | A | 5082-4204 | MRD500 | A |
| MOC8111 | MOC8111 | A | SD5440-1 | MRD3052 | A | 5082-4207 | MRD500 | A |
| MOC8112 | MOC8112 | A | SD5440-2 | MRD3056 | A | 5082-4220 | MRD500 | A |
| MOC8113 | MOC8113 | A | SD5440-3 | MRD300 | A | | | |
| MOC8204 | MOC8204 | A | SD5440-4 | MRD300 | B | | | |



3

Discrete Emitters/Detectors Data Sheets

4

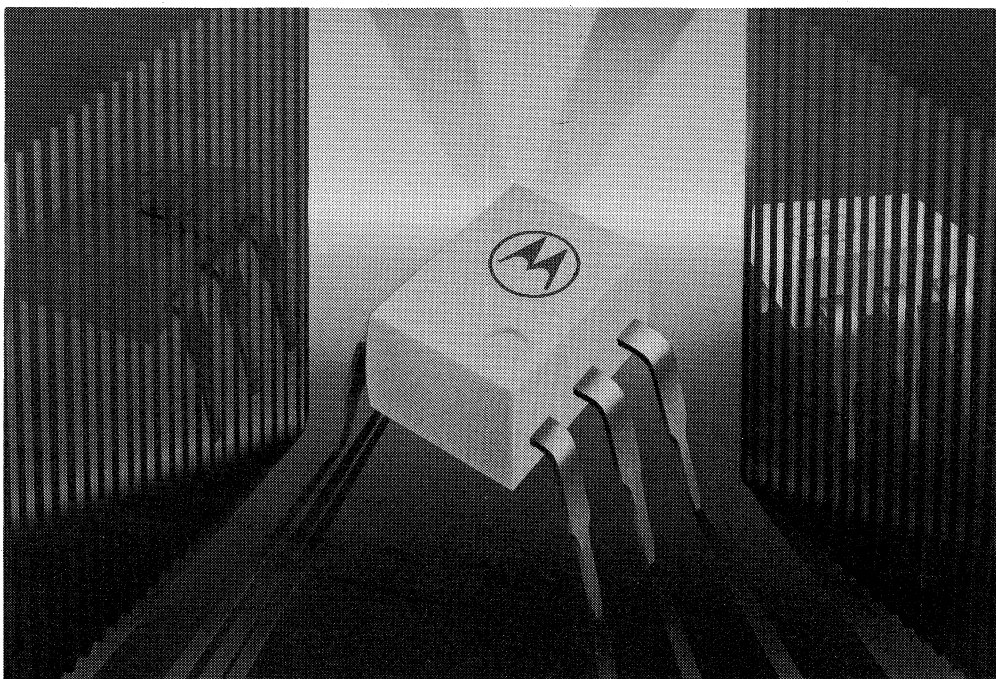

Infrared LED

This device is designed for a wide variety of infrared applications, including keyboards, end-of-tape sensors, coin or paper handlers, and other general sensing applications. The MLED71 can be used in conjunction with any MRD700 series detector. It features high power output, using gallium arsenide technology.

- Low Cost
- Popular Case 349 Package, with Molded Lens
- Uses Stable Long-Life LED Technology
- Clear Epoxy Package

MLED71

**INFRARED
LED
940 nm**

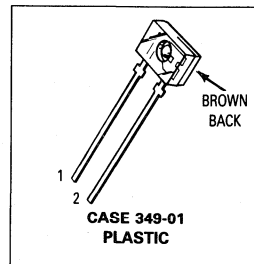

MAXIMUM RATINGS

| Rating | Symbol | Value | Unit |
|--|-----------|-------------|----------------------------|
| Reverse Voltage | V_R | 6 | Volts |
| Forward Current — Continuous | I_F | 50 | mA |
| Forward Current — Peak Pulse | I_F | 1 | A |
| Total Power Dissipation @ $T_A = 25^\circ\text{C}$ (Note 1) Derate above 55°C | P_D | 90 2 | mW mW/ $^\circ\text{C}$ |
| Ambient Operating Temperature Range | T_A | -40 to +100 | $^\circ\text{C}$ |
| Storage Temperature | T_{stg} | -40 to +100 | $^\circ\text{C}$ |
| Lead Soldering Temperature (Note 2) | — | 260 | $^\circ\text{C}$ |

ELECTRICAL CHARACTERISTICS ($T_A = 25^\circ\text{C}$ unless otherwise noted)

| Characteristic | Symbol | Min | Typ | Max | Unit |
|---|--------------|-----|------|-----|---------------|
| Reverse Leakage Current ($V_R = 6\text{ V}$) | I_R | — | 0.05 | 100 | μA |
| Forward Voltage ($I_F = 50\text{ mA}$) | V_F | — | 1.3 | 1.5 | V |
| Temperature Coefficient of Forward Voltage | ΔV_F | — | -1.6 | — | mV/K |
| Capacitance ($V = 0\text{ V}$, $f = 1\text{ MHz}$) | C | — | 18 | — | pF |

OPTICAL CHARACTERISTICS ($T_A = 25^\circ\text{C}$ unless otherwise noted)

| Characteristic | Symbol | Min | Typ | Max | Unit |
|--|----------------------|-----|----------|-----|---------------|
| Peak Wavelength ($I_F = 60\text{ mA}$) | λ_p | — | 940 | — | nm |
| Spectral Half-Power Bandwidth | $\Delta\lambda$ | — | 48 | — | nm |
| Continuous Power Output ($I_F = 50\text{ mA}$) (Note 3) | P_O | 2 | 2.5 | — | mW |
| Instantaneous Power Output ($I_F = 100\text{ mA}$) | P_O | — | 5 | — | mW |
| Instantaneous Axial Intensity ($I_F = 100\text{ mA}$) (Note 4) | I_o | — | 3.5 | — | mW/sr |
| Power Half-Angle | θ | — | ± 30 | — | $^\circ$ |
| Optical Turn-On and Turn-Off Times | t_{on} , t_{off} | — | 1 | — | μs |

- Notes: 1. Measured with device soldered into a typical printed circuit board.
 2. 5 seconds max; 1/16 inch from case. Heat sink should be applied during soldering, to prevent case temperature from exceeding 100°C .
 3. Measured using a Photodyne 88xLA with a #350 integrating sphere.
 4. On 0° axis, with cone angle of $\pm 13^\circ$.

MLED71

TYPICAL CHARACTERISTICS

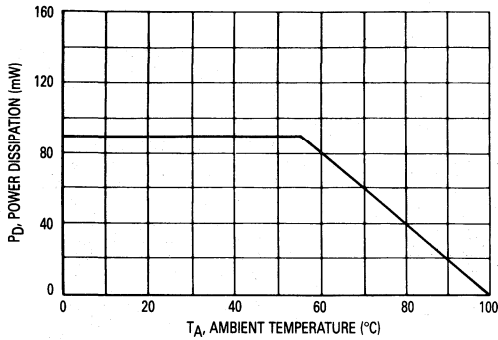

Figure 1. Power Dissipation

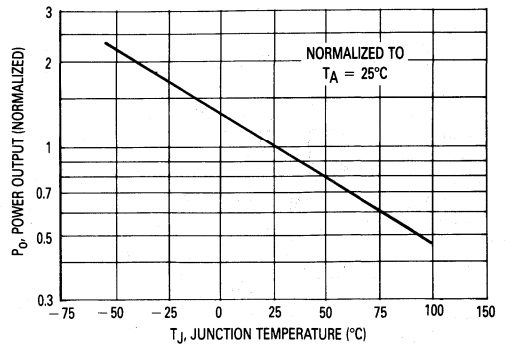

Figure 2. Instantaneous Power Output versus Ambient Temperature

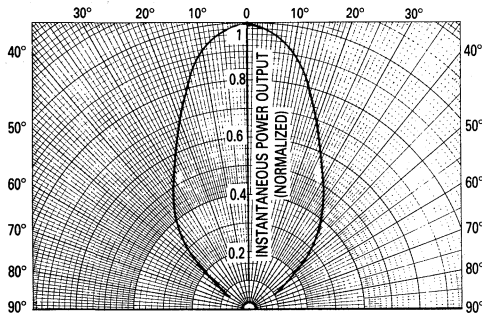

Figure 3. Spatial Radiation Pattern

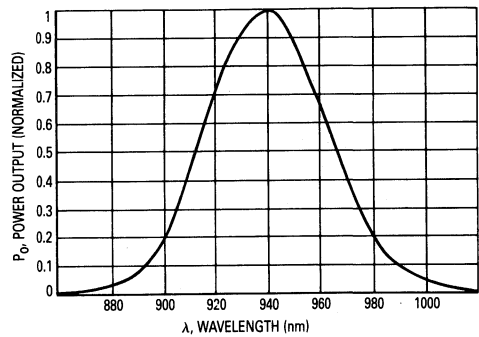

Figure 4. Relative Spectral Output

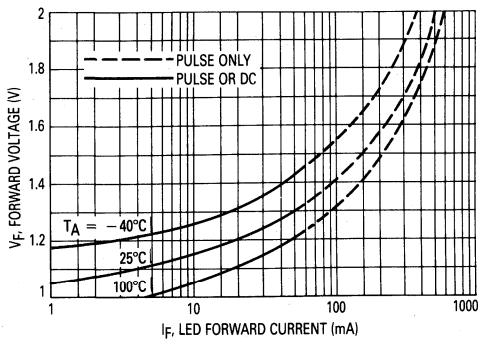

Figure 5. Forward Voltage versus Forward Current

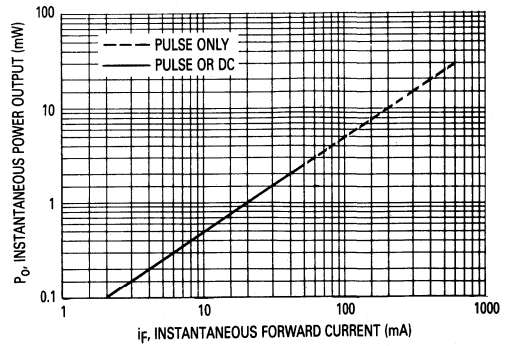

Figure 6. Instantaneous Power Output versus Forward Current

4

MLED71

OUTLINE DIMENSIONS

CASE 349-01 PLASTIC

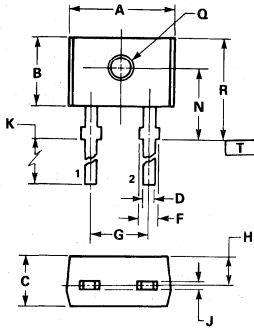

NOTES:

1. DIMENSIONS A, B AND C ARE DATUMS.
2. POSITIONAL TOLERANCE FOR D DIMENSION:
 $\pm 0.25 (0.010) \text{ (M) } \text{---T---} | \text{ A } \text{ (M) } | \text{ C } \text{ (M)}$
3. POSITIONAL TOLERANCE FOR Q DIAMETER:
 $\pm 0.25 (0.010) \text{ (M) } \text{---A---} | \text{ B } \text{ (M)}$
4. ---T--- IS SEATING PLANE.
5. DIMENSIONING AND TOLERANCING PER ANSI Y14.5, 1973.

STYLE 1:
PIN 1. CATHODE
2. ANODE

| DIM | MILLIMETERS | | INCHES | |
|-----|-------------|-------|-----------|-------|
| | MIN | MAX | MIN | MAX |
| A | 3.43 | 4.60 | 0.135 | 0.185 |
| B | 2.79 | 3.30 | 0.110 | 0.130 |
| C | 2.03 | 3.18 | 0.080 | 0.125 |
| D | 0.43 | 0.60 | 0.017 | 0.024 |
| F | 1.14 | 1.40 | 0.045 | 0.055 |
| G | 2.54 BSC | | 0.100 BSC | |
| H | 1.52 BSC | | 0.060 BSC | |
| J | 0.23 | 0.56 | 0.009 | 0.022 |
| K | 12.83 | 19.05 | 0.505 | 0.750 |
| N | 3.05 | 3.30 | 0.120 | 0.130 |
| Q | 0.76 | 1.52 | 0.030 | 0.060 |
| R | 3.81 | 4.60 | 0.150 | 0.185 |

Visible Red LED

This device is designed for a wide variety of applications where visible light emission is desirable, and can be used in conjunction with any MRD700 series detector. The MLED76 features high power output, using gallium aluminum arsenide technology.

- Low Cost
- Popular Case 349 Package
- Uses Stable Long-Life LED Technology
- Clear Epoxy Package

MLED76

**VISIBLE RED
LED
660 nm**

MAXIMUM RATINGS

| Rating | Symbol | Value | Unit |
|--|-----------|-------------|----------------------------|
| Reverse Voltage | V_R | 5 | Volts |
| Forward Current — Continuous | I_F | 60 | mA |
| Forward Current — Peak Pulse | I_F | 1 | A |
| Total Power Dissipation (at $T_A = 25^\circ\text{C}$ (Note 1) Derate above 35°C) | P_D | 132 2 | mW mW/ $^\circ\text{C}$ |
| Ambient Operating Temperature Range | T_A | -40 to +100 | $^\circ\text{C}$ |
| Storage Temperature | T_{stg} | -40 to +100 | $^\circ\text{C}$ |
| Lead Soldering Temperature (Note 2) | — | 260 | $^\circ\text{C}$ |

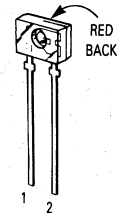

**CASE 349-01
PLASTIC**

4

ELECTRICAL CHARACTERISTICS ($T_A = 25^\circ\text{C}$ unless otherwise noted)

| Characteristic | Symbol | Min | Typ | Max | Unit |
|--|--------------|-----|------|-----|---------------|
| Reverse Leakage Current ($V_R = 3\text{ V}$) | I_R | — | 100 | — | nA |
| Reverse Leakage Current ($V_R = 5\text{ V}$) | I_R | — | 10 | 100 | μA |
| Forward Voltage ($I_F = 60\text{ mA}$) | V_F | — | 1.8 | 2.2 | V |
| Temperature Coefficient of Forward Voltage | ΔV_F | — | -2.2 | — | mV/K |
| Capacitance ($f = 1\text{ MHz}$) | C | — | 60 | — | pF |

OPTICAL CHARACTERISTICS ($T_A = 25^\circ\text{C}$ unless otherwise noted)

| | | | | | |
|--|-----------------|-----|----------|---|----------|
| Peak Wavelength ($I_F = 60\text{ mA}$) | λ_p | — | 660 | — | nm |
| Spectral Half-Power Bandwidth | $\Delta\lambda$ | — | 20 | — | nm |
| Continuous Power Output ($I_F = 60\text{ mA}$) (Note 3) | P_O | — | 2.2 | — | mW |
| Instantaneous Power Output ($I_F = 100\text{ mA}$) | P_O | — | 4 | — | mW |
| Instantaneous Axial Intensity ($I_F = 100\text{ mA}$) (Note 4) | I_o | 0.8 | 1.3 | — | mW/sr |
| Power Half-Angle | ϑ | — | ± 30 | — | $^\circ$ |
| Optical Turn-On Time | t_{on} | — | 200 | — | ns |
| Optical Turn-Off Time | t_{off} | — | 150 | — | ns |
| Half-Power Electrical Bandwidth (Note 5) | BWe | — | 6 | — | MHz |

- Notes: 1. Measured with device soldered into a typical printed circuit board.
2. 5 seconds max; 1/16 inch from case. Heat sink should be applied during soldering, to prevent case temperature from exceeding 100°C .
3. Measured using a Photodyne 88xLA with a #350 integrating sphere.
4. On-axis, with cone angle of $\pm 13^\circ$.
5. $I_F = 100\text{ mA}$ pk-pk, 100% modulation.

MLED76

TYPICAL CHARACTERISTICS

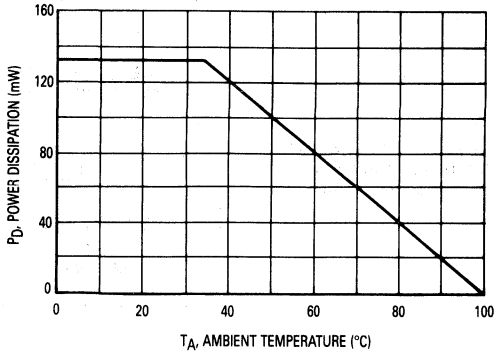

Figure 1. Power Dissipation

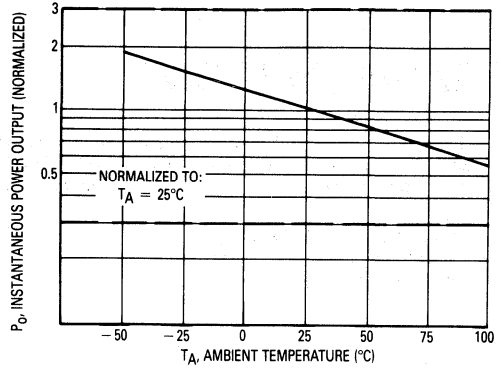

Figure 2. Instantaneous Power Output versus Ambient Temperature

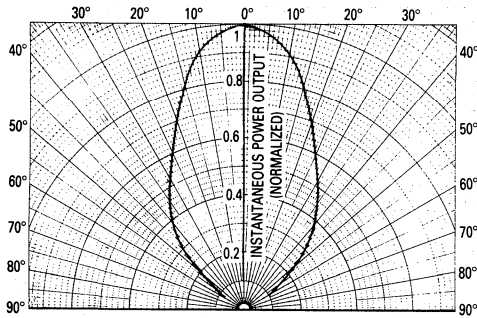

Figure 3. Spatial Radiation Pattern

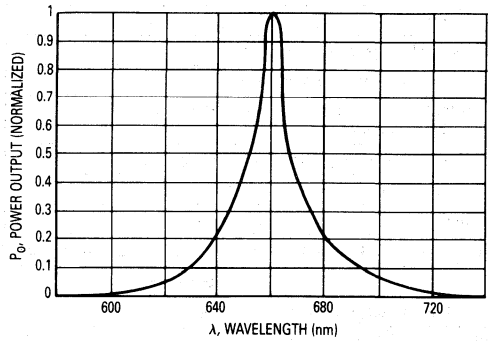

Figure 4. Relative Spectral Emission

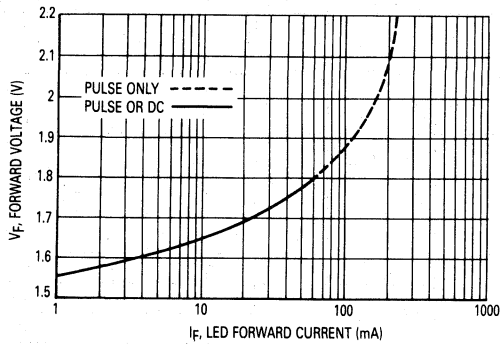

Figure 5. Forward Voltage versus Forward Current

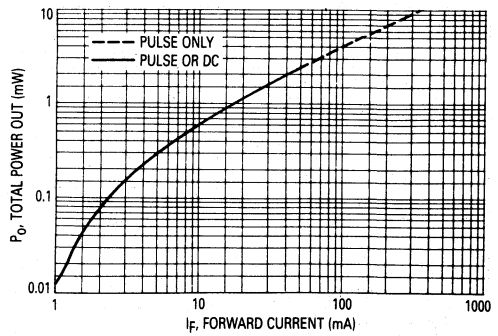
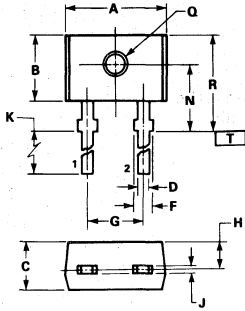

Figure 6. Instantaneous Power Output versus Forward Current

4

MLED76

OUTLINE DIMENSIONS



NOTES:

1. DIMENSIONS A, B AND C ARE DATUMS.
2. POSITIONAL TOLERANCE FOR D DIMENSION:
 $\pm 0.25 (0.010) \text{ } \textcircled{A} \text{ } \textcircled{C}$
3. POSITIONAL TOLERANCE FOR Q DIAMETER:
 $\pm 0.25 (0.010) \text{ } \textcircled{A} \text{ } \textcircled{B}$
4. \textcircled{T} IS SEATING PLANE.
5. DIMENSIONING AND TOLERANCING PER ANSI Y14.5, 1973.

STYLE 4:
 PIN 1. ANODE
 2. CATHODE

| DIM | MILLIMETERS | | INCHES | |
|-----|-------------|-------|-----------|-------|
| | MIN | MAX | MIN | MAX |
| A | 3.43 | 4.60 | 0.135 | 0.185 |
| B | 2.79 | 3.30 | 0.110 | 0.130 |
| C | 2.03 | 3.18 | 0.080 | 0.125 |
| D | 0.43 | 0.60 | 0.017 | 0.024 |
| F | 1.14 | 1.40 | 0.045 | 0.055 |
| G | 2.54 BSC | | 0.100 BSC | |
| H | 1.52 BSC | | 0.060 BSC | |
| J | 0.23 | 0.56 | 0.009 | 0.022 |
| K | 12.83 | 19.05 | 0.505 | 0.750 |
| N | 3.05 | 3.30 | 0.120 | 0.130 |
| Q | 0.76 | 1.52 | 0.030 | 0.060 |
| R | 3.81 | 4.60 | 0.150 | 0.185 |

CASE 349-01
PLASTIC

Infrared LED

This device is designed for a wide variety of infrared applications, including keyboards, end-of-tape sensors, coin or paper handlers, and other general sensing applications. The MLED77 can be used in conjunction with any MRD700 series detector. It features high power output, using gallium aluminum arsenide technology.

- Low Cost
- Popular Case 349 Package, with Molded Lens
- Uses Stable Long-Life LED Technology
- Clear Epoxy Package

MLED77

**INFRARED
LED
850 nm**

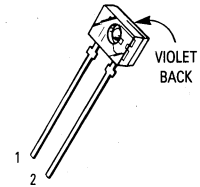

**CASE 349-01
PLASTIC**

MAXIMUM RATINGS

| Rating | Symbol | Value | Unit |
|--|-----------|-------------|----------------------------|
| Reverse Voltage | V_R | 6 | Volts |
| Forward Current — Continuous | I_F | 60 | mA |
| Forward Current — Peak Pulse | I_F | 1 | A |
| Total Power Dissipation @ $T_A = 25^\circ\text{C}$ (Note 1) Derate above 40°C | P_D | 120 2 | mW mW/ $^\circ\text{C}$ |
| Ambient Operating Temperature Range | T_A | -40 to +100 | $^\circ\text{C}$ |
| Storage Temperature | T_{stg} | -40 to +100 | $^\circ\text{C}$ |
| Lead Soldering Temperature (Note 2) | — | 260 | $^\circ\text{C}$ |

ELECTRICAL CHARACTERISTICS ($T_A = 25^\circ\text{C}$ unless otherwise noted)

| Characteristic | Symbol | Min | Typ | Max | Unit |
|---|--------------|-----|------|-----|---------------|
| Reverse Leakage Current ($V_R = 6\text{ V}$) | I_R | — | 0.05 | 100 | μA |
| Forward Voltage ($I_F = 50\text{ mA}$) | V_F | — | 1.4 | 2 | V |
| Temperature Coefficient of Forward Voltage | ΔV_F | — | -1.6 | — | mV/K |
| Capacitance ($V = 0\text{ V}$, $f = 1\text{ MHz}$) | C | — | 200 | — | pF |

OPTICAL CHARACTERISTICS ($T_A = 25^\circ\text{C}$ unless otherwise noted)

| Characteristic | Symbol | Min | Typ | Max | Unit |
|--|-----------------|-----|----------|-----|----------|
| Peak Wavelength ($I_F = 60\text{ mA}$) | λ_p | — | 850 | — | nm |
| Spectral Half-Power Bandwidth | $\Delta\lambda$ | — | 40 | — | nm |
| Instantaneous Power Output ($I_F = 100\text{ mA}$) | P_o | 1.7 | 2.5 | — | mW |
| Instantaneous Axial Intensity ($I_F = 100\text{ mA}$) (Note 3) | I_o | — | 3.5 | — | mW/sr |
| Power Half-Angle | θ | — | ± 30 | — | $^\circ$ |
| Optical Rise and Fall Time (10%–90%) (See Figure 7) | t_r, t_f | — | 25 | 35 | ns |

- Notes: 1. Measured with device soldered into a typical printed circuit board.
 2. 5 seconds max; 1/16 inch from case. Heat sink should be applied during soldering, to prevent case temperature from exceeding 100°C .
 3. On 0° axis, with cone angle of $\pm 13^\circ$.

MLED77

TYPICAL CHARACTERISTICS

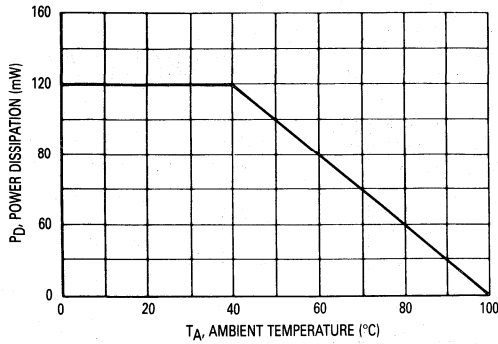

Figure 1. Power Dissipation

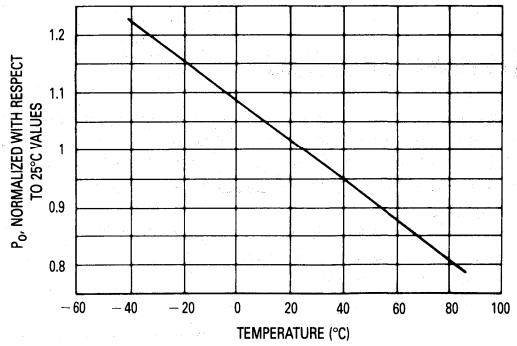

Figure 2. Instantaneous Power Output Ambient Temperature

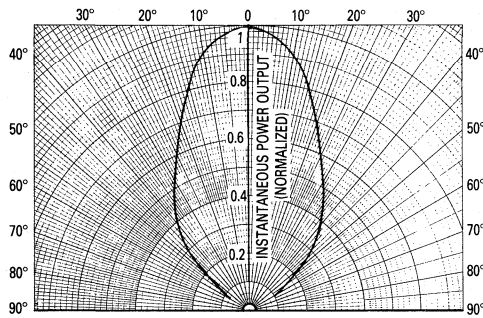

Figure 3. Spatial Radiation Pattern

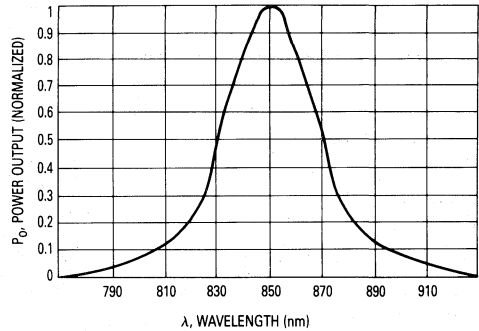

Figure 4. Relative Spectral Output

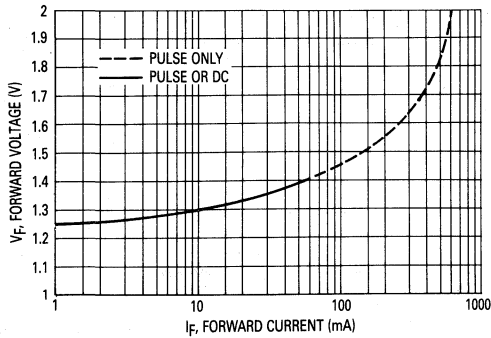

Figure 5. Forward Voltage versus Forward Current

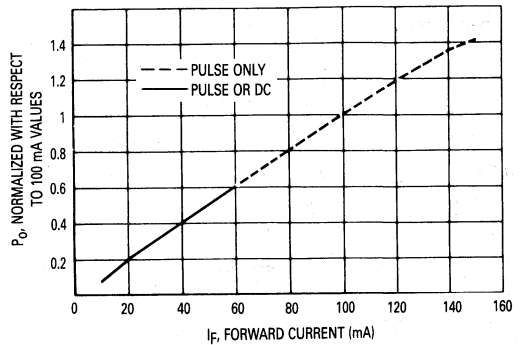

Figure 6. Instantaneous Power Output versus Forward Current

4

MLED77

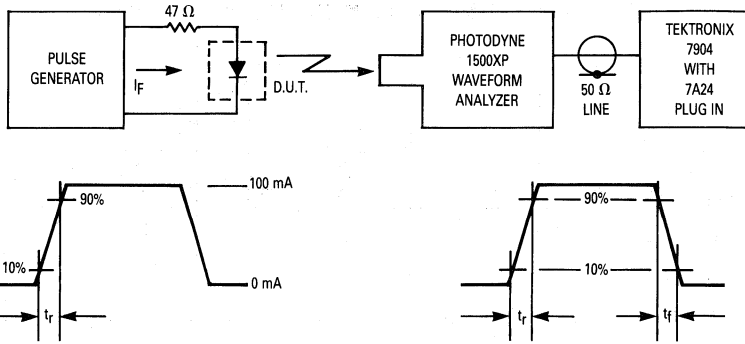
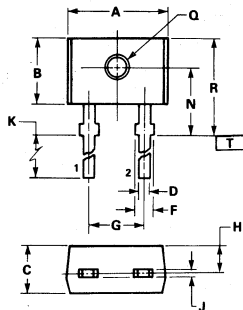

Figure 7. Rise and Fall Time Measurement Circuit

OUTLINE DIMENSIONS



NOTES:

1. DIMENSIONS A, B AND C ARE DATUMS.
2. POSITIONAL TOLERANCE FOR D DIMENSION:
 $\pm 0.25 (0.010) \text{ (M)} \text{ [-T] A } \text{ (M)} \text{ [C] } \text{ (M)}$
3. POSITIONAL TOLERANCE FOR Q DIAMETER:
 $\pm 0.25 (0.010) \text{ (M)} \text{ [A] } \text{ (M)} \text{ [B] } \text{ (M)}$
4. [-T] IS SEATING PLANE.
5. DIMENSIONING AND TOLERANCING PER ANSI Y14.5, 1973.

STYLE 4:
 PIN 1. ANODE
 2. CATHODE

| DIM | MILLIMETERS | | INCHES | |
|-----|-------------|-------|-----------|-------|
| | MIN | MAX | MIN | MAX |
| A | 3.43 | 4.60 | 0.135 | 0.185 |
| B | 2.79 | 3.30 | 0.110 | 0.130 |
| C | 2.03 | 3.18 | 0.080 | 0.125 |
| D | 0.43 | 0.60 | 0.017 | 0.024 |
| F | 1.14 | 1.40 | 0.045 | 0.055 |
| G | 2.54 BSC | | 0.100 BSC | |
| H | 1.52 BSC | | 0.060 BSC | |
| J | 0.23 | 0.56 | 0.009 | 0.022 |
| K | 12.83 | 19.05 | 0.505 | 0.750 |
| N | 3.05 | 3.30 | 0.120 | 0.130 |
| Q | 0.76 | 1.52 | 0.030 | 0.060 |
| R | 3.81 | 4.60 | 0.150 | 0.185 |

CASE 349-01
 PLASTIC

Infrared LED

This device is designed for infrared remote control and other sensing applications, and can be used in conjunction with the MRD821 photodiode. It features high power output, using long-life gallium arsenide technology.

- Low Cost
- Popular T-1 $\frac{1}{4}$ Package
- Ideal Beam Angle for Most Remote Control Applications
- Uses Stable Long-Life LED Technology
- Clear Epoxy Package

MAXIMUM RATINGS

| Rating | Symbol | Value | Unit |
|--|-----------|------------|----------------------------|
| Reverse Voltage | V_R | 5 | Volts |
| Forward Current — Continuous | I_F | 100 | mA |
| Forward Current — Peak Pulse | I_F | 1 | A |
| Total Power Dissipation (@ $T_A = 25^\circ\text{C}$ Derate above 25°C) | P_D | 100 2.2 | mW mW/ $^\circ\text{C}$ |
| Ambient Operating Temperature Range | T_A | -30 to +70 | $^\circ\text{C}$ |
| Storage Temperature | T_{stg} | -30 to +80 | $^\circ\text{C}$ |
| Lead Soldering Temperature, 5 seconds max, 1/16 inch from case | — | 260 | $^\circ\text{C}$ |

ELECTRICAL CHARACTERISTICS ($T_A = 25^\circ\text{C}$ unless otherwise noted)

| Characteristic | Symbol | Min | Typ | Max | Unit |
|--|--------------|-----|------|-----|---------------|
| Reverse Leakage Current ($V_R = 3\text{ V}$) | I_R | — | 10 | — | nA |
| Reverse Leakage Current ($V_R = 5\text{ V}$) | I_R | — | 1 | 10 | μA |
| Forward Voltage ($I_F = 100\text{ mA}$) | V_F | — | 1.35 | 1.7 | V |
| Temperature Coefficient of Forward Voltage | ΔV_F | — | -1.6 | — | mV/K |
| Capacitance ($f = 1\text{ MHz}$) | C | — | 25 | — | pF |

OPTICAL CHARACTERISTICS ($T_A = 25^\circ\text{C}$ unless otherwise noted)

| Characteristic | Symbol | Min | Typ | Max | Unit |
|--|-----------------|-----|----------|-----|----------|
| Peak Wavelength ($I_F = 100\text{ mA}$) | λ_p | — | 940 | — | nm |
| Spectral Half-Power Bandwidth | $\Delta\lambda$ | — | 50 | — | nm |
| Total Power Output ($I_F = 100\text{ mA}$) | ϕ_e | — | 16 | — | mW |
| Temperature Coefficient of Total Power Output | $\Delta\phi_e$ | — | -0.25 | — | %/K |
| Axial Radiant Intensity ($I_F = 100\text{ mA}$) | I_e | 10 | 15 | — | mW/sr |
| Temperature Coefficient of Axial Radiant Intensity | ΔI_e | — | -0.25 | — | %/K |
| Power Half-Angle | φ | — | ± 30 | — | $^\circ$ |

MLED81

**INFRARED
LED
940 nm**



CASE 279B-01

MLED81

TYPICAL CHARACTERISTICS

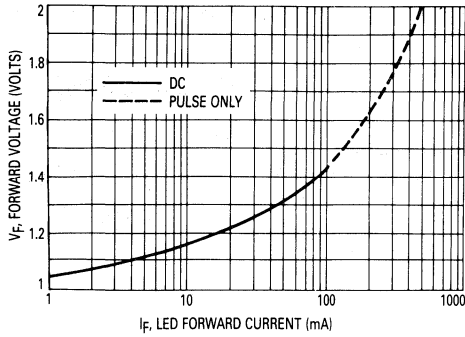

Figure 1. LED Forward Voltage versus Forward Current

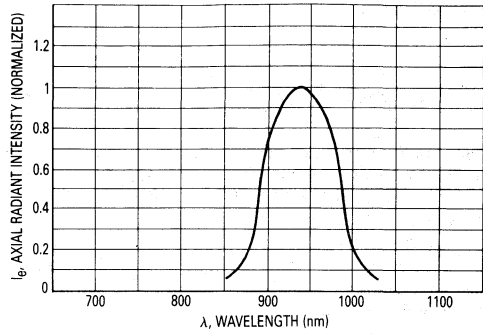

Figure 2. Relative Spectral Emission

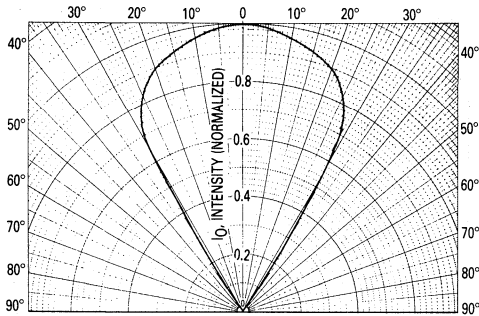

Figure 3. Spatial Radiation Pattern

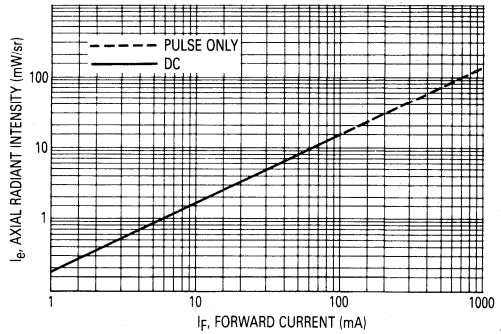

Figure 4. Intensity versus Forward Current

OUTLINE DIMENSIONS

CASE 279B-01

- NOTES:
1. DIMENSIONING AND TOLERANCING PER ANSI Y14.5M, 1982.
 2. CONTROLLING DIMENSION: INCH.

| DIM | MILLIMETERS | | INCHES | |
|-----|-------------|-------|--------|-------|
| | MIN | MAX | MIN | MAX |
| A | 5.52 | 5.96 | 0.217 | 0.235 |
| B | 4.80 | 5.20 | 0.189 | 0.205 |
| C | 8.13 | 9.14 | 0.320 | 0.360 |
| D | 0.51 | 0.71 | 0.020 | 0.028 |
| E | 1.15 | 1.39 | 0.045 | 0.055 |
| F | 0.51 | 0.76 | 0.020 | 0.030 |
| G | 2.29 | 2.79 | 0.090 | 0.110 |
| K | 25.40 | 26.67 | 1.00 | 1.05 |
| L | 0.18 | 1.82 | 0.007 | 0.072 |
| R | 2.42 | 2.79 | 0.095 | 0.110 |

STYLE 1:
PIN 1. CATHODE
2. ANODE

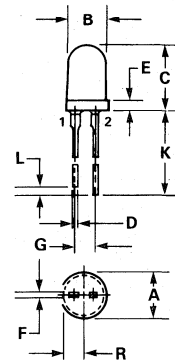

Infrared LED

... designed for applications requiring high power output, low drive power and very fast response time. This device is used in industrial processing and control, light modulators, shaft or position encoders, punched card readers, optical switching, and logic circuits. It is spectrally matched for use with silicon detectors.

- High-Power Output — 4 mW (Typ) @ $I_F = 100$ mA, Pulsed
- Infrared-Emission — 940 nm (Typ)
- Low Drive Current — 10 mA for 450 μ W (Typ)
- Popular TO-18 Type Package for Easy Handling and Mounting
- Hermetic Metal Package for Stability and Reliability

MLED930

**INFRARED
LED
940 nm**

CONVEX
LENS



**CASE 209-01
METAL**

4

MAXIMUM RATINGS

| Rating | Symbol | Value | Unit |
|---|-----------|-------------|----------------------------|
| Reverse Voltage | V_R | 6 | Volts |
| Forward Current — Continuous | I_F | 60 | mA |
| Forward Current — Peak Pulse (PW = 100 μ s, d.c. = 2%) | I_F | 1 | A |
| Total Device Dissipation @ $T_A = 25^\circ\text{C}$ Derate above 25°C (Note 1) | P_D | 250 2.27 | mW mW/ $^\circ\text{C}$ |
| Operating Temperature Range | T_A | -55 to +125 | $^\circ\text{C}$ |
| Storage Temperature Range | T_{stg} | -65 to +150 | $^\circ\text{C}$ |

ELECTRICAL CHARACTERISTICS ($T_A = 25^\circ\text{C}$ unless otherwise noted)

| Characteristic | Fig. No. | Symbol | Min | Typ | Max | Unit |
|--|----------|----------|-----|------|-----|-------|
| Reverse Leakage Current ($V_R = 3$ V) | — | I_R | — | 2 | — | nA |
| Reverse Breakdown Voltage ($I_R = 100$ μ A) | — | $V(BR)R$ | 6 | 20 | — | Volts |
| Forward Voltage ($I_F = 50$ mA) | 2 | V_F | — | 1.32 | 1.5 | Volts |
| Total Capacitance ($V_R = 0$ V, $f = 1$ MHz) | — | C_T | — | 18 | — | pF |

OPTICAL CHARACTERISTICS ($T_A = 25^\circ\text{C}$ unless otherwise noted)

| | | | | | | |
|--|------|-----------------|--------|----------|---|------------------|
| Total Power Output (Note 2) ($I_F = 60$ mA, dc) ($I_F = 100$ mA, PW = 100 μ s, duty cycle = 2%) | 3, 4 | P_O | — 1 | 2.5 4 | — | mW |
| Radiant Intensity (Note 3) ($I_F = 100$ mA, PW = 100 μ s, duty cycle = 2%) | — | I_o | — | 1.5 | — | mW/ steradian |
| Peak Emission Wavelength | 1 | λ_P | — | 940 | — | nm |
| Spectral Line Half Width | 1 | $\Delta\lambda$ | — | 40 | — | nm |

Notes: 1. Printed Circuit Board Mounting

2. Power Output, P_O , is the total power radiated by the device into a solid angle of 2π steradians. It is measured by directing all radiation leaving the device, within this solid angle, onto a calibrated silicon solar cell.

3. Irradiance from a Light Emitting Diode (LED) can be calculated by:
 I_o where H is irradiance in mW/cm²; I_o is radiant intensity in mW/steradian;

$$H = \frac{I_o}{d^2}$$

d^2 is distance from LED to the detector in cm.

MLED930

TYPICAL CHARACTERISTICS

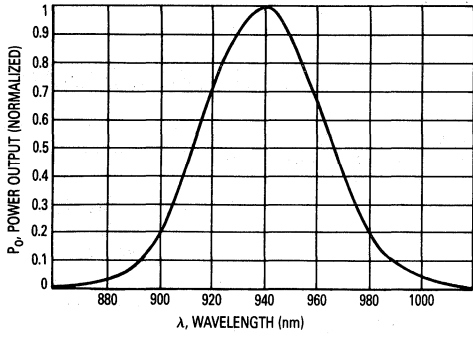

Figure 1. Relative Spectral Output

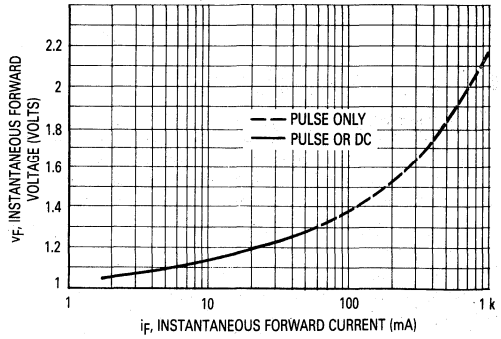

Figure 2. Forward Characteristics

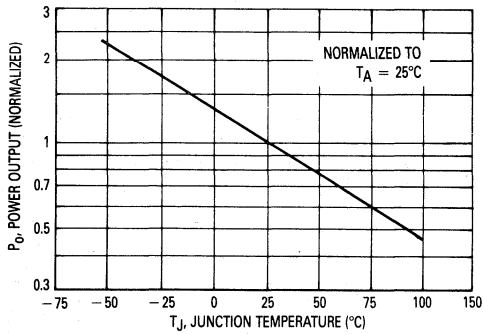

Figure 3. Power Output versus Junction Temperature

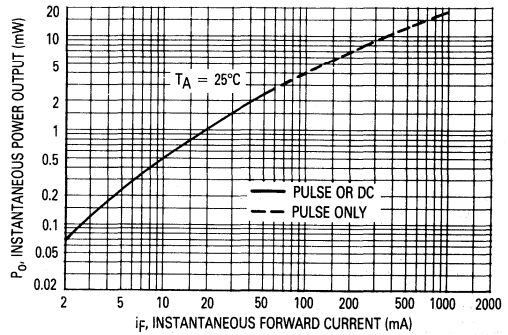

Figure 4. Instantaneous Power Output versus Forward Current

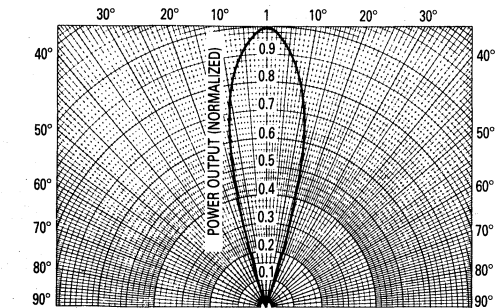

Figure 5. Spatial Radiation Pattern

OUTLINE DIMENSIONS

- NOTES:
 1. PIN 2 INTERNALLY CONNECTED TO CASE
 2. LEADS WITHIN 0.13 mm (0.005) RADIUS OF TRUE POSITION AT SEATING PLANE AT MAXIMUM MATERIAL CONDITION.

| DIM | MILLIMETERS | | INCHES | |
|-----|-------------|------|-----------|-------|
| | MIN | MAX | MIN | MAX |
| A | 5.31 | 5.84 | 0.209 | 0.230 |
| B | 4.52 | 4.95 | 0.178 | 0.195 |
| C | 5.08 | 6.35 | 0.200 | 0.250 |
| D | 0.41 | 0.48 | 0.016 | 0.019 |
| F | 0.51 | 1.02 | 0.020 | 0.040 |
| G | 2.54 BSC | | 0.100 BSC | |
| H | 0.99 | 1.17 | 0.039 | 0.046 |
| J | 0.84 | 1.22 | 0.033 | 0.048 |
| K | 12.70 | — | 0.500 | — |
| L | 3.35 | 4.01 | 0.132 | 0.158 |
| M | 45° BSC | | 45° BSC | |

STYLE 1:
 PIN 1, ANODE
 2, CATHODE

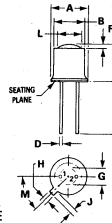

CASE 209-01
 METAL

Photo Detector Transistor Output

... designed for application in punched card and tape readers, pattern and character recognition equipment, shaft encoders, industrial inspection processing and control, counters, sorters, switching and logic circuits, or any design requiring radiation sensitivity, stable characteristics and high-density mounting.

- Economical Plastic Package
- Sensitive Throughout Visible and Near Infrared Spectral Range for Wide Application
- Small Size for High-Density Mounting
- High Light Current Sensitivity (0.2 mA) for Design Flexibility
- Annular Passivated Structure for Stability and Reliability

MRD150

**PHOTO DETECTOR
 TRANSISTOR OUTPUT
 NPN SILICON
 50 MILLIWATTS
 40 VOLTS**

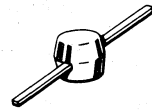

CASE 173-01
 PLASTIC

MAXIMUM RATINGS ($T_A = 25^\circ\text{C}$ unless otherwise noted)

| Rating | Symbol | Value | Unit |
|---|----------------|-------------|----------------------------|
| Collector-Emitter Voltage | V_{CEO} | 40 | Volts |
| Emitter-Collector Voltage | V_{ECO} | 6 | Volts |
| Total Device Dissipation @ $T_A = 25^\circ\text{C}$ Note 1 Derate above 25°C | P_D | 100 1.33 | mW mW/ $^\circ\text{C}$ |
| Operating and Storage Junction Temperature Range | T_J, T_{stg} | -40 to +100 | $^\circ\text{C}$ |
| Lead Soldering Temperature (5 sec. max) Note 2 | — | 260 | $^\circ\text{C}$ |

STATIC ELECTRICAL CHARACTERISTICS ($T_A = 25^\circ\text{C}$ unless otherwise noted)

| Characteristic | Fig. No. | Symbol | Min | Typ | Max | Unit |
|---|----------|---------------|--------|--------|----------|---------------|
| Collector Dark Current ($V_{CC} = 20\text{ V}$; Base Open) Note 3 | — | I_{CEO} | — — | — 5 | 0.1 — | μA |
| Collector-Emitter Breakdown Voltage ($I_C = 100\ \mu\text{A}$; Base Open) Note 3 | — | $V_{(BR)CEO}$ | 40 | — | — | Volts |
| Emitter-Collector Breakdown Voltage ($I_E = 100\ \mu\text{A}$; Base Open) Note 3 | — | $V_{(BR)ECO}$ | 6 | — | — | Volts |

OPTICAL CHARACTERISTICS ($T_A = 25^\circ\text{C}$ unless otherwise noted)

| Characteristic | Fig. No. | Symbol | Min | Typ | Max | Unit |
|--|----------|-------------|-----|------|-----|---------------|
| Collector Light Current ($V_{CC} = 20\text{ V}$; $R_L = 100\ \text{Ohms}$; Base Open) Note 4 | 1 | I_L | 0.2 | 0.45 | — | mA |
| Photo Current Rise Time, Note 5 | 8 | t_r | — | 2.5 | — | μs |
| Photo Current Fall Time, Note 5 | 8 | t_f | — | 4 | — | μs |
| Wavelength of Maximum Sensitivity | 7 | λ_s | — | 0.8 | — | μm |

- NOTES: 1. Printed circuit board mounting.
 2. Heat Sink should be applied to leads during soldering to prevent Case Temperature from exceeding 100°C .
 3. Measured under dark conditions. ($H \approx 0$).
 4. Radiation Flux Density (H) equal to $5\ \text{mW/cm}^2$ emitted from a tungsten source at a color temperature of $2870\ \text{K}$.
 5. For unsaturated response time measurements, radiation is provided by pulsed GaAs (gallium-arsenide) light-emitting diode ($\lambda \approx 940\ \text{nm}$) with a pulse width equal to or greater than 500 microseconds (see Figure 8).

TYPICAL CHARACTERISTICS

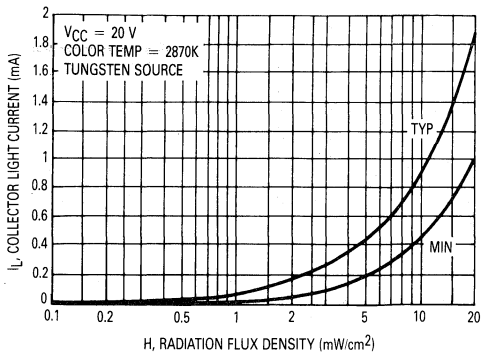

Figure 1. Collector-Emitter Sensitivity

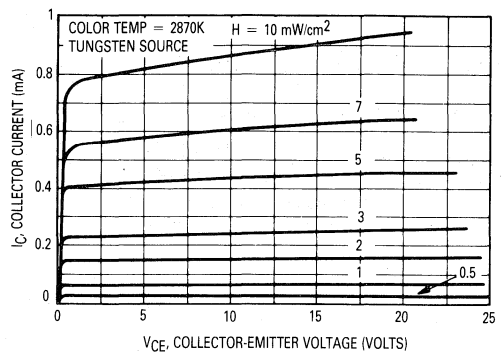

Figure 2. Collector-Emitter Characteristics

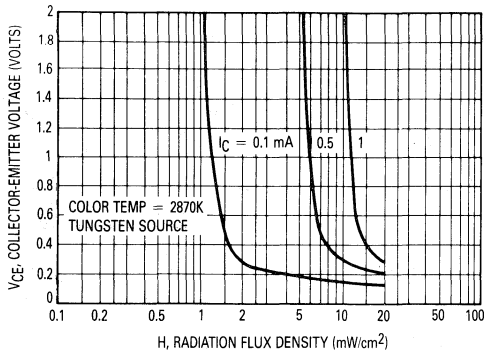

Figure 3. Collector Saturation Characteristics

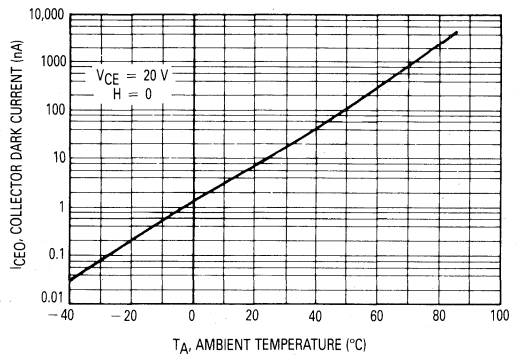

Figure 4. Dark Current versus Temperature

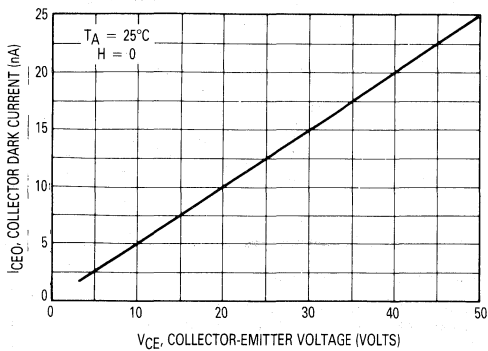

Figure 5. Dark Current versus Voltage

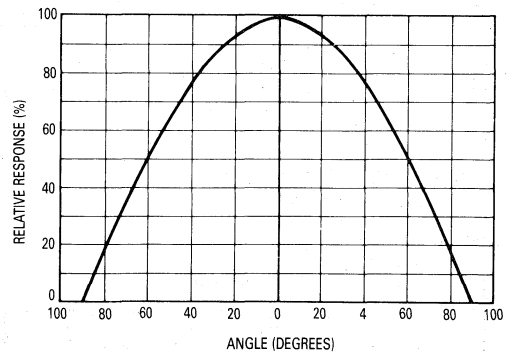

Figure 6. Angular Response

MRD150

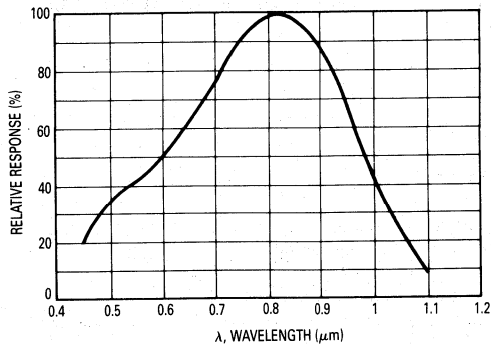

Figure 7. Constant Energy Spectral Response

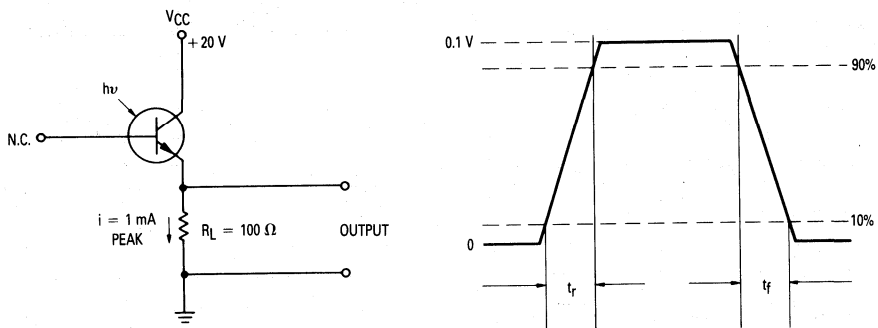
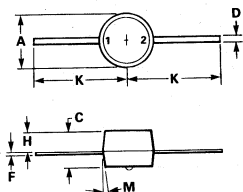

Figure 8. Pulse Response Test Circuit and Waveform

OUTLINE DIMENSIONS



NOTE:
1. INDEX BUTTON ON PACKAGE BOTTOM IS 0.25/
0.51 mm (0.010/0.020) DIA & 0.05/0.13 mm (0.002/
0.005) OFF SURFACE.

STYLE 1:
PIN 1. EMITTER
2. COLLECTOR

| DIM | MILLIMETERS | | INCHES | |
|-----|-------------|------|--------|-------|
| | MIN | MAX | MIN | MAX |
| A | 1.98 | 2.34 | 0.078 | 0.092 |
| C | 1.22 | 1.47 | 0.048 | 0.058 |
| D | 0.25 | 0.41 | 0.010 | 0.016 |
| F | 0.10 | 0.15 | 0.004 | 0.006 |
| H | 0.51 | 0.76 | 0.020 | 0.030 |
| K | 4.06 | — | 0.160 | — |
| M | 3° | 7° | 3° | 7° |

CASE 173-01
PLASTIC

4

Photo Detectors Transistor Output

... designed for application in industrial inspection, processing and control, counters, sorters, switching and logic circuits or any design requiring radiation sensitivity, and stable characteristics.

- Popular TO-18 Type Package for Easy Handling and Mounting
- Sensitive Throughout Visible and Near Infrared Spectral Range for Wider Application
- Minimum Light Current 4 mA at $H = 5 \text{ mW/cm}^2$ (MRD300)
- External Base for Added Control
- Annular Passivated Structure for Stability and Reliability

MRD300
MRD310

PHOTO DETECTORS
TRANSISTOR OUTPUT
NPN SILICON



CASE 82-05
METAL

MAXIMUM RATINGS ($T_A = 25^\circ\text{C}$ unless otherwise noted)

| Rating | Symbol | Value | Unit |
|--|-----------|-------------|-------------|
| Collector-Emitter Voltage | V_{CEO} | 50 | Volts |
| Emitter-Collector Voltage | V_{ECO} | 7 | Volts |
| Collector-Base Voltage | V_{CBO} | 80 | Volts |
| Total Device Dissipation @ $T_A = 25^\circ\text{C}$ Derate above 25°C | PD | 250 2.27 | mW mW/°C |
| Operating Temperature Range | T_A | -55 to +125 | °C |
| Storage Temperature Range | T_{stg} | -65 to +150 | °C |

STATIC ELECTRICAL CHARACTERISTICS ($T_A = 25^\circ\text{C}$ unless otherwise noted)

| Characteristic | Symbol | Min | Typ | Max | Unit |
|--|---------------|-----|--------|---------|---------------------|
| Collector Dark Current ($V_{CE} = 20 \text{ V}$, $H \approx 0$) $T_A = 25^\circ\text{C}$ $T_A = 100^\circ\text{C}$ | I_{CEO} | — | 5 4 | 25 — | nA μA |
| Collector-Base Breakdown Voltage ($I_C = 100 \mu\text{A}$) | $V_{(BR)CBO}$ | 80 | 120 | — | Volts |
| Collector-Emitter Breakdown Voltage ($I_C = 100 \mu\text{A}$) | $V_{(BR)CEO}$ | 50 | 85 | — | Volts |
| Emitter-Collector Breakdown Voltage ($I_E = 100 \mu\text{A}$) | $V_{(BR)ECO}$ | 7 | 8.5 | — | Volts |

OPTICAL CHARACTERISTICS ($T_A = 25^\circ\text{C}$ unless otherwise noted)

| | | | | | | |
|--|------------------|-------|--------|------------|--------|---------------|
| Light Current ($V_{CC} = 20 \text{ V}$, $R_L = 10 \text{ Ohms}$) Note 1 | MRD300 MRD310 | I_L | 4 1 | 7 3.5 | — — | mA |
| Light Current ($V_{CC} = 20 \text{ V}$, $R_L = 100 \text{ Ohms}$) Note 2 | MRD300 MRD310 | I_L | — — | 2.5 0.8 | — — | mA |
| Photo Current Rise Time (Note 3) ($R_L = 100 \text{ Ohms}$, $I_L = 1 \text{ mA peak}$) | | t_r | — | 2 | 2.5 | μs |
| Photo Current Fall Time (Note 3) ($R_L = 100 \text{ Ohms}$, $I_L = 1 \text{ mA peak}$) | | t_f | — | 2.5 | 4 | μs |

- NOTES: 1. Radiation flux density (H) equal to 5 mW/cm^2 emitted from a tungsten source at a color temperature of 2870 K.
 2. Radiation flux density (H) equal to 0.5 mW/cm^2 (pulsed) from a GaAs (gallium-arsenide) source at $\lambda = 940 \text{ nm}$.
 3. For unsaturated response time measurements, radiation is provided by pulsed GaAs (gallium-arsenide) light-emitting diode ($\lambda = 940 \text{ nm}$) with a pulse width equal to or greater than 10 microseconds (see Figure 2) $I_L = 1 \text{ mA peak}$.

MRD300, MRD310

TYPICAL CHARACTERISTICS

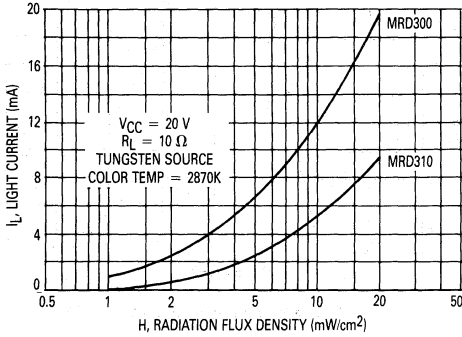

Figure 1. Light Current versus Irradiance

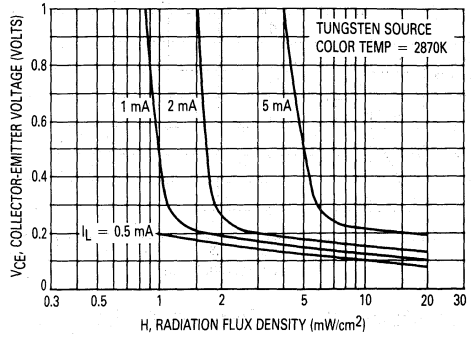

Figure 2. Collector-Emitter Saturation Characteristic

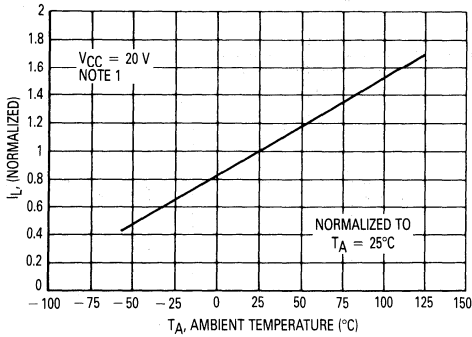

Figure 3. Normalized Light Current versus Temperature

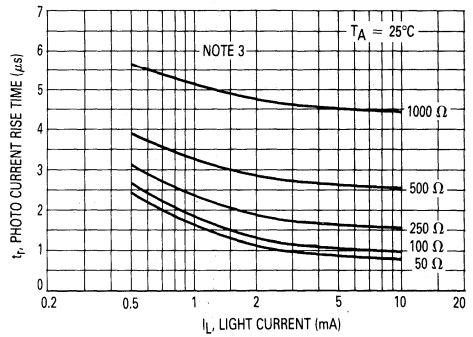

Figure 4. Rise Time versus Light Current

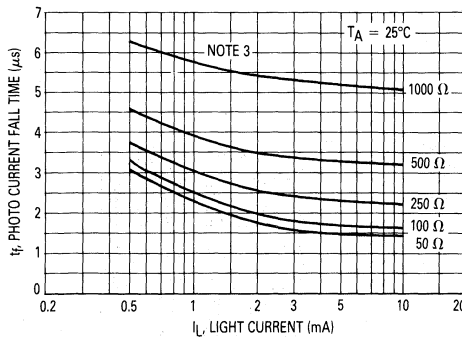

Figure 5. Fall Time versus Light Current

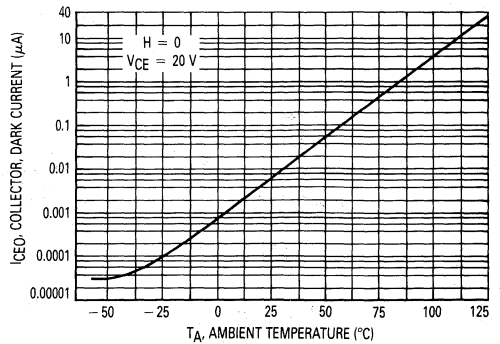

Figure 6. Dark Current versus Temperature

4

MRD300, MRD310

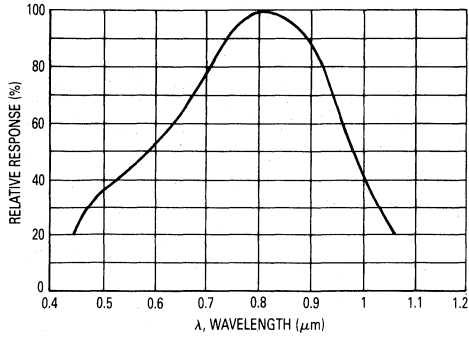

Figure 7. Constant Energy Spectral Response

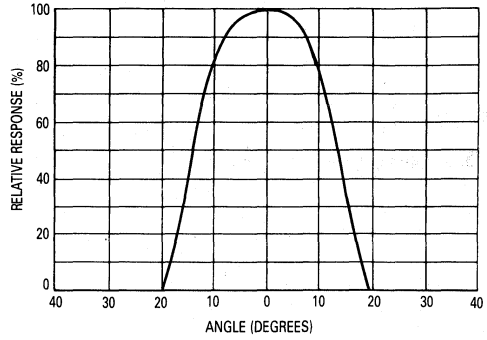

Figure 8. Angular Response

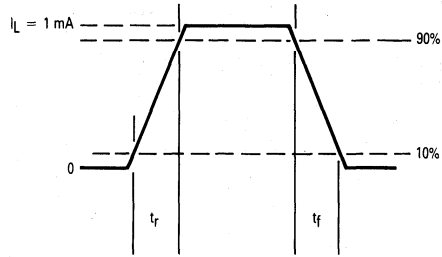
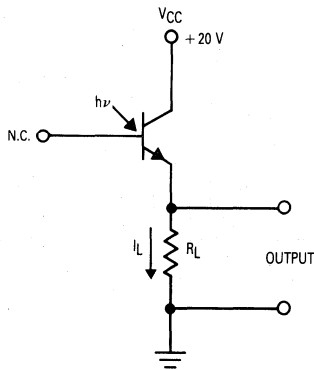
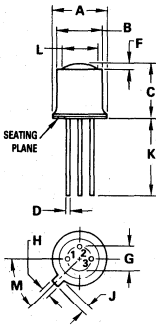

Figure 9. Pulse Response Test Circuit and Waveform

4

OUTLINE DIMENSIONS



NOTES:

- LEADS WITHIN .13 mm (.005) RADIUS OF TRUE POSITION AT SEATING PLANE, AT MAXIMUM MATERIAL CONDITION.
- PIN 3 INTERNALLY CONNECTED TO CASE.

- STYLE 1:
 PIN 1. EMITTER
 2. BASE
 3. COLLECTOR

| DIM | MILLIMETERS | | INCHES | |
|-----|-------------|------|-----------|-------|
| | MIN | MAX | MIN | MAX |
| A | 5.31 | 5.84 | 0.209 | 0.230 |
| B | 4.52 | 4.95 | 0.178 | 0.195 |
| C | 4.57 | 6.48 | 0.180 | 0.255 |
| D | 0.41 | 0.48 | 0.016 | 0.019 |
| F | — | 1.14 | — | 0.045 |
| G | 2.54 BSC | | 0.100 BSC | |
| H | 0.99 | 1.17 | 0.039 | 0.046 |
| J | 0.84 | 1.22 | 0.033 | 0.048 |
| K | 12.70 | — | 0.500 | — |
| L | 3.35 | 4.01 | 0.132 | 0.158 |
| M | 45° BSC | | 45° BSC | |

CASE 82-05
 METAL

Photo Detectors Darlington Output

... designed for application in industrial inspection, processing and control, counters, sorters, switching and logic circuit or any design requiring very high radiation sensitivity at low light levels.

- Popular TO-18 Type Hermetic Package for Easy Handling and Mounting
- Sensitive Throughout Visible and Near Infrared Spectral Range for Wider Application
- Minimum Light Current 12 mA at H = 0.5 mW/cm² (MRD360)
- External Base for Added Control
- Switching Times —
 - $t_r @ I_L = 1 \text{ mA peak} = 15 \mu\text{s (Typ)} - \text{MRD370}$
 - $t_f @ I_L = 1 \text{ mA peak} = 25 \mu\text{s (Typ)} - \text{MRD370}$

MRD360
MRD370

PHOTO DETECTORS
DARLINGTON OUTPUT
NPN SILICON

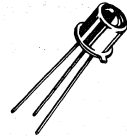

CASE 82-05
METAL

MAXIMUM RATINGS (T_A = 25°C unless otherwise noted)

| Rating | Symbol | Value | Unit |
|---|------------------|-------------|-------------|
| Collector-Emitter Voltage | V _{CEO} | 40 | Volts |
| Emitter-Base Voltage | V _{EBO} | 10 | Volts |
| Collector-Base Voltage | V _{CB0} | 50 | Volts |
| Light Current | I _L | 250 | mA |
| Total Device Dissipation @ T _A = 25°C Derate above 25°C | P _D | 250 2.27 | mW mW/°C |
| Operating Temperature Range | T _A | -55 to +125 | °C |
| Storage Temperature Range | T _{stg} | -65 to +150 | °C |

STATIC ELECTRICAL CHARACTERISTICS (T_A = 25°C unless otherwise noted)

| Characteristic | Symbol | Min | Typ | Max | Unit |
|--|----------------------|-----|-----|-----|-------|
| Collector Dark Current (V _{CE} = 10 V, H ≈ 0) T _A = 25°C | I _{CEO} | — | 10 | 100 | nA |
| Collector-Base Breakdown Voltage (I _C = 100 μA) | V _{(BR)CB0} | 50 | — | — | Volts |
| Collector-Emitter Breakdown Voltage (I _C = 100 μA) | V _{(BR)CEO} | 40 | — | — | Volts |
| Emitter-Base Breakdown Voltage (I _E = 100 μA) | V _{(BR)EBO} | 10 | — | — | Volts |

OPTICAL CHARACTERISTICS (T_A = 25°C unless otherwise noted)

| Characteristic | MRD360 MRD370 | Symbol | Min | Typ | Max | Unit |
|---|------------------|----------------------|---------|----------|------------|------|
| Light Current (V _{CC} = 5 V, R _L = 10 Ohms) Note 1 | | I _L | 12 3 | 20 10 | — | mA |
| Collector-Emitter Saturation Voltage (I _L = 10 mA, H = 2 mW/cm ² at 2870K) | | V _{CE(sat)} | — | — | 1 | Volt |
| Photo Current Rise Time (Note 2) (R _L = 100 ohms, I _L = 1 mA peak) | MRD360 MRD370 | t _r | — | 40 15 | 100 100 | μs |
| Photo Current Fall Time (Note 2) (R _L = 100 ohms, I _L = 1 mA peak) | MRD360 MRD370 | t _f | — | 60 25 | 150 150 | μs |
| Wavelength of Maximum Sensitivity | | λ _s | — | 0.8 | — | μm |

NOTES: 1. Radiation flux density (H) equal to 0.5 mW/cm² emitted from a tungsten source at a color temperature of 2870 K.

2. For unsaturated response time measurements, radiation is provided by pulsed GaAs (gallium-arsenide) light-emitting diode (λ ≈ 940 nm) with a pulse width equal to or greater than 500 microseconds (see Figure 6) I_L = 1 mA peak.

MRD360, MRD370

TYPICAL CHARACTERISTICS

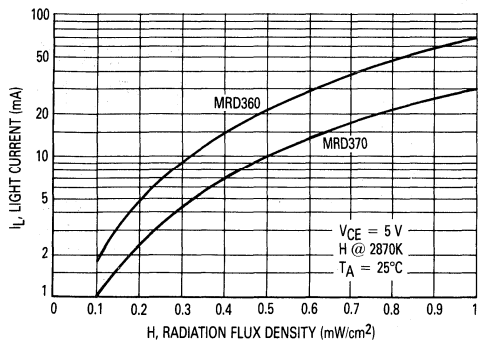

Figure 1. Light Current versus Irradiance

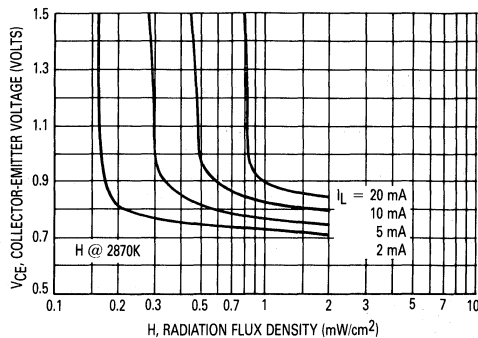

Figure 2. Collector-Emitter Saturation Characteristic

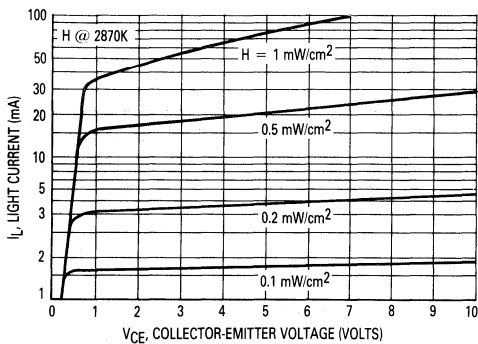

Figure 3. Collector Characteristics

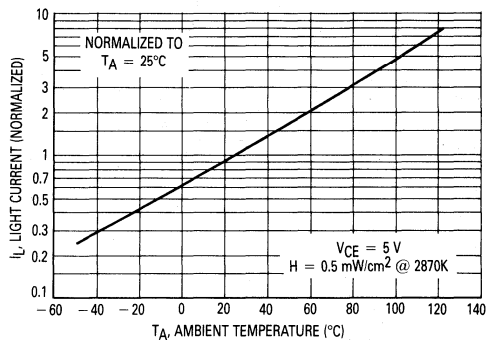

Figure 4. Normalized Light Current versus Temperature

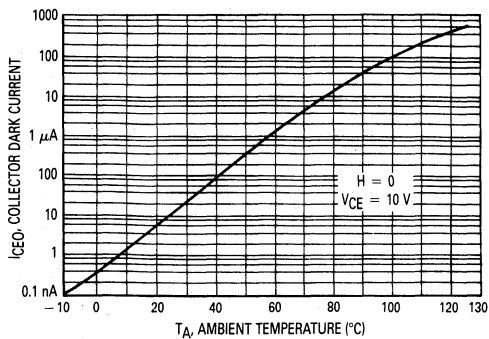

Figure 5. Dark Current versus Temperature

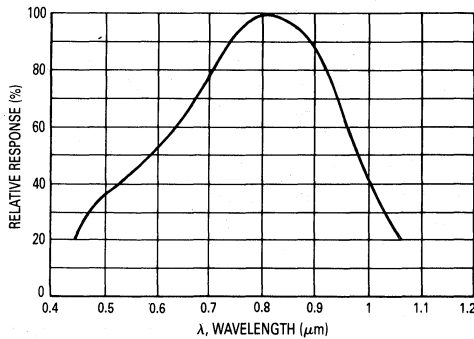

Figure 6. Constant Energy Spectral Response

4

MRD360, MRD370

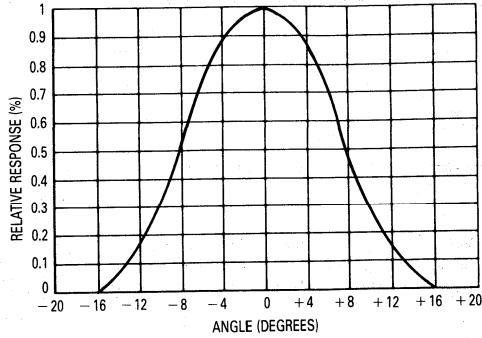

Figure 7. Angular Response

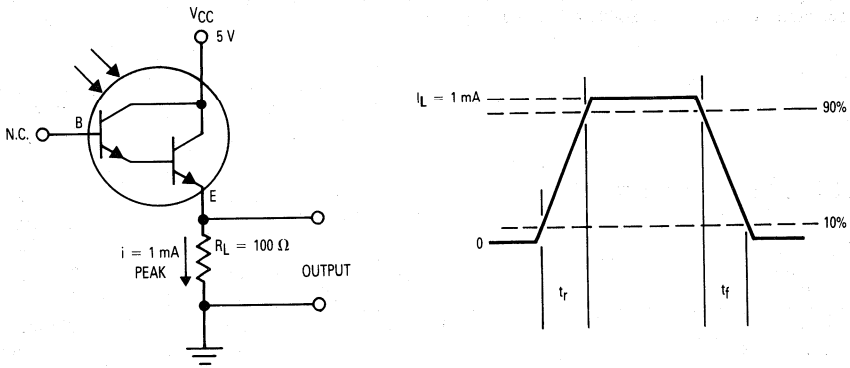
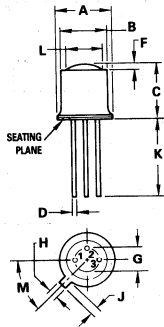

Figure 8. Pulse Response Test Circuit and Waveform

OUTLINE DIMENSIONS



NOTES:

- LEADS WITHIN .13 mm (.005) RADIUS OF TRUE POSITION AT SEATING PLANE, AT MAXIMUM MATERIAL CONDITION.
- PIN 3 INTERNALLY CONNECTED TO CASE.

STYLE 1:

- PIN 1. EMITTER
- BASE
- COLLECTOR

| DIM | MILLIMETERS | | INCHES | |
|-----|-------------|------|-----------|-------|
| | MIN | MAX | MIN | MAX |
| A | 5.31 | 5.84 | 0.209 | 0.230 |
| B | 4.52 | 4.95 | 0.178 | 0.195 |
| C | 4.57 | 6.48 | 0.180 | 0.255 |
| D | 0.41 | 0.48 | 0.016 | 0.019 |
| F | — | 1.14 | — | 0.045 |
| G | 2.54 BSC | | 0.100 BSC | |
| H | 0.99 | 1.17 | 0.039 | 0.046 |
| J | 0.84 | 1.22 | 0.033 | 0.048 |
| K | 12.70 | — | 0.500 | — |
| L | 3.35 | 4.01 | 0.132 | 0.158 |
| M | 45° BSC | | 45° BSC | |

CASE 82-05
METAL

Photo Detectors Diode Output

... designed for application in laser detection, light demodulation, detection of visible and near infrared light-emitting diodes, shaft or position encoders, switching and logic circuits, or any design requiring radiation sensitivity, ultra high-speed, and stable characteristics.

- Ultra Fast Response — (<1 ns Typ)
- High Sensitivity — MRD500 (1.2 $\mu\text{A}/\text{mW}/\text{cm}^2$ Min)
 MRD510 (0.3 $\mu\text{A}/\text{mW}/\text{cm}^2$ Min)
- Available With Convex Lens (MRD500) or Flat Glass (MRD510) for Design Flexibility
- Popular TO-18 Type Package for Easy Handling and Mounting
- Sensitive Throughout Visible and Near Infrared Spectral Range for Wide Application
- Annular Passivated Structure for Stability and Reliability

MRD500
MRD510

PHOTO DETECTORS
DIODE OUTPUT
PIN SILICON
250 MILLIWATTS
100 VOLTS

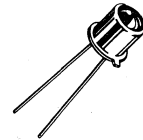

CASE 209-01
MRD500
(CONVEX LENS)



CASE 210-01
MRD510
(FLAT GLASS)

4

MAXIMUM RATINGS ($T_A = 25^\circ\text{C}$ unless otherwise noted)

| Rating | Symbol | Value | Unit |
|---|------------------|-------------|----------------------------|
| Reverse Voltage | V_R | 100 | Volts |
| Total Power Dissipation @ $T_A = 25^\circ\text{C}$ Derate above 25°C | P_D | 250 2.27 | mW mW/ $^\circ\text{C}$ |
| Operating Temperature Range | T_A | -55 to +125 | $^\circ\text{C}$ |
| Storage Temperature Range | T_{stg} | -65 to +150 | $^\circ\text{C}$ |

STATIC ELECTRICAL CHARACTERISTICS ($T_A = 25^\circ\text{C}$ unless otherwise noted)

| Characteristic | Fig. No. | Symbol | Min | Typ | Max | Unit |
|--|----------|--------------------|--------|---------|--------|-------|
| Dark Current ($V_R = 20\text{ V}$, $R_L = 1\text{ megohm}$) Note 2 $T_A = 25^\circ\text{C}$ $T_A = 100^\circ\text{C}$ | 2 and 3 | I_D | — — | — 14 | 2 — | nA |
| Reverse Breakdown Voltage ($I_R = 10\text{ }\mu\text{A}$) | — | $V_{(\text{BR})R}$ | 100 | 200 | — | Volts |
| Forward Voltage ($I_F = 50\text{ mA}$) | — | V_F | — | — | 1.1 | Volts |
| Series Resistance ($I_F = 50\text{ mA}$) | — | R_S | — | — | 10 | Ohms |
| Total Capacitance ($V_R = 20\text{ V}$, $f = 1\text{ MHz}$) | 5 | C_T | — | — | 4 | pF |

OPTICAL CHARACTERISTICS ($T_A = 25^\circ\text{C}$ unless otherwise noted)

| Characteristic | MRD500 MRD510 | Fig. No. | Symbol | Min | Typ | Max | Unit |
|---|------------------|----------|--|----------|------------|--------|-------------------------------------|
| Light Current ($V_R = 20\text{ V}$) Note 1 | MRD500 MRD510 | 1 | I_L | 6 1.5 | 9 2.1 | — — | μA |
| Sensitivity at $0.8\text{ }\mu\text{m}$ ($V_R = 20\text{ V}$) Note 3 | MRD500 MRD510 | — | $S_{(\lambda=0.8\text{ }\mu\text{m})}$ | — — | 6.6 1.5 | — — | $\mu\text{A}/\text{mW}/\text{cm}^2$ |
| Response Time ($V_R = 20\text{ V}$, $R_L = 50\text{ Ohms}$) | — | — | $t_{(\text{resp})}$ | — | 1 | — | ns |
| Wavelength of Peak Spectral Response | — | 5 | λ_s | — | 0.8 | — | μm |

NOTES: 1. Radiation Flux Density (H) equal to $5\text{ mW}/\text{cm}^2$ emitted from a tungsten source at a color temperature of 2870 K .
 2. Measured under dark conditions. ($H = 0$).
 3. Radiation Flux Density (H) equal to $0.5\text{ mW}/\text{cm}^2$ at $0.8\text{ }\mu\text{m}$.

MRD500, MRD510

TYPICAL CHARACTERISTICS

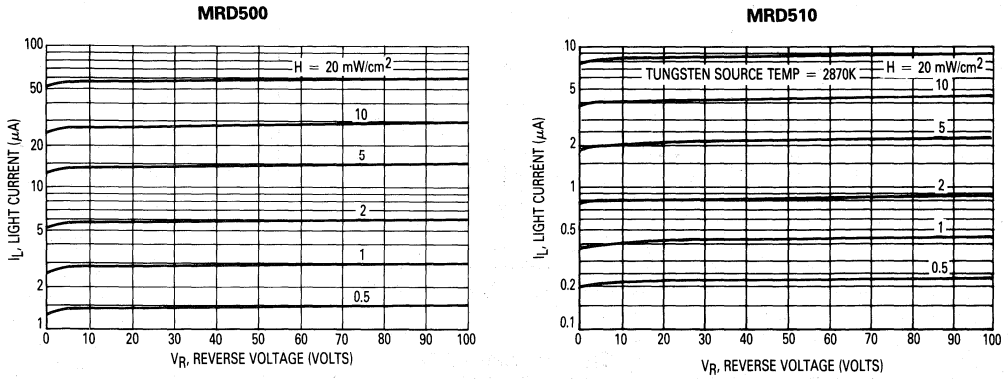

Figure 1. Irradiated Voltage — Current Characteristic

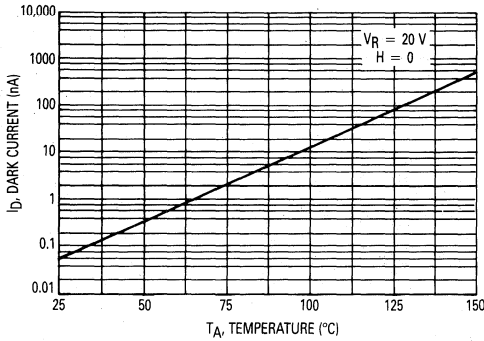

Figure 2. Dark Current versus Temperature

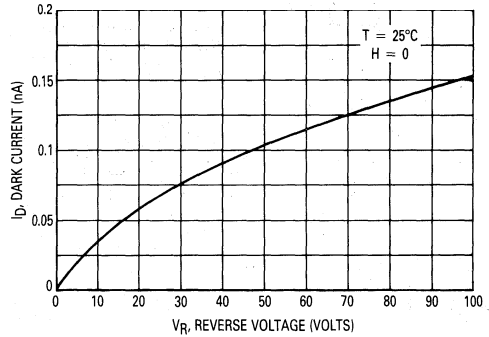

Figure 3. Dark Current versus Reverse Voltage

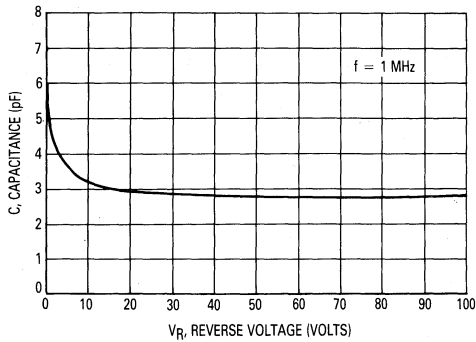

Figure 4. Capacitance versus Voltage

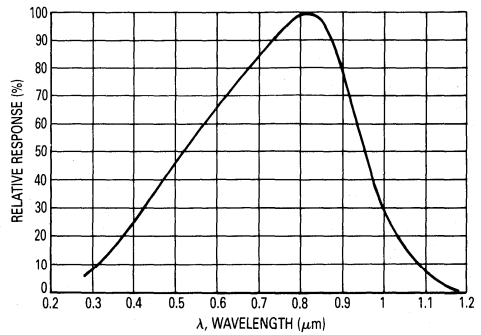

Figure 5. Relative Spectral Response

4

MRD500, MRD510

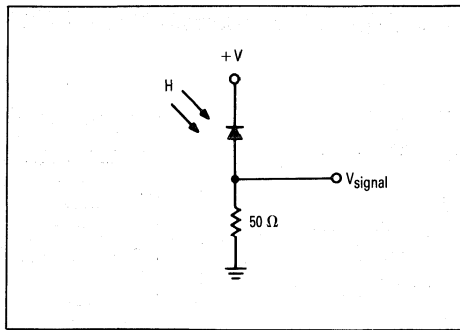

Figure 6. Typical Operating Circuit

OUTLINE DIMENSIONS

**CASE 209-01
MRD500
(CONVEX LENS)**

NOTES:
1. PIN 2 INTERNALLY CONNECTED TO CASE
2. LEADS WITHIN 0.13 mm (0.005) RADIUS OF TRUE POSITION AT SEATING PLANE AT MAXIMUM MATERIAL CONDITION.

| DIM | MILLIMETERS | | INCHES | |
|-----|-------------|------|-----------|-------|
| | MIN | MAX | MIN | MAX |
| A | 5.31 | 5.84 | 0.209 | 0.230 |
| B | 4.52 | 4.95 | 0.178 | 0.195 |
| C | 5.08 | 6.35 | 0.200 | 0.250 |
| D | 0.41 | 0.48 | 0.016 | 0.019 |
| F | 0.51 | 1.02 | 0.020 | 0.040 |
| G | 2.54 BSC | | 0.100 BSC | |
| H | 0.99 | 1.17 | 0.039 | 0.046 |
| J | 0.84 | 1.22 | 0.033 | 0.048 |
| K | 12.70 | — | 0.500 | — |
| L | 3.35 | 4.01 | 0.132 | 0.158 |
| M | 45° BSC | | 45° BSC | |

STYLE 1:
PIN 1. ANODE
2. CATHODE

**CASE 210-01
MRD510
(FLAT GLASS)**

NOTES:
1. PIN 2 INTERNALLY CONNECTED TO CASE.
2. LEADS WITHIN 0.13 (0.005) RADIUS OF TRUE POSITION AT SEATING PLANE AT MAXIMUM MATERIAL CONDITION.

| DIM | MILLIMETERS | | INCHES | |
|-----|-------------|------|-----------|-------|
| | MIN | MAX | MIN | MAX |
| A | 5.31 | 5.84 | 0.209 | 0.230 |
| B | 4.52 | 4.95 | 0.178 | 0.195 |
| C | 4.57 | 5.33 | 0.180 | 0.210 |
| D | 0.41 | 0.48 | 0.016 | 0.019 |
| G | 2.54 BSC | | 0.100 BSC | |
| H | 0.99 | 1.17 | 0.039 | 0.046 |
| J | 0.84 | 1.22 | 0.033 | 0.048 |
| K | 12.70 | — | 0.500 | — |
| M | 45° BSC | | 45° BSC | |

STYLE 1:
PIN 1. ANODE
2. CATHODE

4

Photo Detector Transistor Output

... designed for industrial processing and control applications such as light modulators, shaft or position encoders, end of tape detectors. The MRD701 is designed to be used with the MLED71 infrared emitter in optical slotted coupler/interrupter applications.

- Economical, Miniature Plastic Package
- Package Designed for Accurate Positioning
- Lens Molded into Package

MRD701

**PHOTO DETECTOR
 TRANSISTOR OUTPUT
 NPN SILICON
 30 VOLTS**

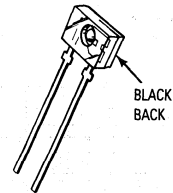

**CASE 349-01
 PLASTIC**

4

MAXIMUM RATINGS

| Rating | Symbol | Value | Unit |
|---|----------------|-------------|----------------------------|
| Collector-Emitter Voltage | V_{CE0} | 30 | Volts |
| Total Device Dissipation @ $T_A = 25^\circ\text{C}$ Derate above 25°C (Note 1) | P_D | 150 2 | mW mW/ $^\circ\text{C}$ |
| Operating and Storage Junction Temperature Range | T_J, T_{stg} | -40 to +100 | $^\circ\text{C}$ |
| Lead Soldering Temperature (5 sec max, 1/16" from case) (Note 2) | — | 260 | $^\circ\text{C}$ |

ELECTRICAL CHARACTERISTICS ($T_A = 25^\circ\text{C}$ unless otherwise noted)

| Characteristic | Symbol | Min | Typ | Max | Unit |
|---|---------------|-----|-----|-----|-------|
| Collector Dark Current ($V_{CE} = 10\text{ V}, H \approx 0$) | I_D | — | — | 100 | nA |
| Collector-Emitter Breakdown Voltage ($I_C = 10\text{ mA}, H \approx 0$) | $V_{(BR)CEO}$ | 30 | — | — | Volts |

OPTICAL CHARACTERISTICS ($T_A = 25^\circ\text{C}$ unless otherwise noted)

| | | | | | | |
|---|--|-----------|------|-----|---------------|---------------|
| Collector Light Current ($V_{CE} = 5\text{ V}, H = 500\ \mu\text{W}/\text{cm}^2$) | I_L | 100 | 500 | — | μA | |
| Turn-On Time Turn-Off Time | $H = 5\text{ mW}/\text{cm}^2, V_{CC} = 5\text{ V}$ $R_L = 2400\ \Omega$ | t_{on} | — | 10 | — | μs |
| | | t_{off} | — | 60 | — | μs |
| Saturation Voltage ($H = 10\text{ mW}/\text{cm}^2, I_C = 2\text{ mA}, V_{CC} = 5\text{ V}$) | $V_{CE(sat)}$ | — | 0.25 | 0.4 | Volts | |
| Wavelength of Maximum Sensitivity | λ_s | — | 0.8 | — | μm | |

Notes: 1. Measured with device soldered into a typical PC board.

2. Heat sink should be applied to leads during soldering to prevent case temperature from exceeding 100°C .

MRD701

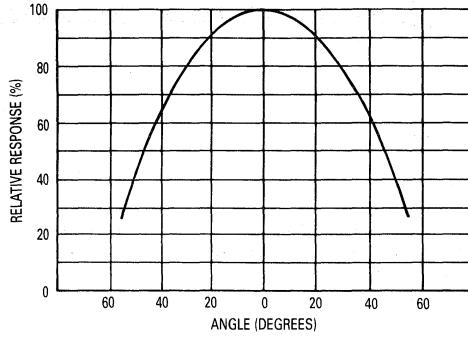

Figure 1. Angular Response

TYPICAL COUPLED CHARACTERISTICS USING MLED71 EMITTER AND MRD701 PHOTOTRANSISTOR DETECTOR

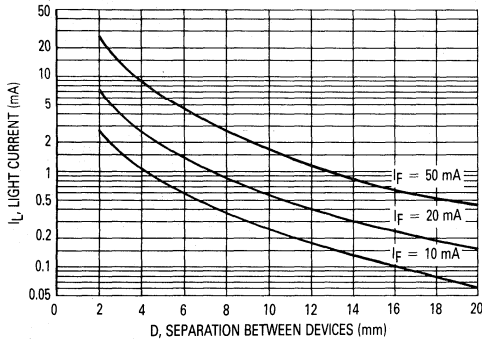

Figure 2. Continuous MRD701 Collector Light Current versus Distance from MLED71

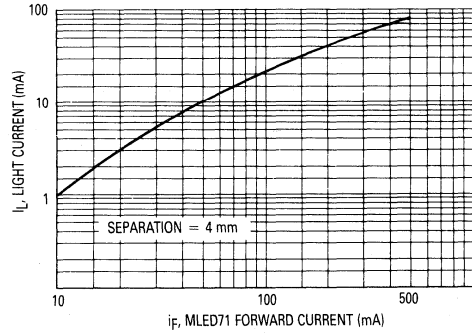
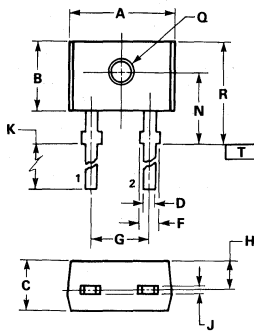

Figure 3. Instantaneous MRD701 Collector Light Current versus MLED71 Forward Current

OUTLINE DIMENSIONS

CASE 349-01
PLASTIC



NOTES:

- DIMENSIONS A, B AND C ARE DATUMS.
- POSITIONAL TOLERANCE FOR D DIMENSION:
 ± 0.25 (0.010) (M) -T: A (M) C (M)
- POSITIONAL TOLERANCE FOR Q DIAMETER:
 ± 0.25 (0.010) (M) A (M) B (M)
- T- IS SEATING PLANE.
- DIMENSIONING AND TOLERANCING PER ANSI Y14.5, 1973.

STYLE 2:
PIN 1. EMITTER
2. COLLECTOR

| DIM | MILLIMETERS | | INCHES | |
|-----|-------------|-------|-----------|-------|
| | MIN | MAX | MIN | MAX |
| A | 3.43 | 4.60 | 0.135 | 0.185 |
| B | 2.79 | 3.30 | 0.110 | 0.130 |
| C | 2.03 | 3.18 | 0.080 | 0.125 |
| D | 0.43 | 0.60 | 0.017 | 0.024 |
| F | 1.14 | 1.40 | 0.045 | 0.055 |
| G | 2.54 BSC | | 0.100 BSC | |
| H | 1.52 BSC | | 0.060 BSC | |
| J | 0.23 | 0.56 | 0.009 | 0.022 |
| K | 12.83 | 19.05 | 0.505 | 0.750 |
| N | 3.05 | 3.30 | 0.120 | 0.130 |
| Q | 0.76 | 1.52 | 0.030 | 0.060 |
| R | 3.81 | 4.60 | 0.150 | 0.185 |

Photo Detector Darlington Output

... designed for a wide variety of industrial processing and control applications requiring a sensitive detector. The MRD711 is in an identical package and is designed for use with the MLED71 infrared emitter.

- Miniature, Low Profile, Clear Plastic Package
- Designed for Automatic Handling and Accurate Positioning
- Side Looking, with Molded Lens
- High Volume, Economical

MRD711

**PHOTO DETECTOR
DARLINGTON OUTPUT
NPN SILICON
60 VOLTS**

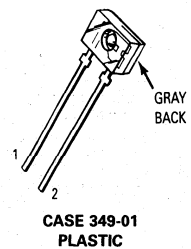

4

MAXIMUM RATINGS ($T_A = 25^\circ\text{C}$ unless otherwise noted)

| Rating | Symbol | Value | Unit |
|---|----------------|-------------|----------------------------|
| Collector-Emitter Voltage | V_{CEO} | 60 | Volts |
| Total Device Dissipation @ $T_A = 25^\circ\text{C}$ Derate above 25°C (Note 1) | P_D | 150 2 | mW mW/ $^\circ\text{C}$ |
| Operating and Storage Junction Temperature Range | T_J, T_{stg} | -40 to +100 | $^\circ\text{C}$ |
| Lead Soldering Temperature (5 sec. max, 1/16" from case) (Note 2) | — | 260 | $^\circ\text{C}$ |

ELECTRICAL CHARACTERISTICS ($T_A = 25^\circ\text{C}$ unless otherwise noted)

| Characteristic | Symbol | Min | Typ | Max | Unit |
|--|---------------|-----|-----|-----|-------|
| Collector Dark Current ($V_{CE} = 10\text{ V}, H \approx 0$) | I_D | — | — | 100 | nA |
| Collector-Emitter Breakdown Voltage ($I_C = 1\text{ mA}, H \approx 0$) | $V_{(BR)CEO}$ | 60 | — | — | Volts |
| Capacitance ($V_{CC} = 5\text{ V}, f = 1\text{ MHz}$) | C_{ce} | — | 3.9 | — | pF |

OPTICAL CHARACTERISTICS ($T_A = 25^\circ\text{C}$ unless otherwise noted)

| | | | | | | |
|--|--|-----------|------|-----|---------------|---------------|
| Collector Light Current ($V_{CE} = 5\text{ V}, H = 500\ \mu\text{W}/\text{cm}^2, \lambda = 940\text{ nm}$) | I_L | 5 | 25 | — | mA | |
| Turn-On Time | $H = 500\ \mu\text{W}/\text{cm}^2, V_{CC} = 5\text{ V}$ $R_L = 100\ \Omega$ | t_{on} | — | 125 | — | μs |
| Turn-Off Time | | t_{off} | — | 150 | — | |
| Saturation Voltage ($H = 500\ \mu\text{W}/\text{cm}^2, \lambda = 940\text{ nm}, I_C = 2\text{ mA}, V_{CC} = 5\text{ V}$) | $V_{CE(sat)}$ | — | 0.75 | 1 | Volts | |
| Wavelength of Maximum Sensitivity | λ_s | — | 0.8 | — | μm | |

Notes: 1. Measured with device soldered into a typical printed circuit board.

2. Heat sink should be applied to leads during soldering to prevent case temperature from exceeding 100°C .

MRD711

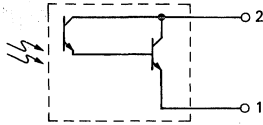

Figure 1. Typical Operating Circuit

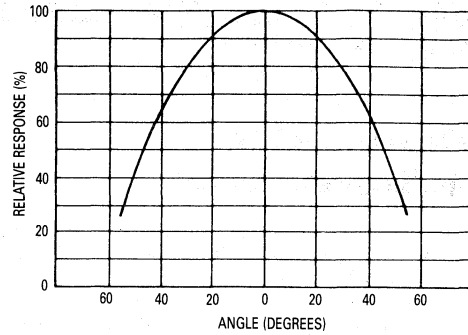

Figure 2. Angular Response

TYPICAL COUPLED CHARACTERISTICS USING MLED71 EMITTER AND MRD711 PHOTODARLINGTON DETECTOR

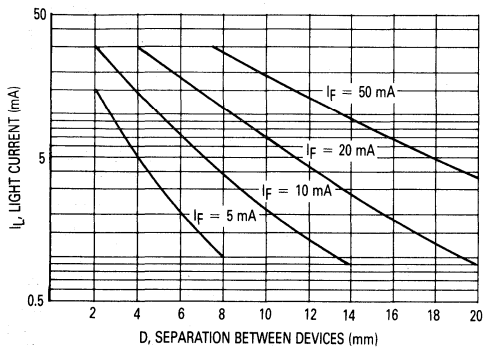

Figure 3. Continuous MRD711 Collector Light Current versus Distance from MLED71

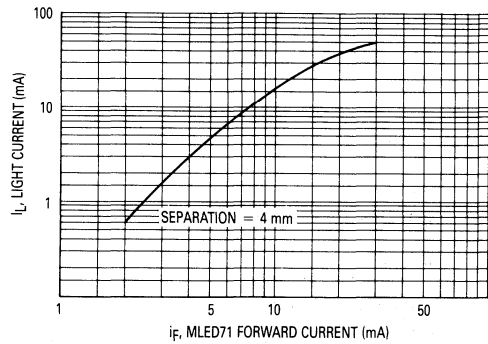
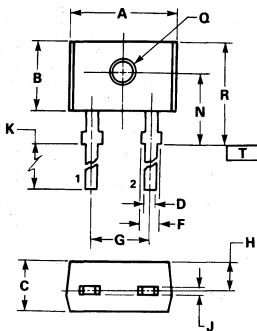

Figure 4. Instantaneous MRD711 Collector Light Current versus MLED71 Forward Current

OUTLINE DIMENSIONS

CASE 349-01 PLASTIC



- NOTES:
- DIMENSIONS A, B AND C ARE DATUMS.
 - POSITIONAL TOLERANCE FOR D DIMENSION:
 $\phi \pm 0.25 (0.010) \text{ (M) } \text{---T} \text{---} \text{---A} \text{---} \text{---} \text{---C} \text{---} \text{---} \text{---}$
 - POSITIONAL TOLERANCE FOR Q DIAMETER:
 $\phi \pm 0.25 (0.010) \text{ (M) } \text{---A} \text{---} \text{---} \text{---B} \text{---} \text{---} \text{---}$
 - T--- IS SEATING PLANE.
 - DIMENSIONING AND TOLERANCING PER ANSI Y14.5, 1973.

STYLE 2:
PIN 1. EMITTER
PIN 2. COLLECTOR

| DIM | MILLIMETERS | | INCHES | |
|-----|-------------|-------|-----------|-------|
| | MIN | MAX | MIN | MAX |
| A | 3.43 | 4.60 | 0.135 | 0.185 |
| B | 2.79 | 3.30 | 0.110 | 0.130 |
| C | 2.03 | 3.18 | 0.080 | 0.125 |
| D | 0.43 | 0.60 | 0.017 | 0.024 |
| F | 1.14 | 1.40 | 0.045 | 0.055 |
| G | 2.54 BSC | | 0.100 BSC | |
| H | 1.52 BSC | | 0.060 BSC | |
| J | 0.23 | 0.56 | 0.009 | 0.022 |
| K | 12.83 | 19.05 | 0.505 | 0.750 |
| N | 3.05 | 3.30 | 0.120 | 0.130 |
| Q | 0.76 | 1.52 | 0.030 | 0.060 |
| R | 3.81 | 4.60 | 0.150 | 0.185 |

Photo Detector PIN Diode Output

MRD721

... designed for application in laser detection, light demodulation, detection of visible and near infrared light-emitting diodes, shaft or position encoders, switching and logic circuits, or any design requiring radiation sensitivity, ultra high-speed, and stable characteristics.

**PHOTO DETECTOR
 DIODE OUTPUT
 100 VOLTS**

- Ultra Fast Response — (<1 ns Typ)
- Sensitive Throughout Visible and Near Infrared Spectral Range for Wide Application
- Annular Passivated Structure for Stability and Reliability
- Economical, Low Profile, Miniature Plastic Package
- Lens Molded Into Package
- Designed for Automatic Handling and Accurate Positioning

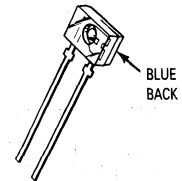

**CASE 349-01
 PLASTIC**

4

MAXIMUM RATINGS ($T_A = 25^\circ\text{C}$ unless otherwise noted)

| Rating | Symbol | Value | Unit |
|--|----------------|-------------|-------------|
| Reverse Voltage | V_R | 100 | Volts |
| Total Power Dissipation @ $T_A = 25^\circ\text{C}$ Derate above 25°C (Note 1) | P_D | 150 2 | mW mW/°C |
| Operating and Storage Junction Temperature Range | T_J, T_{stg} | -40 to +100 | °C |
| Lead Soldering Temperature (5 sec. max, 1/16" from case) (Note 2) | — | 260 | °C |

ELECTRICAL CHARACTERISTICS ($T_A = 25^\circ\text{C}$ unless otherwise noted)

| Characteristic | Fig. No. | Symbol | Min | Typ | Max | Unit |
|---|----------|-------------|--------|------------|---------|-------|
| Dark Current ($V_R = 20\text{ V}, R_L = 1\text{ M}\Omega$; Note 3) $T_A = 25^\circ\text{C}$ $T_A = 100^\circ\text{C}$ | 3 and 4 | I_D | — — | 0.06 14 | 10 — | nA |
| Reverse Breakdown Voltage ($I_R = 10\ \mu\text{A}$) | — | $V_{(BR)R}$ | 100 | 200 | — | Volts |
| Forward Voltage ($I_F = 50\text{ mA}$) | — | V_F | — | — | 1.1 | Volts |
| Series Resistance ($I_F = 50\text{ mA}$) | — | R_S | — | 8 | — | Ohms |
| Total Capacitance ($V_R = 20\text{ V}; f = 1\text{ MHz}$) | 5 | C_T | — | 3 | — | pF |

OPTICAL CHARACTERISTICS ($T_A = 25^\circ\text{C}$)

| | | | | | | |
|---|---|----------------------------------|-----|-----|---|-----------------------|
| Light Current ($V_R = 20\text{ V}$, Note 4) | 2 | I_L | 1.5 | 4 | — | μA |
| Sensitivity ($V_R = 20\text{ V}$, Note 5) | — | $S(\lambda = 0.8\ \mu\text{m})$ | — | 5 | — | $\mu\text{A/mW/cm}^2$ |
| | — | $S(\lambda = 0.94\ \mu\text{m})$ | — | 1.2 | — | $\mu\text{A/mW/cm}^2$ |
| Response Time ($V_R = 20\text{ V}, R_L = 50\ \Omega$) | — | $t_{(resp)}$ | — | 1 | — | ns |
| Wavelength of Peak Spectral Response | 6 | λ_S | — | 0.8 | — | μm |

- Notes: 1. Measured with the device soldered into a typical printed circuit board.
 2. Heat sink should be applied to leads during soldering to prevent case temperature from exceeding 100°C .
 3. Measured under dark conditions. ($H \approx 0$).
 4. Radiation Flux Density (H) equal to 5 mW/cm^2 emitted from a tungsten source at a color temperature of 2870 K .
 5. Radiation Flux Density (H) equal to 0.5 mW/cm^2 .

TYPICAL CHARACTERISTICS

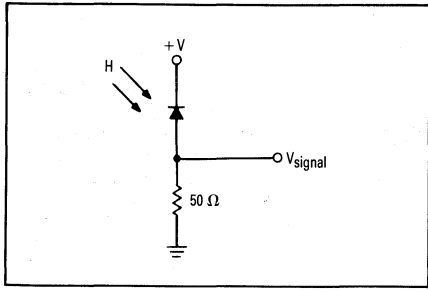

Figure 1. Operating Circuit

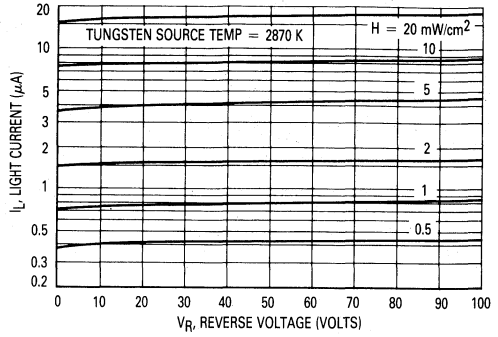

Figure 2. Irradiated Voltage — Current Characteristic

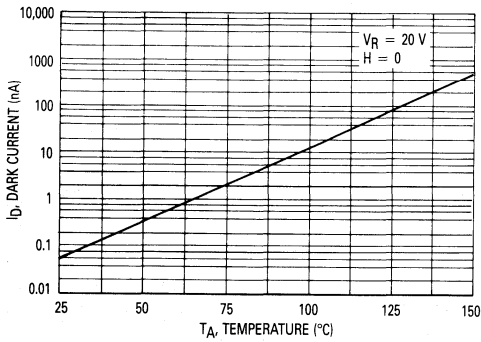

Figure 3. Dark Current versus Temperature

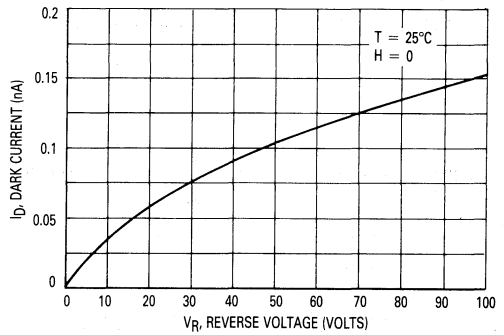

Figure 4. Dark Current versus Reverse Voltage

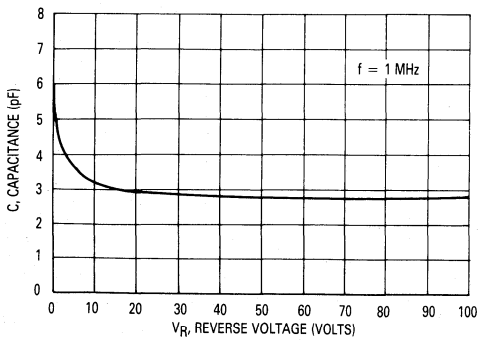

Figure 5. Capacitance versus Voltage

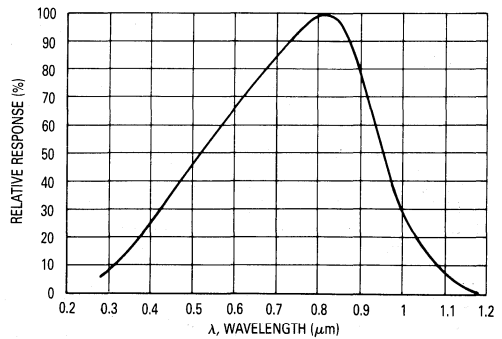

Figure 6. Relative Spectral Response

4

MRD721

OUTLINE DIMENSIONS

CASE 349-01 PLASTIC

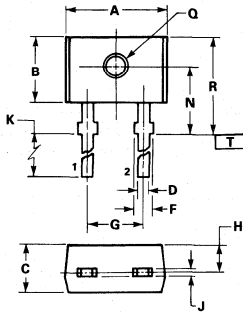

NOTES:

1. DIMENSIONS A, B AND C ARE DATUMS.
2. POSITIONAL TOLERANCE FOR D DIMENSION:
 $\pm 0.25 (0.010) \text{ (M)} \text{ } \text{---T} \text{ } \text{---} | \text{ } \text{---A} \text{ } \text{---} | \text{ } \text{---C} \text{ } \text{---}$
3. POSITIONAL TOLERANCE FOR Q DIAMETER:
 $\pm 0.25 (0.010) \text{ (M)} \text{ } \text{---A} \text{ } \text{---} | \text{ } \text{---B} \text{ } \text{---}$
4. $\text{---T} \text{ } \text{---}$ IS SEATING PLANE.
5. DIMENSIONING AND TOLERANCING PER ANSI Y14.5, 1973.

| DIM | MILLIMETERS | | INCHES | |
|-----|-------------|-------|-----------|-------|
| | MIN | MAX | MIN | MAX |
| A | 3.43 | 4.60 | 0.135 | 0.185 |
| B | 2.79 | 3.30 | 0.110 | 0.130 |
| C | 2.03 | 3.18 | 0.080 | 0.125 |
| D | 0.43 | 0.60 | 0.017 | 0.024 |
| F | 1.14 | 1.40 | 0.045 | 0.055 |
| G | 2.54 BSC | | 0.100 BSC | |
| H | 1.52 BSC | | 0.060 BSC | |
| J | 0.23 | 0.56 | 0.009 | 0.022 |
| K | 12.83 | 19.05 | 0.505 | 0.750 |
| N | 3.05 | 3.30 | 0.120 | 0.130 |
| Q | 0.76 | 1.52 | 0.030 | 0.060 |
| R | 3.81 | 4.60 | 0.150 | 0.185 |

STYLE 1:
PIN 1. CATHODE
PIN 2. ANODE

Photo Detector Logic Output

... incorporates a Schmitt Trigger which provides hysteresis for noise immunity and pulse shaping. The detector circuit is optimized for simplicity of operation and utilizes an open-collector output for application flexibility.

- Popular Low Cost Plastic Package
- High Coupling Efficiency
- Wide V_{CC} Range
- Ideally Suited for MLED71 Emitter
- Usable to 125 kHz

MRD750

**PHOTO DETECTOR
 LOGIC OUTPUT**



**CASE 349C-01
 PLASTIC**

MAXIMUM RATINGS ($T_A = 25^\circ\text{C}$ unless otherwise noted)

| Rating | Symbol | Value | Unit |
|---|-----------|-------------|----------------------------|
| Output Voltage Range | V_O | 0-16 | Volts |
| Supply Voltage Range | V_{CC} | 0-16 | Volts |
| Output Current | I_O | 50 | mA |
| Device Dissipation Derate above 25°C (Note 1) | P_D | 150 2 | mW mW/ $^\circ\text{C}$ |
| Maximum Operating Temperature | T_A | -40 to +85 | $^\circ\text{C}$ |
| Storage Temperature Range | T_{stg} | -40 to +100 | $^\circ\text{C}$ |
| Lead Soldering Temperature (5 seconds maximum; 1/16 inch from case) (Note 2) | T_L | 260 | $^\circ\text{C}$ |

Notes: 1. Measured with device soldered into a typical PC board.
 2. Heat sink should be applied to leads during soldering to prevent case temperature from exceeding 100°C .

ELECTRICAL CHARACTERISTICS ($T_A = 25^\circ\text{C}$ unless otherwise noted)

| Characteristic | Symbol | Min | Typ | Max | Unit |
|--|----------------------|-----|-----|-----|---------------|
| DEVICE ($T_A = 25^\circ\text{C}$) | | | | | |
| Operating Voltage | V_{CC} | 3 | — | 15 | Volts |
| Supply Current with Output High, Figure 4 ($I_F = 0$, $V_{CC} = 5\text{ V}$) | $I_{CC(\text{off})}$ | — | 1.3 | 5 | mA |
| Output Current, High ($I_F = 0$, $V_{CC} = V_O = 15\text{ V}$, $R_L = 270\ \Omega$) | I_{OH} | — | — | 100 | μA |

(continued)

MRD750

ELECTRICAL CHARACTERISTICS — continued ($T_A = 25^\circ\text{C}$ unless otherwise noted)

| Characteristic | Symbol | Min | Typ | Max | Unit |
|---|------------|-----|------|-----|--------------------|
| COUPLED ($T_A = 0-70^\circ\text{C}$) | | | | | |
| Light Required to Trigger (Tungsten Source, 2870 K) | $H_{(on)}$ | — | 0.50 | — | mW/cm ² |

The following characteristics are measured with an MLED71 emitter at a separation distance of 4 mm (0.155 inches) with the lenses of the emitter and detector on a common axis within 0.1 mm and parallel within 5 degrees.

| | | | | | | |
|--|---|-----------|------|-----|-------|---------------|
| Supply Current with Output Low, Figure 5 ($I_F = I_{F(on)}$, $V_{CC} = 5\text{ V}$) | $I_{CC(on)}$ | — | 3 | 5 | mA | |
| Output Voltage, Low ($R_L = 270\ \Omega$, $V_{CC} = 5\text{ V}$, $I_F = I_{F(on)}$) | V_{OL} | — | 0.2 | 0.4 | volts | |
| Threshold Current, ON ($R_L = 270\ \Omega$, $V_{CC} = 5\text{ V}$) | $I_{F(on)}$ | — | 10 | 20 | mA | |
| Threshold Current, OFF ($R_L = 270\ \Omega$, $V_{CC} = 5\text{ V}$) | $I_{F(off)}$ | 1 | 7.5 | — | mA | |
| Hysteresis Ratio, Figure 1 ($R_L = 270\ \Omega$, $V_{CC} = 5\text{ V}$) | $\frac{I_{F(off)}}{I_{F(on)}}$ | — | 0.75 | — | | |
| Turn-On Time | $R_L = 270\ \Omega$, $V_{CC} = 5\text{ V}$, $I_F = I_{F(on)}$, $T_A = 25^\circ\text{C}$ | t_{on} | — | 1.2 | 5 | μs |
| Fall Time | | t_f | — | 0.1 | — | |
| Turn-Off Time | | t_{off} | — | 1.2 | 5 | |
| Rise Time | | t_r | — | 0.1 | — | |

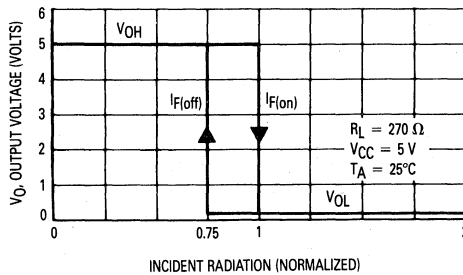

Figure 1. Transfer Characteristics

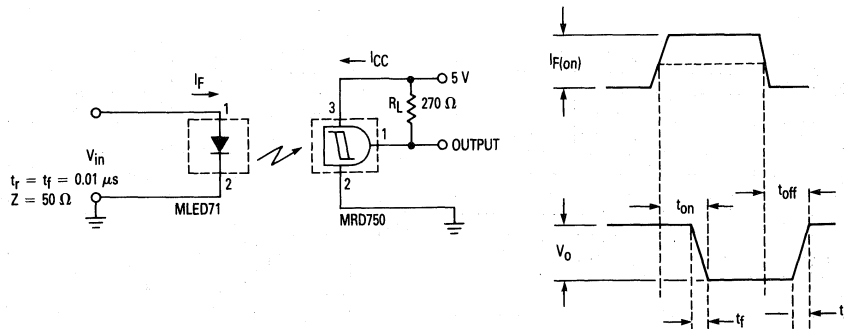

Figure 2. Switching Test Circuit

TYPICAL CHARACTERISTICS

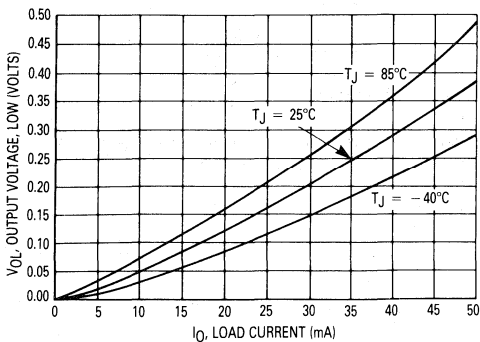

Figure 3. Output Voltage, Low versus Load Current

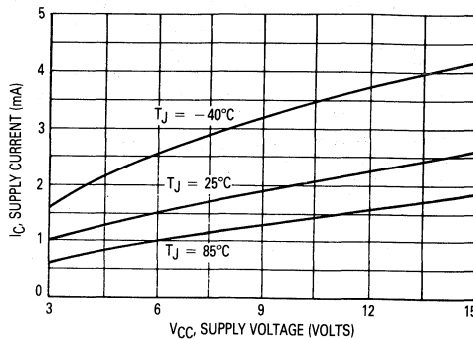

Figure 4. Supply Current versus Supply Voltage — Output High

TYPICAL COUPLED CHARACTERISTICS USING MLED71 EMITTER AND MRD750 DIGITAL OUTPUT DETECTOR

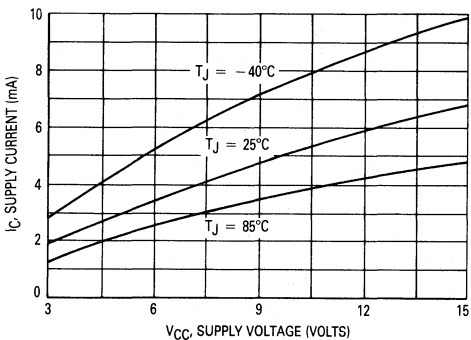

Figure 5. Supply Current versus Supply Voltage — Output Low

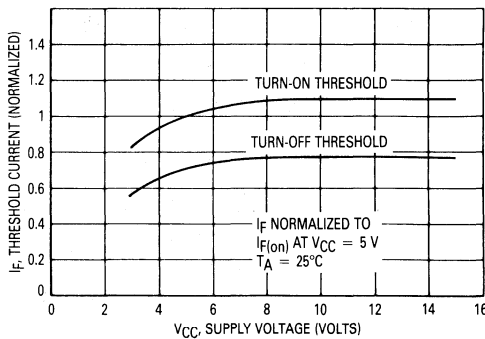

Figure 6. Threshold Current versus Supply Voltage

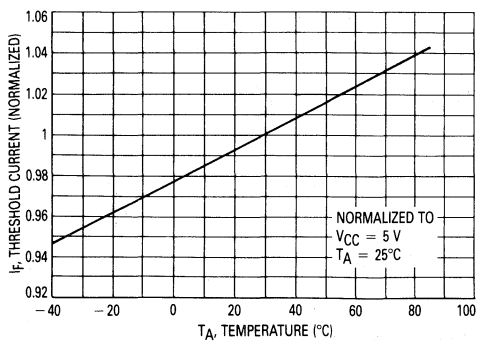

Figure 7. Threshold Current versus Temperature

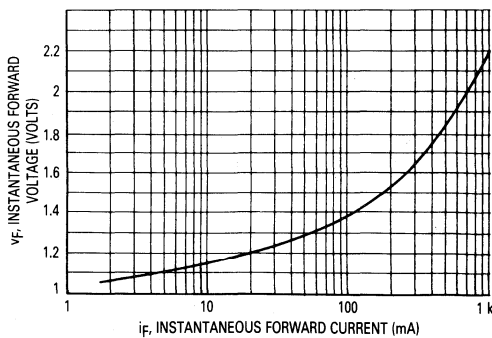

Figure 8. MLED71 Forward Characteristics

MRD750

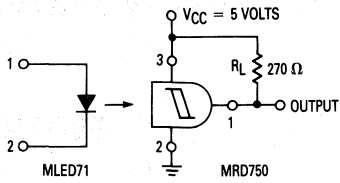

Figure 9. Test Circuit for Threshold Current Measurements

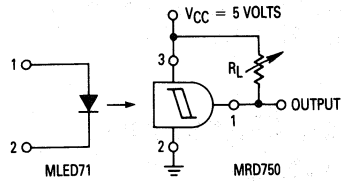

Figure 10. Test Circuit for Output Voltage versus Load Current Measurements

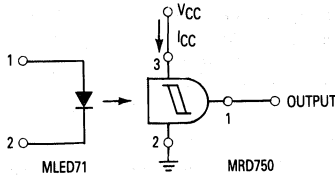
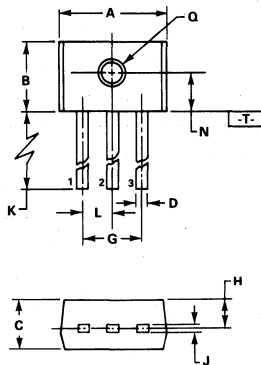

Figure 11. Test Circuit for Supply Current versus Supply Voltage Measurements



STYLE 3:
PIN 1. OUTPUT
2. GROUND
3. VCC

**CASE 349C-01
PLASTIC**

NOTES:

1. DIMENSIONS A, B AND C ARE DATUMS.
2. POSITIONAL TOLERANCE FOR D DIMENSION:
 $\pm \phi 0.25 (0.010) \text{ (M)} \text{ T A } \text{ (M)} \text{ C } \text{ (M)}$
3. POSITIONAL TOLERANCE FOR Q DIMETER:
 $\pm \phi 0.25 (0.010) \text{ (M)} \text{ A } \text{ (M)} \text{ C } \text{ (M)}$
4. -T- IS A SEATING LANE.
5. DIMENSIONING AND TOLERANCING PER ANSI 14.5, 1973.

| DIM | MILLIMETERS | | INCHES | |
|-----|-------------|------|-----------|-------|
| | MIN | MAX | MIN | MAX |
| A | 3.43 | 4.60 | 0.135 | 0.185 |
| B | 2.79 | 3.30 | 0.110 | 0.130 |
| C | 2.03 | 3.18 | 0.080 | 0.125 |
| D | 0.43 | 0.56 | 0.017 | 0.022 |
| G | 2.54 BSC | | 0.100 BSC | |
| H | 1.52 BSC | | 0.060 BSC | |
| J | 0.23 | 0.56 | 0.009 | 0.022 |
| K | 12.70 | — | 0.500 | — |
| L | 1.27 BSC | | 0.050 BSC | |
| N | 1.78 BSC | | 0.070 BSC | |
| Q | 0.76 | 1.52 | 0.030 | 0.060 |

Photo Detector Diode Output

MRD821

This device is designed for infrared remote control and other sensing applications, and can be used in conjunction with the MLED81 infrared emitting diode.

- Low Cost
- Designed for Automated Handling and Accurate Positioning
- Sensitive Throughout the Near Infrared Spectral Range
- Infrared Filter for Rejection of Visible Light
- High Speed

**PHOTO DETECTOR
 DIODE OUTPUT**

MAXIMUM RATINGS

| Rating | Symbol | Value | Unit |
|---|-----------|------------|----------------------------|
| Reverse Voltage | V_R | 35 | Volts |
| Forward Current — Continuous | I_F | 100 | mA |
| Total Power Dissipation ($@ T_A = 25^\circ\text{C}$ Derate above 25°C) | P_D | 150 3.3 | mW mW/ $^\circ\text{C}$ |
| Ambient Operating Temperature Range | T_A | -30 to +70 | $^\circ\text{C}$ |
| Storage Temperature | T_{stg} | -40 to +80 | $^\circ\text{C}$ |
| Lead Soldering Temperature, 5 seconds max, 1/16 inch from case | — | 260 | $^\circ\text{C}$ |

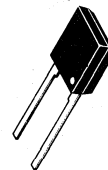

CASE 381-01

ELECTRICAL CHARACTERISTICS ($T_A = 25^\circ\text{C}$ unless otherwise noted)

| Characteristic | Symbol | Min | Typ | Max | Unit |
|--|--------|-----|-----|-----|------|
| Dark Current ($V_R = 10\text{ V}$) | I_D | — | 3 | 30 | nA |
| Capacitance ($f = 1\text{ MHz}$, $V = 0$) | C_J | — | 175 | — | pF |

OPTICAL CHARACTERISTICS ($T_A = 25^\circ\text{C}$ unless otherwise noted)

| Characteristic | Symbol | Min | Typ | Max | Unit |
|---|-----------------|-----|----------|-----|-------------------------------------|
| Wavelength of Maximum Sensitivity | λ_{max} | — | 940 | — | nm |
| Spectral Range | $\Delta\lambda$ | — | 170 | — | nm |
| Sensitivity ($\lambda = 940\text{ nm}$, $V_R = 20\text{ V}$) | S | — | 50 | — | $\mu\text{A}/\text{mW}/\text{cm}^2$ |
| Temperature Coefficient of Sensitivity | ΔS | — | 0.18 | — | %/K |
| Acceptance Half-Angle | ϕ | — | ± 70 | — | $^\circ$ |
| Short Circuit Current ($E_v = 1000\text{ lux}^1$) | I_S | — | 50 | — | μA |
| Open Circuit Voltage ($E_v = 1000\text{ lux}^1$) | V_L | — | 0.3 | — | V |

NOTE 1. E_v is the illumination from an unfiltered tungsten filament source, having a color temperature of 2856K (standard light A, in accordance with DIN5030 and IEC publication 306-1).

TYPICAL CHARACTERISTICS

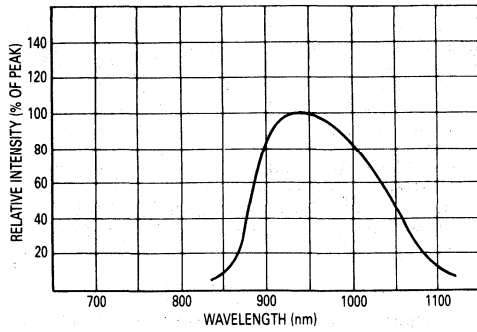

Figure 1. Relative Spectral Sensitivity

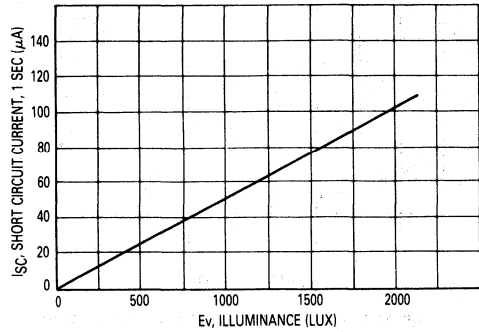

Figure 2. Short Circuit Current versus Illuminance

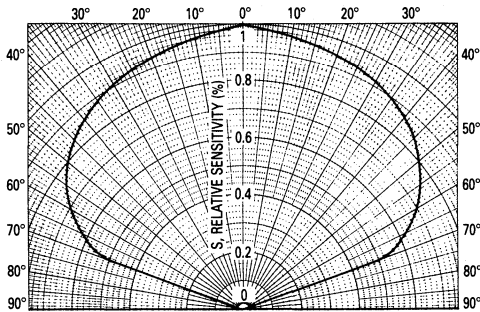

Figure 3. Angular Response

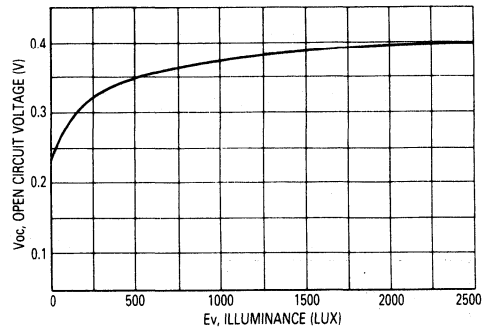

Figure 4. Open Circuit Voltage versus Illuminance

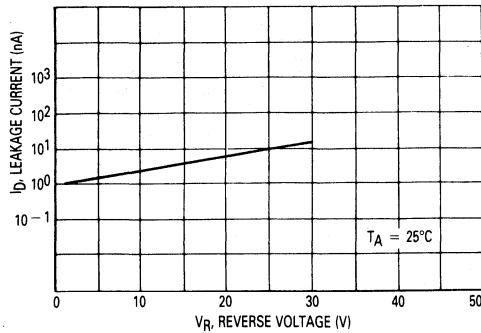

Figure 5. Dark Current versus Reverse Voltage

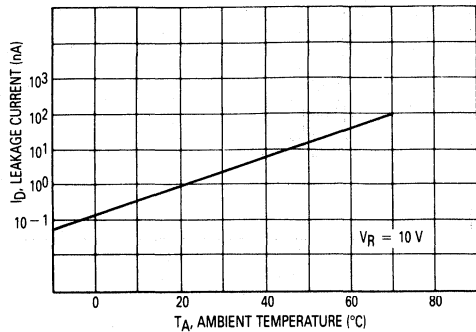

Figure 6. Dark Current versus Temperature



MRD821

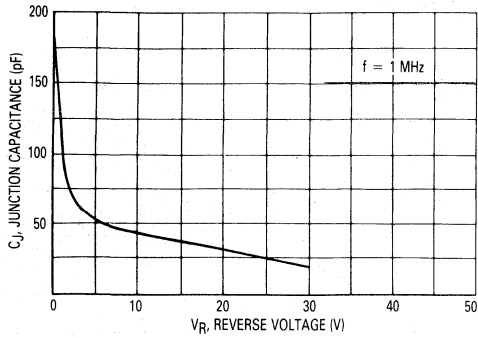

Figure 7. Capacitance versus Reverse Voltage

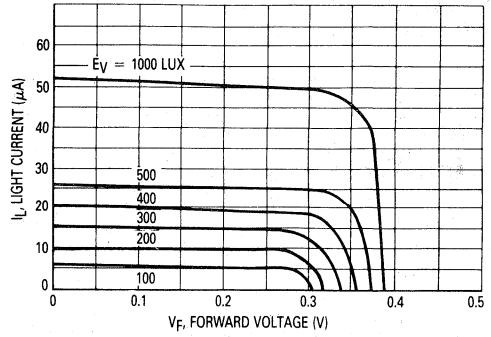

Figure 8. Light Current versus Forward Voltage

4

OUTLINE DIMENSIONS

CASE 381-01

NOTES:

- DIMENSIONING AND TOLERANCING PER ANSI Y14.5M, 1982.
- POSITIONAL TOLERANCE FOR LEAD DIMENSION D:
 $\begin{matrix} \pm 0.25 & (0.010) & \text{Ⓜ} & | & \text{A} & \text{Ⓜ} \end{matrix}$
- CONTROLLING DIMENSION: INCH.

STYLE 1:
 PIN 1. ANODE
 2. CATHODE

| DIM | MILLIMETERS | | INCHES | |
|-----|-------------|-------|-----------|-------|
| | MIN | MAX | MIN | MAX |
| A | 6.81 | 7.21 | 0.268 | 0.284 |
| B | 7.80 | 8.20 | 0.307 | 0.323 |
| C | 2.59 | 2.99 | 0.102 | 0.118 |
| D | 0.51 | 0.76 | 0.020 | 0.030 |
| G | 5.28 BSC | | 0.208 BSC | |
| H | 2.13 | 2.43 | 0.086 | 0.096 |
| J | 0.035 | 0.045 | 0.014 | 0.018 |
| K | 11.99 | 13.39 | 0.472 | 0.551 |
| L | 0.64 | 0.88 | 0.025 | 0.035 |
| C1 | 1.30 | 1.49 | 0.051 | 0.059 |

Photo Detector Triac Driver Output

... designed for applications requiring light and infrared LED TRIAC triggering, small size, and low cost.

- Hermetic Package at Economy Prices
- Popular TO-18 Type Package for Easy Handling and Mounting
- High Trigger Sensitivity
 $H_{FT} = 2 \text{ mW/cm}^2 \text{ Typ}$

MRD3010

**PHOTO DETECTOR
 TRIAC DRIVER OUTPUT
 250 VOLTS**



**CASE 82-05
 METAL**

4

MAXIMUM RATINGS ($T_A = 25^\circ\text{C}$ unless otherwise noted)

| Rating | Symbol | Value | Unit |
|---|-----------|-------------|----------------------------|
| Off-State Output Terminal Voltage | V_{DRM} | 250 | Volts |
| Peak Repetitive Surge Current (PW = 1 ms, 120 pps) | I_{TSM} | 1 | A |
| Total Power Dissipation @ $T_A = 25^\circ\text{C}$ Derate above 25°C | P_D | 250 2.27 | mW mW/ $^\circ\text{C}$ |
| Operating Ambient Temperature Range | T_A | -55 to +85 | $^\circ\text{C}$ |
| Storage Temperature Range | T_{stg} | -65 to +150 | $^\circ\text{C}$ |
| Soldering Temperature (10 s) | — | 260 | $^\circ\text{C}$ |

ELECTRICAL CHARACTERISTICS ($T_A = 25^\circ\text{C}$ unless otherwise noted)

| Characteristic | Symbol | Min | Typ | Max | Unit |
|--|-----------|-----|-----|-----|------------------|
| DETECTOR ($I_F = 0$ unless otherwise noted) | | | | | |
| Peak Blocking Current, Either Direction (Rated V_{DRM} , Note 1) | I_{DRM} | — | 10 | 100 | nA |
| Peak On-State Voltage, Either Direction ($I_{TM} = 100 \text{ mA Peak}$) | V_{TM} | — | 2.5 | 3 | Volts |
| Critical Rate of Rise of Off-State Voltage, Figure 3, Note 2 | dv/dt | — | 10 | — | V/ μs |

OPTICAL

| | | | | | |
|--|----------|---|-----|---|--------------------|
| Maximum Irradiance Level Required to Latch Output (Main Terminal Voltage 3 V, $R_L = 150 \Omega$) Color Temperature = 2870K | H_{TH} | — | 2 | 5 | mW/cm ² |
| Holding Current, Either Direction Initiating Flux Density = 5 mW/cm ² | I_H | — | 100 | — | μA |

Notes: 1. Test voltage must be applied within dv/dt rating.

2. This is static dv/dt . See Figure 6 for test circuit. Commutating dv/dt is a function of the load-driving thyristor(s) only.

TYPICAL CHARACTERISTICS

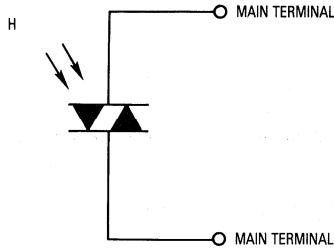

Figure 1. Typical Operating Circuit

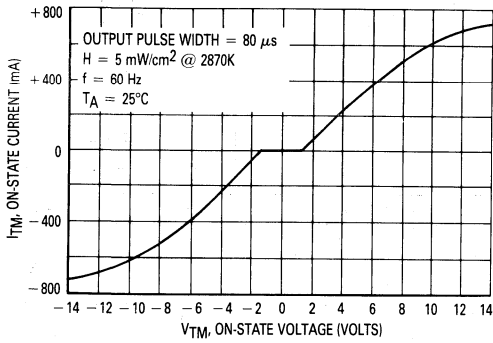

Figure 2. On-State Characteristics

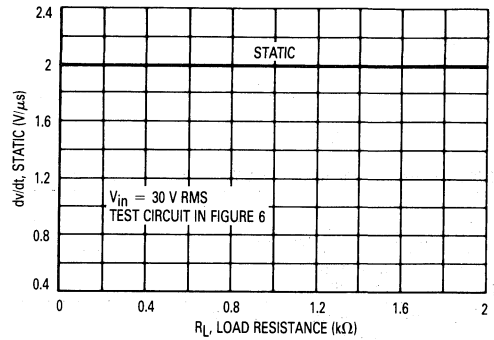

Figure 3. dv/dt versus Load Resistance

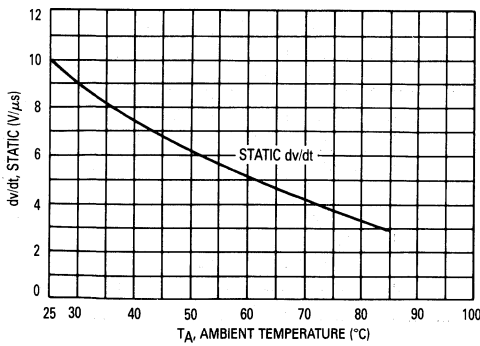

Figure 4. dv/dt versus Temperature

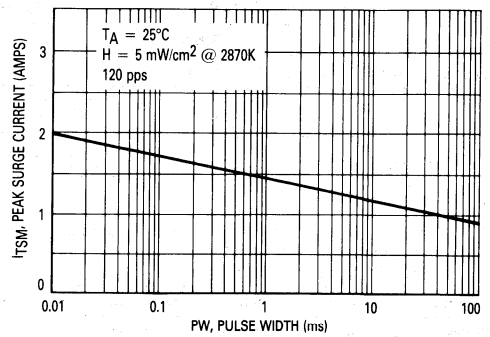

Figure 5. Maximum Repetitive Surge Current

Note: This device should not be used to drive a load directly. It is intended to be a trigger device only.

MRD3010

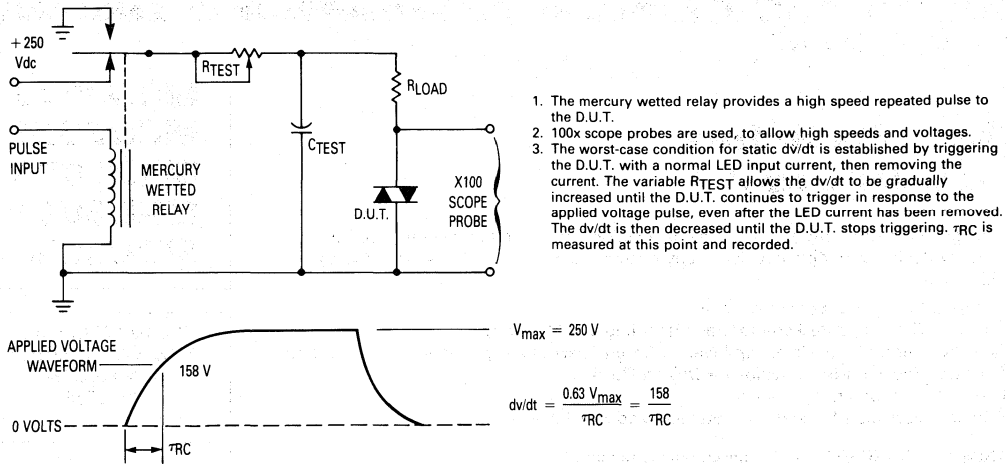

Figure 6. Static dv/dt Test Circuit

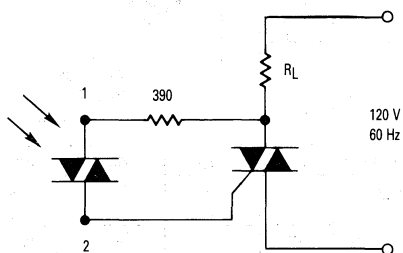

Figure 7. Resistive Load

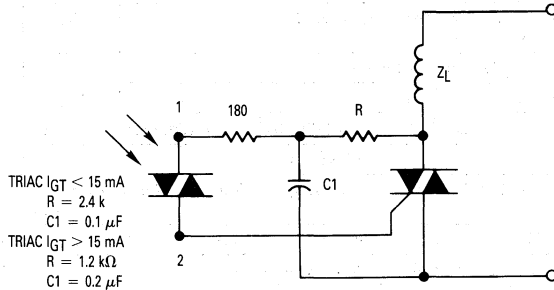

Figure 8. Inductive Load

OUTLINE DIMENSIONS

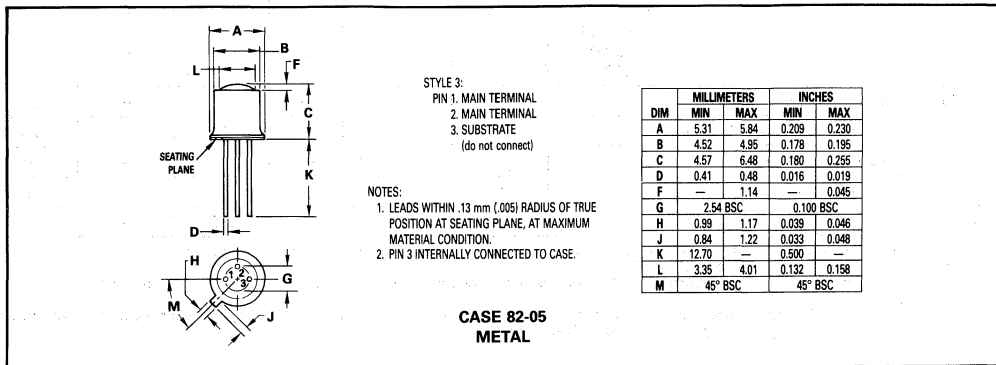

Photo Detectors

Transistor Output

... designed for application in industrial inspection, processing and control, counters, sorters, switching and logic circuits or any design requiring radiation sensitivity, and stable characteristics.

- Hermetic Package at Economy Prices
- Popular TO-18 Type Package for Easy Handling and Mounting
- Sensitive Throughout Visible and Near Infrared Spectral Range for Wider Application
- Range of Radiation Sensitivities for Design Flexibility
- External Base for Added Control
- Annular Passivated Structure for Stability and Reliability

MAXIMUM RATINGS ($T_A = 25^\circ\text{C}$ unless otherwise noted)

| Rating | Symbol | Value | Unit |
|---|-----------|-------------|----------------------------|
| Collector-Emitter Voltage | V_{CEO} | 30 | Volts |
| Emitter-Collector Voltage | V_{ECO} | 5 | Volts |
| Collector-Base Voltage | V_{CBO} | 40 | Volts |
| Total Power Dissipation ($@ T_A = 25^\circ\text{C}$ Derate above 25°C) | P_D | 250 2.27 | mW mW/ $^\circ\text{C}$ |
| Operating Temperature Range | T_A | -55 to +125 | $^\circ\text{C}$ |
| Storage Temperature Range | T_{stg} | -65 to +150 | $^\circ\text{C}$ |

STATIC ELECTRICAL CHARACTERISTICS ($T_A = 25^\circ\text{C}$ unless otherwise noted)

| Characteristic | Symbol | Min | Typ | Max | Unit |
|--|---------------|--------|--------|----------|---------------|
| Collector Dark Current ($V_{CC} = 20\text{ V}$, $R_L = 1\text{ Megohm}$, Note 2) $T_A = 25^\circ\text{C}$ $T_A = 85^\circ\text{C}$ | I_{CEO} | — — | — 5 | 0.1 — | μA |
| Collector-Base Breakdown Voltage ($I_C = 100\ \mu\text{A}$) | $V_{(BR)CBO}$ | 40 | — | — | Volts |
| Collector-Emitter Breakdown Voltage ($I_C = 100\ \mu\text{A}$) | $V_{(BR)CEO}$ | 30 | — | — | Volts |
| Emitter-Collector Breakdown Voltage ($I_E = 100\ \mu\text{A}$) | $V_{(BR)ECO}$ | 5 | — | — | Volts |

OPTICAL CHARACTERISTICS ($T_A = 25^\circ\text{C}$ unless otherwise noted)

| Characteristic | Fig. No. | Symbol | Min | Typ | Max | Unit |
|---|----------|-------------------|-------------------------------|-----------------------|-----------------------|---------------|
| Collector-Light Current ($V_{CC} = 20\text{ V}$, $R_L = 100\text{ Ohms}$, Note 1) | 1 | I_L | 0.1 0.2 0.5 1.5 2 | — — — — — | — — — — — | mA |
| Photo Current Saturated Rise Time (Note 3) | 5 | $t_r(\text{sat})$ | — | 1 | — | μs |
| Photo Current Saturated Fall Time (Note 3) | 5 | $t_f(\text{sat})$ | — | 10 | — | μs |
| Photo Current Rise Time (Note 4) | 5 | t_r | — | 2 | — | μs |
| Photo Current Fall Time (Note 4) | 5 | t_f | — | 3.5 | — | μs |
| Wavelength of Maximum Sensitivity | — | λ_s | — | 0.8 | — | μm |

- NOTES: 1. Radiation flux density (H) equal to 5 mW/cm^2 emitted from a tungsten source at a color temperature of 2870 K.
 2. Measured under dark conditions. ($H = 0$).
 3. For saturated switching time measurements, radiation is provided by a pulsed xenon arc lamp with a pulse width of approximately 1 microsecond (see Figure 5).
 4. For unsaturated switching time measurements, radiation is provided by a pulsed GaAs (gallium-arsenide) light-emitting diode ($\lambda = 940\text{ nm}$) with a pulse width equal to or greater than 10 microseconds (see Figure 5).

MRD3050
MRD3051
MRD3054
MRD3055
MRD3056

PHOTO DETECTORS
TRANSISTOR OUTPUT
NPN SILICON
30 VOLTS

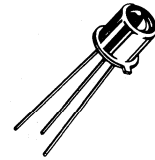

CASE 82-05
METAL

4

MRD3050, MRD3051, MRD3054, MRD3055, MRD3056

TYPICAL CHARACTERISTICS

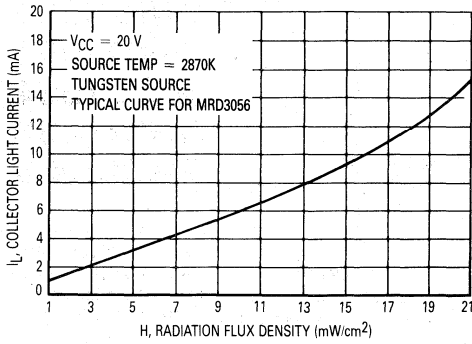

Figure 1. Collector Light Current

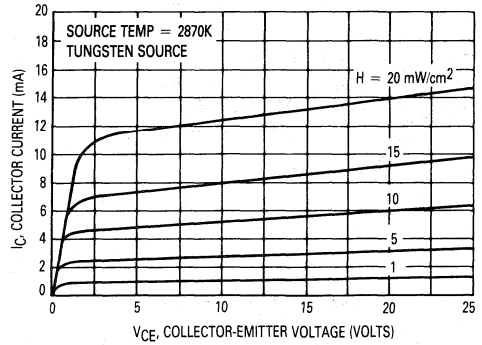

Figure 2. Collector Emitter Characteristics — MRD3056

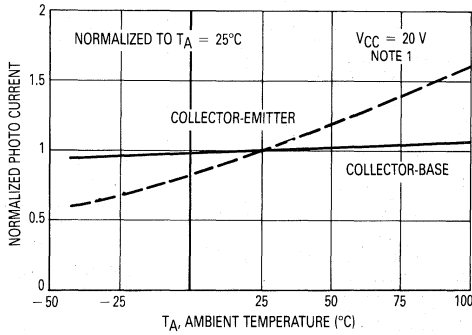

Figure 3. Photo Current versus Temperature

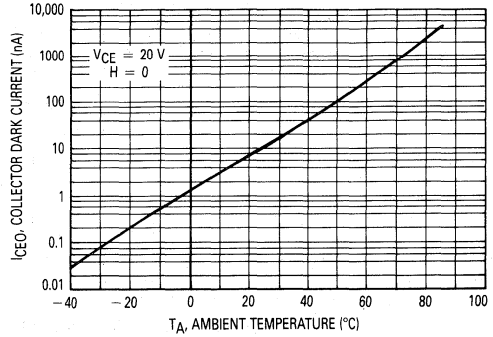

Figure 4. Dark Current versus Temperature

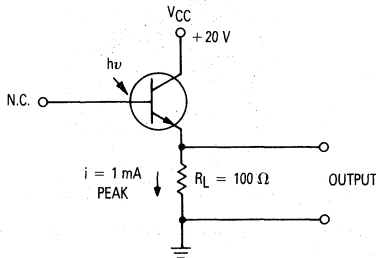

Figure 5. Pulse Response Test Circuit and Waveform

4

MRD3050, MRD3051, MRD3054, MRD3055, MRD3056

TYPICAL CIRCUIT APPLICATIONS

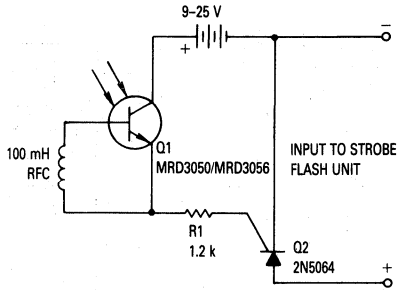

Figure 6. Strobeflash Slave Adapter

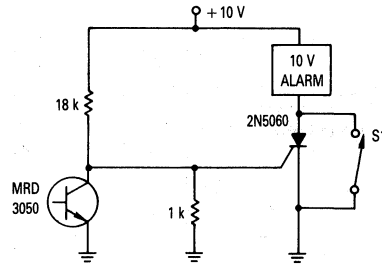

Figure 7. Light Operated SCR Alarm Using Sensitive-Gate SCR

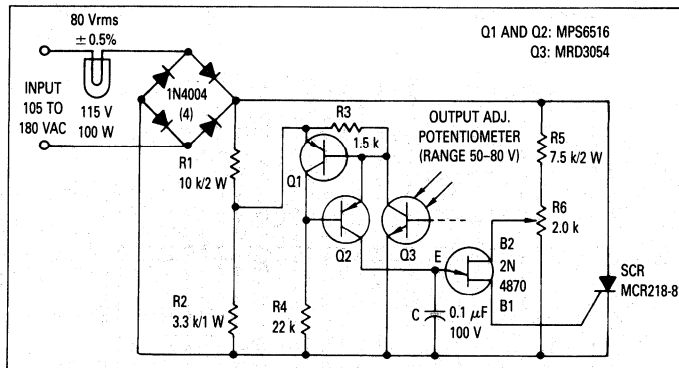
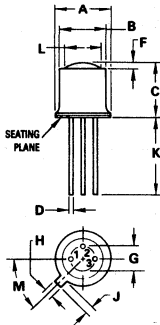

Figure 8. Circuit Diagram of Voltage Regulator for Projection Lamp

*MCR218-8 to be used with a heat sink.

4

OUTLINE DIMENSIONS



- NOTES:
- LEADS WITHIN .13 mm (.005) RADIUS OF TRUE POSITION AT SEATING PLANE, AT MAXIMUM MATERIAL CONDITION.
 - PIN 3 INTERNALLY CONNECTED TO CASE.

STYLE 1:
PIN 1. EMITTER
2. BASE
3. COLLECTOR

CASE 82-05
METAL

| DIM | MILLIMETERS | | INCHES | |
|-----|-------------|------|-----------|-------|
| | MIN | MAX | MIN | MAX |
| A | 5.31 | 5.84 | 0.209 | 0.230 |
| B | 4.52 | 4.95 | 0.178 | 0.195 |
| C | 4.57 | 6.48 | 0.180 | 0.255 |
| D | 0.41 | 0.48 | 0.016 | 0.019 |
| F | — | 1.14 | — | 0.045 |
| G | 2.54 BSC | | 0.100 BSC | |
| H | 0.99 | 1.17 | 0.039 | 0.046 |
| J | 0.84 | 1.22 | 0.033 | 0.048 |
| K | 12.70 | — | 0.500 | — |
| L | 3.35 | 4.01 | 0.132 | 0.158 |
| M | 45° BSC | | 45° BSC | |

Photo Detector Logic Output

... incorporates a Schmitt Trigger which provides hysteresis for noise immunity and pulse shaping. The detector circuit is optimized for simplicity of operation and utilizes an open-collector output for application flexibility.

- Popular TO-18 Type Package for Easy Handling and Mounting
- High Coupling Efficiency
- Wide V_{CC} Range
- Ideally Suited for Use With MLED930 Emitter
- Usable to 125 kHz
- Hermetic Metal Package for Maximum Stability and Reliability

MRD5009

**PHOTO DETECTOR
 LOGIC OUTPUT**



CASE 82-05

4

MAXIMUM RATINGS ($T_A = 25^\circ\text{C}$ unless otherwise noted)

| Rating | Symbol | Value | Unit |
|---|-----------|-------------|----------------------------|
| Output Voltage Range | V_O | 0-16 | Volts |
| Supply Voltage Range | V_{CC} | 0-16 | Volts |
| Output Current | I_O | 50 | mA |
| Device Dissipation Derate above 25°C^* | P_D | 250 2.27 | mW mW/ $^\circ\text{C}$ |
| Maximum Operating Temperature | T_A | -40 to +85 | $^\circ\text{C}$ |
| Storage Temperature Range | T_{stg} | -65 to +200 | $^\circ\text{C}$ |
| Lead Soldering Temperature (10 seconds maximum) | T_L | 260 | $^\circ\text{C}$ |

| Characteristic | Symbol | Min | Typ | Max | Unit |
|----------------|--------|-----|-----|-----|------|
|----------------|--------|-----|-----|-----|------|

DEVICE CHARACTERISTICS ($T_A = 25^\circ\text{C}$)

| | | | | | |
|--|----------------------|---|---|-----|---------------|
| Operating Voltage | V_{CC} | 3 | — | 15 | Volts |
| Supply Current with Output High, Figure 4 ($I_F = 0, V_{CC} = 5\text{ V}$) | $I_{CC}(\text{off})$ | — | 1 | 5 | mA |
| Output Current, High ($I_F = 0, V_{CC} = V_O = 15\text{ V}, R_L = 270\ \Omega$) | I_{OH} | — | — | 100 | μA |

(continued)

MRD5009

| Characteristic | Symbol | Min | Typ | Max | Unit |
|---|------------|-----|------|-----|-------------------------|
| COUPLED CHARACTERISTICS ($T_A = 0-70^\circ\text{C}$) | | | | | |
| Light Required to Trigger (Tungsten Source, 2870 K) | $H_{(on)}$ | — | 0.50 | — | mW/cm^2 |

The following characteristics are measured with an MLED930 emitter at a separation distance of 8 mm (0.315 inches) with the lenses of the emitter and detector on a common axis within 0.1 mm and parallel within 5 degrees.

| | | | | | |
|--|--------------------------------|---|------|-----|-------|
| Supply Current with Output Low, Figure 5 ($I_F = I_{F(on)}$, $V_{CC} = 5\text{ V}$) | $I_{CC(on)}$ | — | 1.6 | 5 | mA |
| Output Voltage, Low ($R_L = 270\ \Omega$, $V_{CC} = 5\text{ V}$, $I_F = I_{F(on)}$) | V_{OL} | — | 0.2 | 0.4 | volts |
| Threshold Current, ON ($R_L = 270\ \Omega$, $V_{CC} = 5\text{ V}$) | $I_{F(on)}$ | — | 10 | 20 | mA |
| Threshold Current, OFF ($R_L = 270\ \Omega$, $V_{CC} = 5\text{ V}$) | $I_{F(off)}$ | 1 | 7.5 | — | mA |
| Hysteresis Ratio, Figure 1 ($R_L = 270\ \Omega$, $V_{CC} = 5\text{ V}$) | $\frac{I_{F(off)}}{I_{F(on)}}$ | — | 0.75 | — | |

SWITCHING CHARACTERISTICS ($T_A = 25^\circ\text{C}$)

| | | | | | | |
|---------------|---|-----------|---|-----|---|---------------|
| Turn-On Time | $R_L = 270\ \Omega$, $V_{CC} = 5\text{ V}$, $I_F = I_{F(on)}$ | t_{on} | — | 1.2 | 5 | μs |
| Fall Time | | t_f | — | 0.1 | — | |
| Turn-Off Time | | t_{off} | — | 1.2 | 5 | |
| Rise Time | | t_r | — | 0.1 | — | |

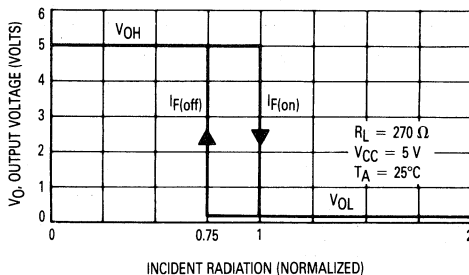

Figure 1. Transfer Characteristics

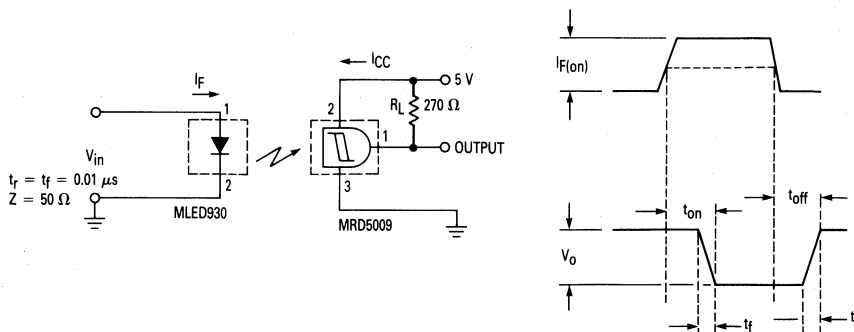

Figure 2. Switching Test Circuit

MRD5009

TYPICAL CHARACTERISTICS

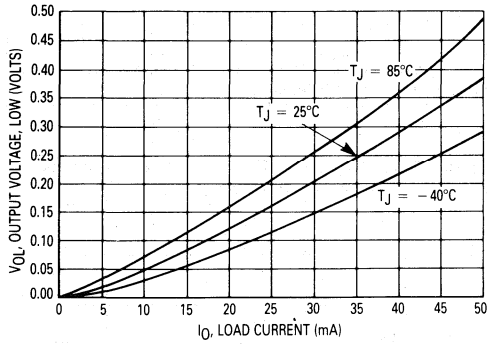

Figure 3. Output Voltage, Low versus Load Current

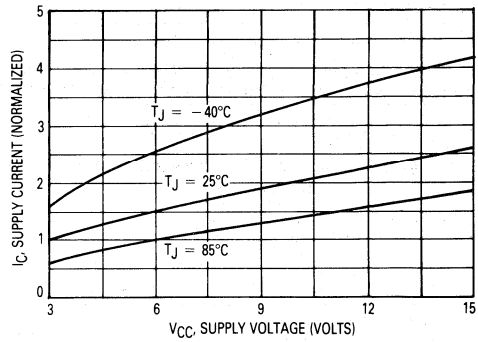

Figure 4. Supply Current versus Supply Voltage — Output High

TYPICAL COUPLED CHARACTERISTICS USING MLED930 EMITTER AND MRD5009 DIGITAL OUTPUT DETECTOR

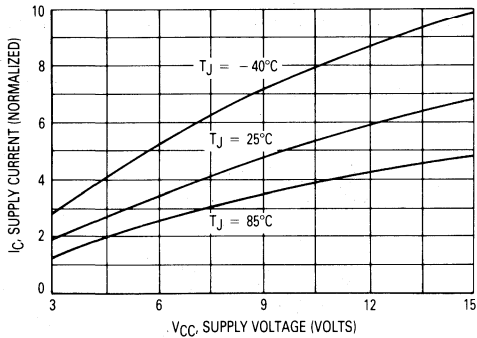

Figure 5. Supply Current versus Supply Voltage — Output Low

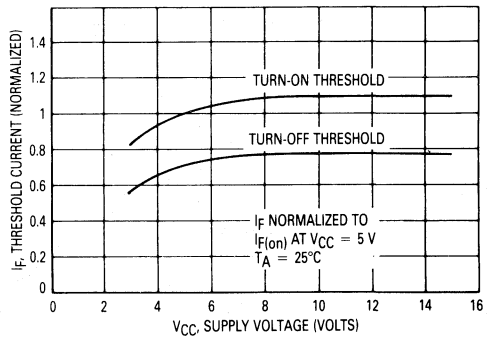

Figure 6. Threshold Current versus Supply Voltage

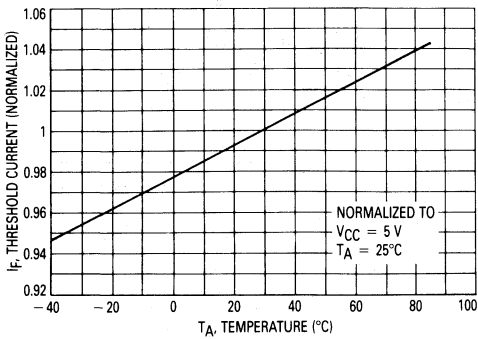

Figure 7. Threshold Current versus Temperature

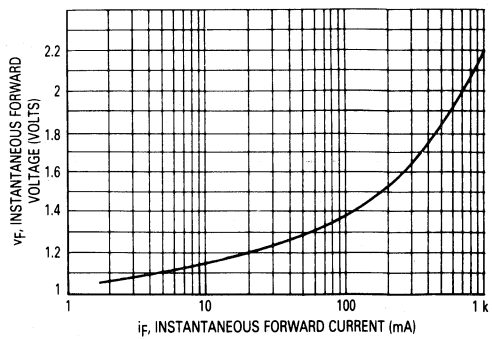

Figure 8. MLED930 Forward Characteristics

4

MRD5009

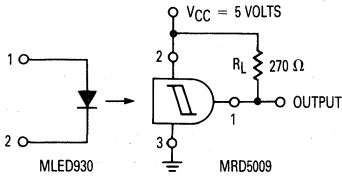

Figure 9. Test Circuit for Threshold Current Measurements

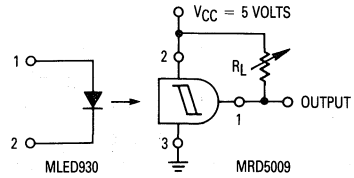

Figure 10. Test Circuit for Output Voltage versus Load Current Measurements

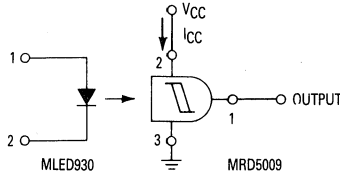
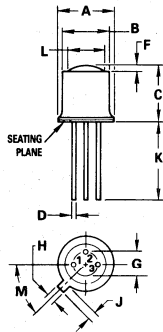

Figure 11. Test Circuit for Supply Current versus Supply Voltage Measurements



- NOTES:
- LEADS WITHIN .13 mm (.005) RADIUS OF TRUE POSITION AT SEATING PLANE, AT MAXIMUM MATERIAL CONDITION.
 - PIN 3 INTERNALLY CONNECTED TO CASE.

STYLE 4:
PIN 1. OUTPUT
2. VCC
3. GROUND

| DIM | MILLIMETERS | | INCHES | |
|-----|-------------|------|-----------|-------|
| | MIN | MAX | MIN | MAX |
| A | 5.31 | 5.84 | 0.209 | 0.230 |
| B | 4.52 | 4.95 | 0.178 | 0.195 |
| C | 4.57 | 6.48 | 0.180 | 0.255 |
| D | 0.41 | 0.48 | 0.016 | 0.019 |
| F | — | 1.14 | — | 0.045 |
| G | 2.64 BSC | | 0.100 BSC | |
| H | 0.99 | 1.17 | 0.039 | 0.046 |
| J | 0.84 | 1.22 | 0.033 | 0.048 |
| K | 12.70 | — | 0.500 | — |
| L | 3.35 | 4.01 | 0.132 | 0.158 |
| M | 45° BSC | | 45° BSC | |

CASE 82-05

Fiber Optics Components Data Sheets

5

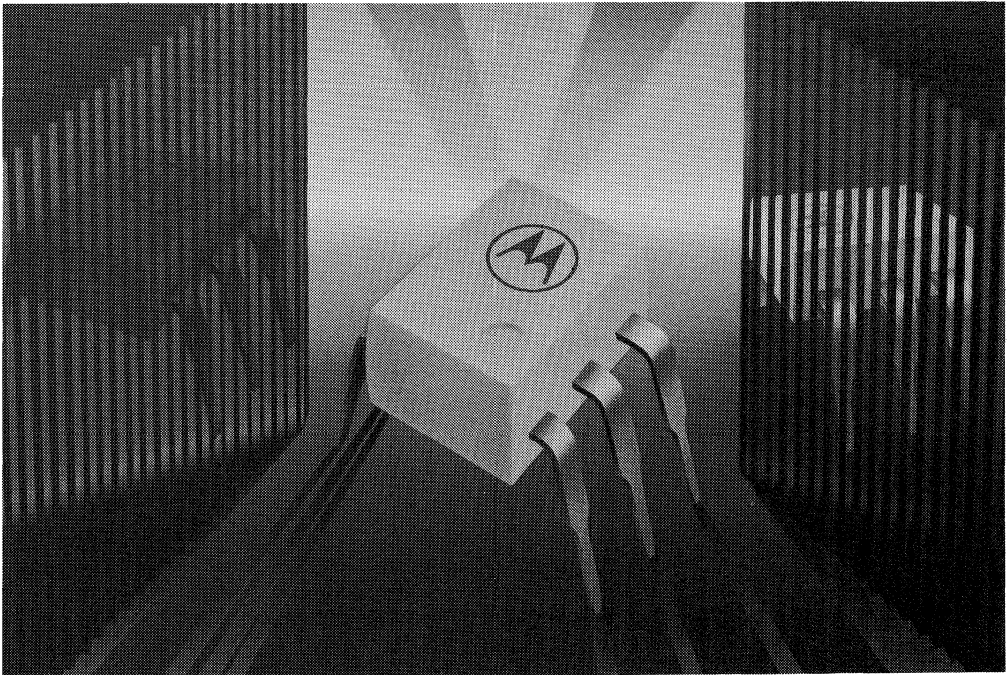

Fiber Optics — FLCS Family

Photo Detector

Diode Output

... designed for low cost, short distance Fiber Optic Systems using 1000 micron core plastic fiber.

Typical applications include: high isolation interconnects, disposable medical electronics, consumer products, and microprocessor controlled systems such as coin operated machines, copy machines, electronic games, industrial clothes dryers, etc.

- Fast PIN Photodiode: Response Time <5 ns
- Ideally Matched to MFOE76 Emitter for Plastic Fiber Systems
- Annular Passivated Structure for Stability and Reliability
- FLCS Package
 - Includes Connector
 - Simple Fiber Termination and Connection (Figure 4)
 - Easy Board Mounting
 - Molded Lens for Efficient Coupling
 - Mates with 1000 Micron Core Plastic Fiber (Eska SH4001)

MFOD71

**FLCS FAMILY
 FIBER OPTICS
 PHOTO DETECTOR
 DIODE OUTPUT**

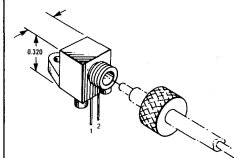

**CASE 363B-01
 PLASTIC**

MAXIMUM RATINGS ($T_A = 25^\circ\text{C}$ unless otherwise noted)

| Rating | Symbol | Value | Unit |
|---|-----------------|-------------|----------------------------|
| Reverse Voltage | MFOD71 V_R | 100 | Volts |
| Total Power Dissipation @ $T_A = 25^\circ\text{C}$ Derate above 25°C | P_D | 150 2 | mW mW/ $^\circ\text{C}$ |
| Operating and Storage Junction Temperature Range | T_J, T_{stg} | -40 to +100 | $^\circ\text{C}$ |

ELECTRICAL CHARACTERISTICS ($T_A = 25^\circ\text{C}$ unless otherwise noted)

| Characteristic | Symbol | Min | Typ | Max | Unit |
|---|-------------|-----|------------|---------|-------|
| Dark Current ($V_R = 20\text{ V}, R_L = 1\text{ M}\Omega$) $T_A = 25^\circ\text{C}$ $T_A = 85^\circ\text{C}$ | I_D | — | 0.06 10 | 10 — | nA |
| Reverse Breakdown Voltage ($I_R = 10\ \mu\text{A}$) | $V_{(BR)R}$ | 50 | 100 | — | Volts |
| Forward Voltage ($I_F = 50\text{ mA}$) | V_F | — | — | 1.1 | Volts |
| Series Resistance ($I_F = 50\text{ mA}$) | R_s | — | 8 | — | Ohms |
| Total Capacitance ($V_R = 20\text{ V}, f = 1\text{ MHz}$) | C_T | — | 3 | — | pF |

OPTICAL CHARACTERISTICS ($T_A = 25^\circ\text{C}$)

| | | | | | |
|--|--------------|------|-----|---|---------------------------|
| Responsivity ($V_R = 5\text{ V}$, Figure 2) | R | 0.15 | 0.2 | — | $\mu\text{A}/\mu\text{W}$ |
| Response Time ($V_R = 5\text{ V}, R_L = 50\ \Omega$) | $t_{(resp)}$ | — | 5 | — | ns |

MFOD71

TYPICAL COUPLED CHARACTERISTICS

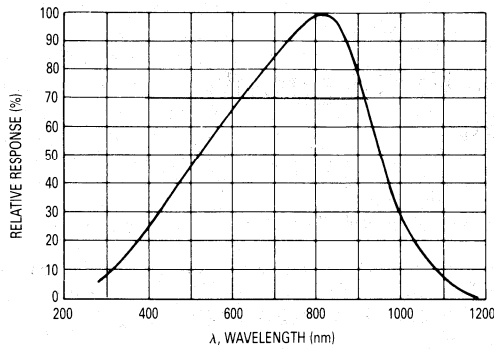

Figure 1. Relative Spectral Response

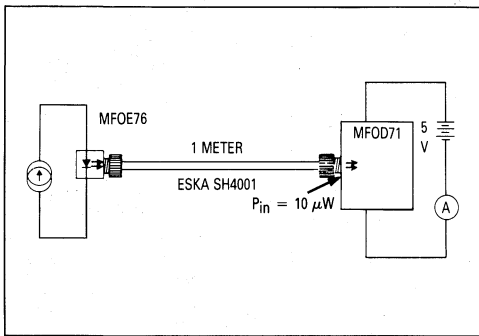

Figure 2. Responsivity Test Configuration

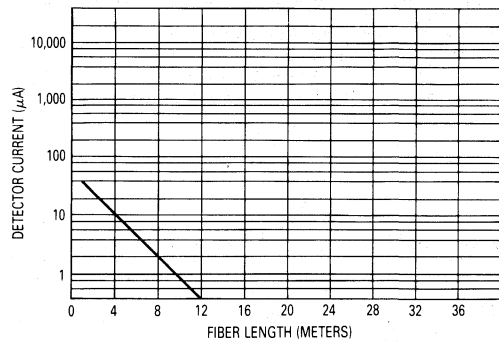

Figure 3. Detector Current versus Fiber Length

The system length achieved with a MFOE76 emitter and various detectors, using 1000 micron core plastic fiber (Eska SH4001 or equivalent), depends on the LED forward

current (I_F) and the responsivity of the detector chosen. Each detector will perform with the MFOE76 up to the distances shown below.

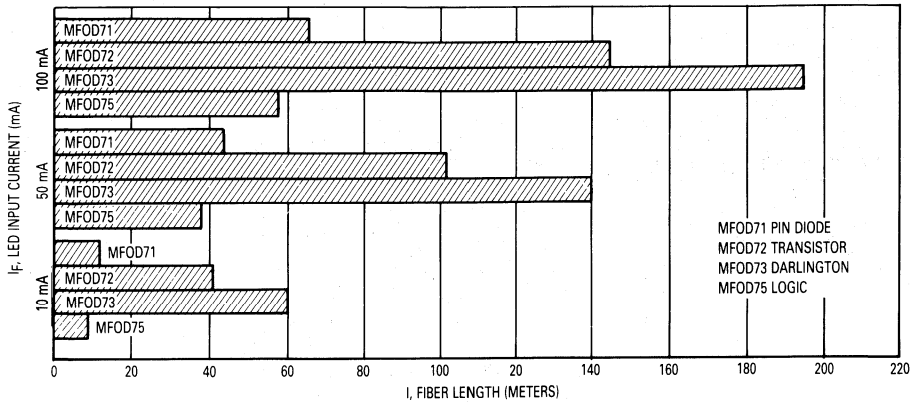

Figure 4. MFOE76 Working Distances

MFOD71

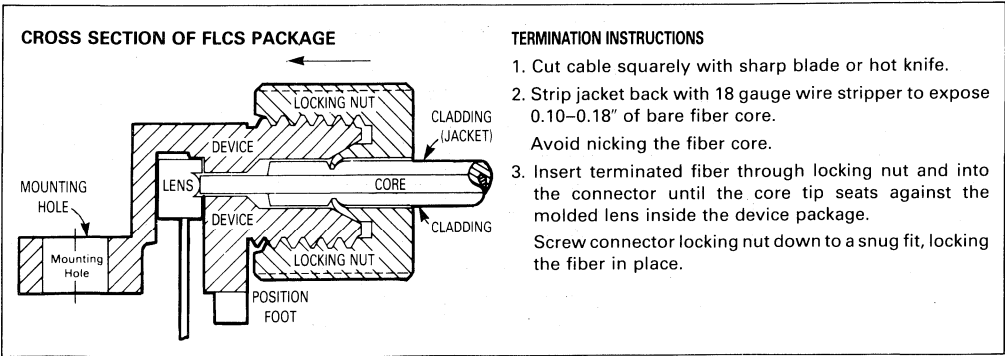

Figure 5. FO Cable Termination and Assembly

INPUT SIGNAL CONDITIONING

The following circuits are suggested to provide the desired forward current through the emitter.

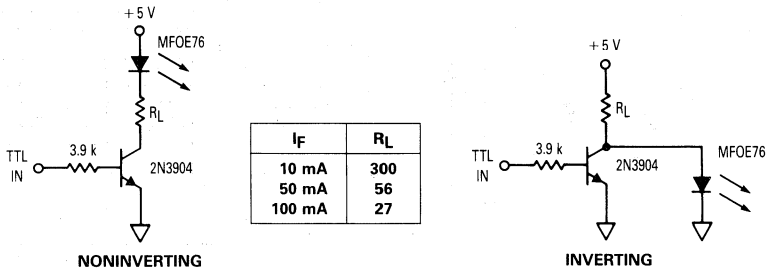

Figure 6. TTL Transmitters

OUTPUT SIGNAL CONDITIONING

The following circuit is suggested to take the MFOD71 detector output and condition it to drive TTL with an acceptable bit error rate.

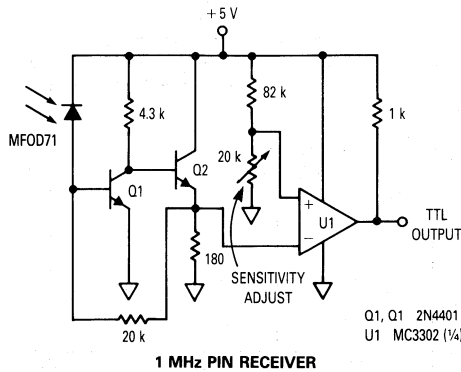
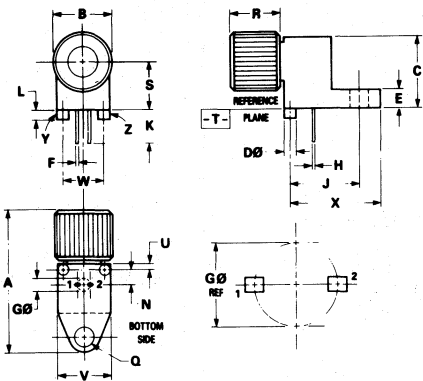

Figure 7. TTL Receiver

5

OUTLINE DIMENSIONS



- NOTES:
1. Y AND Z ARE DATUM DIMENSIONS AND T IS A DATUM SURFACE.
 2. POSITIONAL TOLERANCE FOR D \varnothing (2 PL):
 $\boxed{\text{M}} \varnothing 0.25 (0.010) \boxed{\text{T}} | \text{Y} \boxed{\text{M}} | \text{Z} \boxed{\text{M}}$
 3. POSITIONAL TOLERANCE FOR F DIMENSION (2 PL):
 $\boxed{\text{M}} 0.25 (0.010) \boxed{\text{M}} | \text{T} | \text{Y} \boxed{\text{M}} | \text{Z} \boxed{\text{M}}$
 4. POSITIONAL TOLERANCE FOR H DIMENSION (2 PL):
 $\boxed{\text{M}} 0.25 (0.010) \boxed{\text{M}} | \text{T} | \text{Y} \boxed{\text{M}} | \text{Z} \boxed{\text{M}}$
 5. POSITIONAL TOLERANCE FOR Q \varnothing :
 $\boxed{\text{M}} \varnothing 0.25 (0.010) \boxed{\text{M}} | \text{T} | \text{Y} \boxed{\text{M}} | \text{Z} \boxed{\text{M}}$
 6. POSITIONAL TOLERANCE FOR B
 $\boxed{\text{M}} \varnothing 0.25 (0.010) \boxed{\text{M}} | \text{T}$
 7. DIMENSIONING AND TOLERANCING PER ANSI Y14.5M, 1982.
 8. CONTROLLING DIMENSION: INCH.

STYLE 3:
 PIN 1. CATHODE
 2. ANODE

| DIM | MILLIMETERS | | INCHES | |
|-----|-------------|-------|-----------|-------|
| | MIN | MAX | MIN | MAX |
| A | 19.30 | 21.33 | 0.760 | 0.840 |
| B | 9.14 | 9.39 | 0.360 | 0.370 |
| C | 7.62 | 8.12 | 0.300 | 0.320 |
| D | 1.55 | 1.62 | 0.061 | 0.064 |
| E | 2.41 | 2.66 | 0.095 | 0.105 |
| F | 0.43 | 0.58 | 0.017 | 0.023 |
| G | 2.54 BSC | | 0.100 BSC | |
| H | 0.33 | 0.45 | 0.013 | 0.018 |
| J | 7.62 BSC | | 0.300 BSC | |
| K | 9.91 | 11.43 | 0.390 | 0.450 |
| L | 1.14 | 1.65 | 0.045 | 0.065 |
| N | 2.54 BSC | | 0.100 BSC | |
| Q | 3.05 | 3.30 | 0.120 | 0.130 |
| R | 7.62 | 8.12 | 0.300 | 0.320 |
| S | 5.08 BSC | | 0.200 BSC | |
| U | 0.66 | 0.91 | 0.026 | 0.036 |
| V | 6.86 | 7.11 | 0.270 | 0.280 |
| W | 5.08 BSC | | 0.200 BSC | |
| X | 10.87 | 11.55 | 0.428 | 0.455 |

CASE 363B-01
 PLASTIC

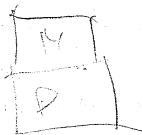

Fiber Optics — FLCS Family

Photo Detector

Transistor Output

MFOD72

**FLCS FAMILY
 FIBER OPTICS
 PHOTO DETECTOR
 TRANSISTOR OUTPUT**

... designed for low cost, short distance Fiber Optic Systems using 1000 micron core plastic fiber.

Typical applications include: high isolation interconnects, disposable medical electronics, consumer products, and microprocessor controlled systems such as coin operated machines, copy machines, electronic games, industrial clothes dryers, etc.

- Standard Phototransistor Output
- Ideally Matched to MFOE76 Emitter for Plastic Fiber Systems
- Annular Passivated Structure for Stability and Reliability
- FLCS Package
 - Includes Connector
 - Simple Fiber Termination and Connection (Figure 4)
 - Easy Board Mounting
 - Molded Lens for Efficient Coupling
 - Mates with 1000 Micron Core Plastic Fiber (Eska SH4001)

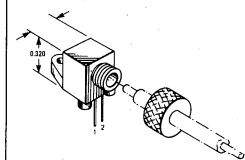

**CASE 363B-01
 PLASTIC**

MAXIMUM RATINGS ($T_A = 25^\circ\text{C}$ unless otherwise noted)

| Rating | Symbol | Value | Unit |
|--|----------------|-------------|----------------------------|
| Collector-Emitter Voltage | V_{CEO} | 30 | Volts |
| Total Power Dissipation ($\alpha T_A = 25^\circ\text{C}$ Derate above 25°C) | P_D | 150 2 | mW mW/ $^\circ\text{C}$ |
| Operating and Storage Junction Temperature Range | T_J, T_{stg} | -40 to +100 | $^\circ\text{C}$ |

ELECTRICAL CHARACTERISTICS ($T_A = 25^\circ\text{C}$ unless otherwise noted)

| Characteristic | Symbol | Min | Typ | Max | Unit |
|--|---------------|-----|-----|-----|-------|
| Collector Dark Current ($V_{CE} = 10\text{ V}$) | I_D | — | — | 100 | nA |
| Collector-Emitter Breakdown Voltage ($I_C = 10\text{ mA}$) | $V_{(BR)CEO}$ | 30 | — | — | Volts |

OPTICAL CHARACTERISTICS

| | | | | | |
|--|--|-----------|------|-----|---------------------------|
| Responsivity ($V_{CC} = 5\text{ V}$, Figure 2) | R | 80 | 125 | — | $\mu\text{A}/\mu\text{W}$ |
| Saturation Voltage ($\lambda = 850\text{ nm}$, $V_{CC} = 5\text{ V}$) ($P_{in} = 10\ \mu\text{W}$, $I_C = 1\text{ mA}$) | $V_{CE(sat)}$ | — | 0.25 | 0.4 | Volts |
| Turn-On Time | $R_L = 2.4\text{ k}\Omega$, $P_{in} = 10\ \mu\text{W}$, $\lambda = 850\text{ nm}$, $V_{CC} = 5\text{ V}$ | t_{on} | — | 10 | μs |
| Turn-Off Time | | t_{off} | — | 60 | μs |

MFOD72

TYPICAL COUPLED CHARACTERISTICS

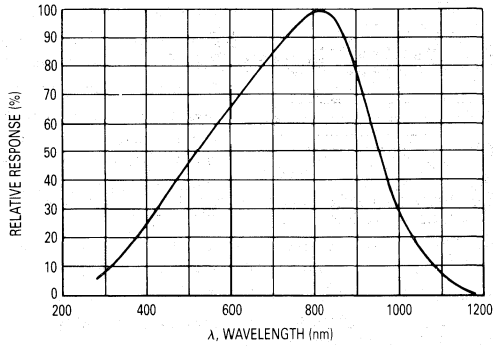

Figure 1. Relative Spectral Response

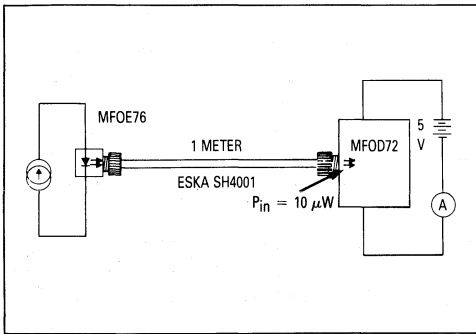

Figure 2. Responsivity Test Configuration

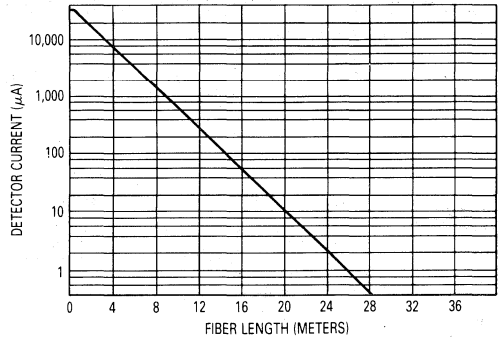

Figure 3. Detector Current versus Fiber Length

The system length achieved with a MFOE76 emitter and various detectors, using 1000 micron core plastic fiber (Eska SH4001 or equivalent), depends on the LED forward

current (I_f) and the responsivity of the detector chosen. Each detector will perform with the MFOE76 up to the distances shown below.

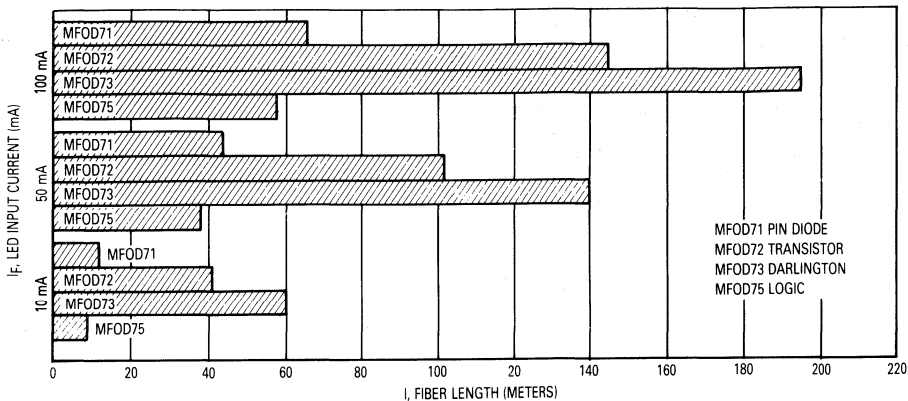

Figure 4. MFOE76 Working Distances

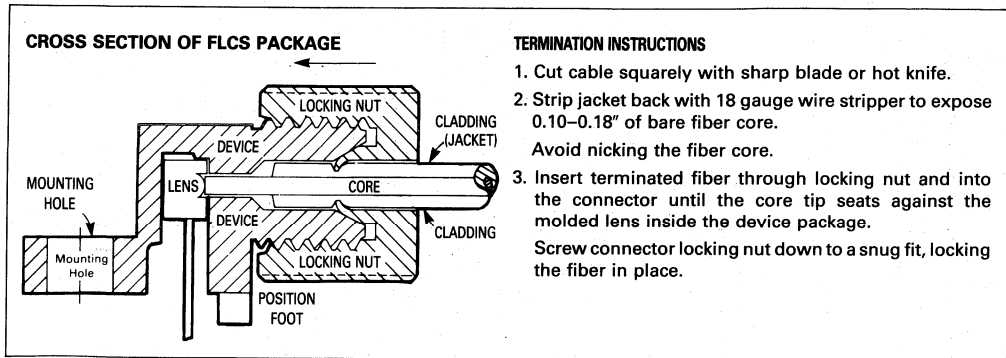

Figure 5. FO Cable Termination and Assembly

INPUT SIGNAL CONDITIONING

The following circuits are suggested to provide the desired forward current through the emitter.

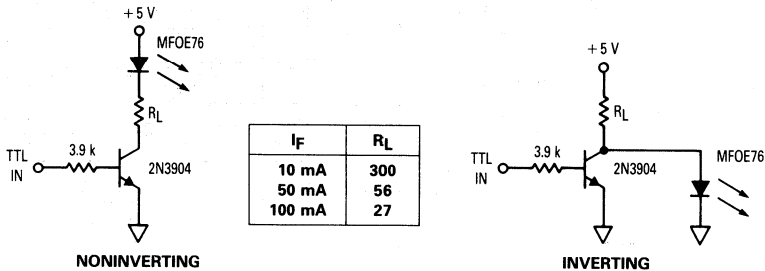

Figure 6. TTL Transmitters

OUTPUT SIGNAL CONDITIONING

The following circuit is suggested to take the MFOD72 detector output and condition it to drive TTL with an acceptable bit error rate.

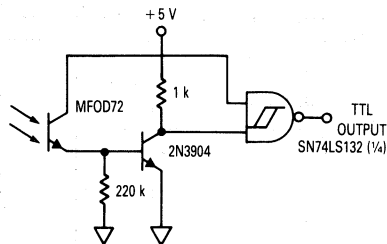
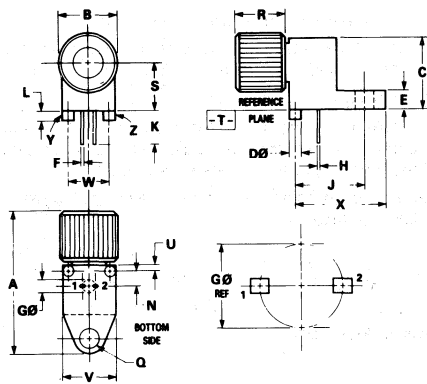

Figure 7. 5 kHz Transistor Receiver

5

MFOD72

OUTLINE DIMENSIONS



- NOTES:
1. Y AND Z ARE DATUM DIMENSIONS AND T IS A DATUM SURFACE.
 2. POSITIONAL TOLERANCE FOR D Ø (2 PL):
 $\left[\begin{array}{c} \phi 0.25 (0.010) \\ \text{M} \\ \text{T} | \text{Y} \\ \text{Z} \end{array} \right]$
 3. POSITIONAL TOLERANCE FOR F DIMENSION (2 PL):
 $\left[\begin{array}{c} \phi 0.25 (0.010) \\ \text{M} \\ \text{T} | \text{Y} \\ \text{Z} \end{array} \right]$
 4. POSITIONAL TOLERANCE FOR H DIMENSION (2 PL):
 $\left[\begin{array}{c} \phi 0.25 (0.010) \\ \text{M} \\ \text{T} | \text{Y} \\ \text{Z} \end{array} \right]$
 5. POSITIONAL TOLERANCE FOR Q Ø:
 $\left[\begin{array}{c} \phi 0.25 (0.010) \\ \text{M} \\ \text{T} | \text{Y} \\ \text{Z} \end{array} \right]$
 6. POSITIONAL TOLERANCE FOR B
 $\left[\begin{array}{c} \phi 0.25 (0.010) \\ \text{M} \\ \text{T} \end{array} \right]$
 7. DIMENSIONING AND TOLERANCING PER ANSI Y14.5M, 1982.
 8. CONTROLLING DIMENSION: INCH.

STYLE 3:
 PIN 1. CATHODE
 2. ANODE

| DIM | MILLIMETERS | | INCHES | |
|-----|-------------|-------|-----------|-------|
| | MIN | MAX | MIN | MAX |
| A | 19.30 | 21.33 | 0.760 | 0.840 |
| B | 9.14 | 9.39 | 0.360 | 0.370 |
| C | 7.62 | 8.12 | 0.300 | 0.320 |
| D | 1.55 | 1.62 | 0.061 | 0.064 |
| E | 2.41 | 2.66 | 0.095 | 0.105 |
| F | 0.43 | 0.58 | 0.017 | 0.023 |
| G | 2.54 BSC | | 0.100 BSC | |
| H | 0.33 | 0.45 | 0.013 | 0.018 |
| J | 7.62 BSC | | 0.300 BSC | |
| K | 9.91 | 11.43 | 0.390 | 0.450 |
| L | 1.14 | 1.65 | 0.045 | 0.065 |
| N | 2.54 BSC | | 0.100 BSC | |
| Q | 3.05 | 3.30 | 0.120 | 0.130 |
| R | 7.62 | 8.12 | 0.300 | 0.320 |
| S | 5.08 BSC | | 0.200 BSC | |
| U | 0.66 | 0.91 | 0.026 | 0.036 |
| V | 6.86 | 7.11 | 0.270 | 0.280 |
| W | 5.08 BSC | | 0.200 BSC | |
| X | 10.87 | 11.55 | 0.428 | 0.455 |

CASE 363B-01
PLASTIC

Fiber Optics — FLCS Family

Photo Detector

Darlington Output

MFOD73

... designed for low cost, short distance Fiber Optic Systems using 1000 micron core plastic fiber.

Typical applications include: high isolation interconnects, disposable medical electronics, consumer products, and microprocessor controlled systems such as coin operated machines, copy machines, electronic games, industrial clothes dryers, etc.

- High Sensitivity Photodarlington Output
- Ideally Matched to MFOE76 Emitter for Plastic Fiber Systems
- Annular Passivated Structure for Stability and Reliability
- FLCS Package
 - Includes Connector
 - Simple Fiber Termination and Connection (Figure 4)
 - Easy Board Mounting
 - Molded Lens for Efficient Coupling
 - Mates with 1000 Micron Core Plastic Fiber (Eska SH4001)

FLCS FAMILY
FIBER OPTICS
PHOTO DETECTOR
DARLINGTON OUTPUT

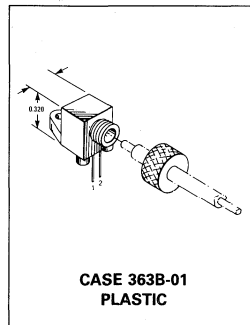

MAXIMUM RATINGS ($T_A = 25^\circ\text{C}$ unless otherwise noted)

| Rating | Symbol | Value | Unit |
|---|----------------|-------------|----------------------------|
| Collector-Emitter Voltage | V_{CE0} | 60 | Volts |
| Total Power Dissipation @ $T_A = 25^\circ\text{C}$ Derate above 25°C | P_D | 150 2 | mW mW/ $^\circ\text{C}$ |
| Operating and Storage Junction Temperature Range | T_J, T_{stg} | -40 to +100 | $^\circ\text{C}$ |

ELECTRICAL CHARACTERISTICS ($T_A = 25^\circ\text{C}$ unless otherwise noted)

| Characteristic | Symbol | Min | Typ | Max | Unit |
|--|---------------|-----|-----|-----|-------|
| Collector Dark Current ($V_{CE} = 10\text{ V}$) | I_D | — | — | 100 | nA |
| Collector-Emitter Breakdown Voltage ($I_C = 10\text{ mA}$) | $V_{(BR)CEO}$ | 60 | — | — | Volts |

OPTICAL CHARACTERISTICS

| | | | | | |
|---|--|-----------|-------|-----|---------------------------|
| Responsivity ($V_{CC} = 5\text{ V}$, Figure 2) | R | 1,000 | 1,500 | — | $\mu\text{A}/\mu\text{W}$ |
| Saturation Voltage ($\lambda = 850\text{ nm}$, $V_{CC} = 5\text{ V}$) ($P_{in} = 1\ \mu\text{W}$, $I_C = 2\text{ mA}$) | $V_{CE(sat)}$ | — | 0.75 | 1 | Volts |
| Turn-On Time | $R_L = 100\ \Omega$, $P_{in} = 1\ \mu\text{W}$, $\lambda = 850\text{ nm}$, $V_{CC} = 5\text{ V}$ | t_{on} | — | 125 | μs |
| Turn-Off Time | | t_{off} | — | 150 | μs |

5

MFOD73

TYPICAL COUPLED CHARACTERISTICS

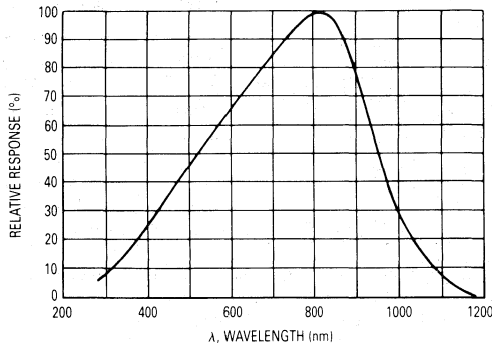

Figure 1. Relative Spectral Response

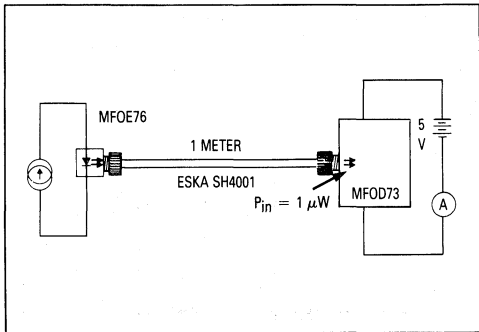

Figure 2. Responsivity Test Configuration

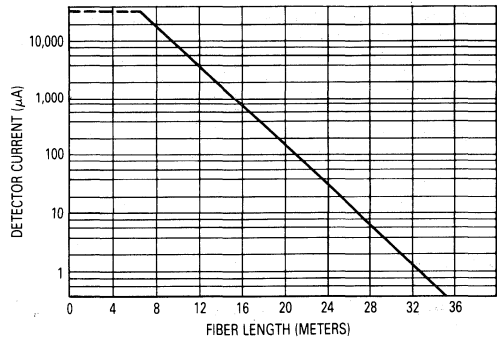

Figure 3. Detector Current versus Fiber Length

The system length achieved with a MFOE76 emitter and various detectors, using 1000 micron core plastic fiber (Eska SH4001 or equivalent), depends on the LED forward

current (I_f) and the responsivity of the detector chosen. Each detector will perform with the MFOE76 up to the distances shown below.

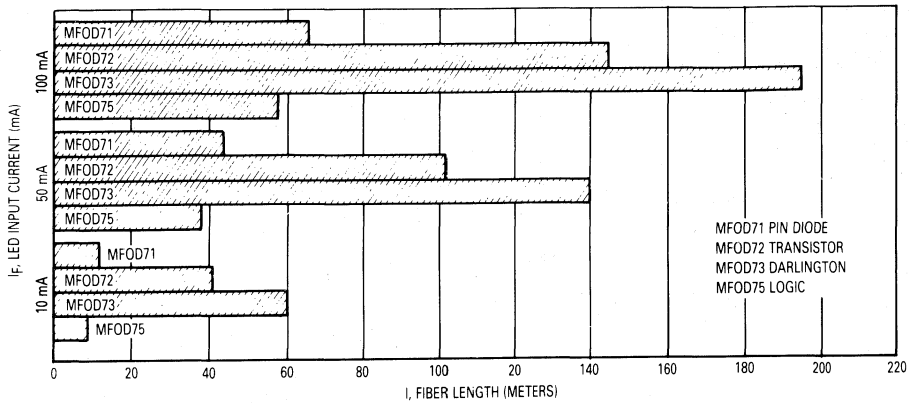

Figure 4. MFOE76 Working Distances

MFOD73

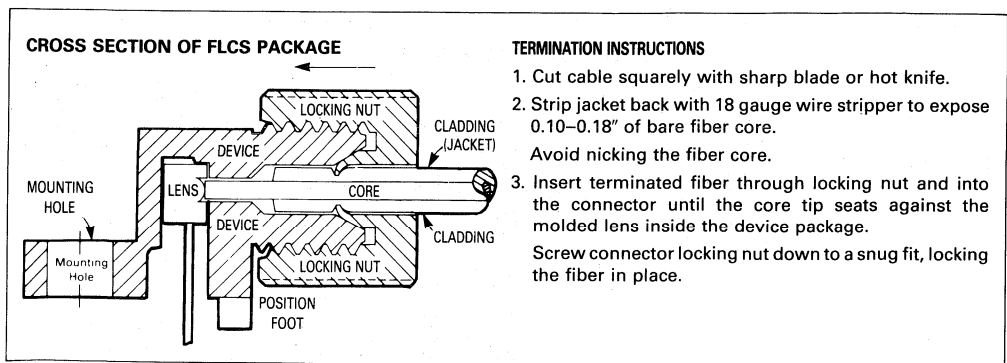

Figure 5. FO Cable Termination and Assembly

INPUT SIGNAL CONDITIONING

The following circuits are suggested to provide the desired forward current through the emitter.

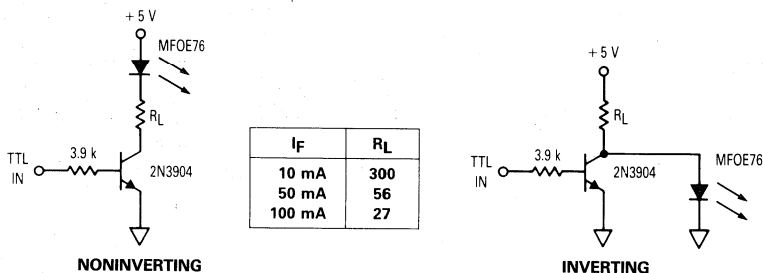

Figure 6. TTL Transmitters

OUTPUT SIGNAL CONDITIONING

The following circuit is suggested to take the FLCS detector output and condition it to drive TTL with an acceptable bit error rate.

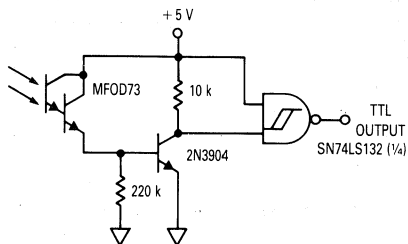
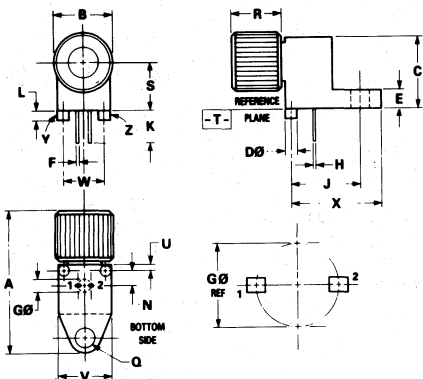

Figure 7. 1 kHz Darlington Receiver

5

MFOD73

OUTLINE DIMENSIONS



NOTES:

1. Y AND Z ARE DATUM DIMENSIONS AND T IS A DATUM SURFACE.
2. POSITIONAL TOLERANCE FOR D \varnothing (2 PL):
 $\left[\begin{array}{c} \pm \phi 0.25 (0.010) \\ \text{M} \end{array} \right] \left[\begin{array}{c} \text{T} \\ \text{Y} \end{array} \right] \left[\begin{array}{c} \text{M} \\ \text{Z} \end{array} \right]$
3. POSITIONAL TOLERANCE FOR F DIMENSION (2 PL):
 $\left[\begin{array}{c} \pm 0.25 (0.010) \\ \text{M} \end{array} \right] \left[\begin{array}{c} \text{T} \\ \text{Y} \end{array} \right] \left[\begin{array}{c} \text{M} \\ \text{Z} \end{array} \right]$
4. POSITIONAL TOLERANCE FOR H DIMENSION (2 PL):
 $\left[\begin{array}{c} \pm 0.25 (0.010) \\ \text{M} \end{array} \right] \left[\begin{array}{c} \text{T} \\ \text{Y} \end{array} \right] \left[\begin{array}{c} \text{M} \\ \text{Z} \end{array} \right]$
5. POSITIONAL TOLERANCE FOR Q \varnothing :
 $\left[\begin{array}{c} \pm \phi 0.25 (0.010) \\ \text{M} \end{array} \right] \left[\begin{array}{c} \text{T} \\ \text{Y} \end{array} \right] \left[\begin{array}{c} \text{M} \\ \text{Z} \end{array} \right]$
6. POSITIONAL TOLERANCE FOR B
 $\left[\begin{array}{c} \pm \phi 0.25 (0.010) \\ \text{M} \end{array} \right] \left[\begin{array}{c} \text{T} \end{array} \right]$
7. DIMENSIONING AND TOLERANCING PER ANSI Y14.5M, 1982.
8. CONTROLLING DIMENSION: INCH.

STYLE 3:
 PIN 1, CATHODE
 2, ANODE

| DIM | MILLIMETERS | | INCHES | |
|-----|-------------|-------|-----------|-------|
| | MIN | MAX | MIN | MAX |
| A | 19.30 | 21.33 | 0.760 | 0.840 |
| B | 9.14 | 9.39 | 0.360 | 0.370 |
| C | 7.62 | 8.12 | 0.300 | 0.320 |
| D | 1.55 | 1.62 | 0.061 | 0.064 |
| E | 2.41 | 2.66 | 0.095 | 0.105 |
| F | 0.43 | 0.58 | 0.017 | 0.023 |
| G | 2.54 BSC | | 0.100 BSC | |
| H | 0.33 | 0.45 | 0.013 | 0.018 |
| J | 7.62 BSC | | 0.300 BSC | |
| K | 9.91 | 11.43 | 0.390 | 0.450 |
| L | 1.14 | 1.65 | 0.045 | 0.065 |
| N | 2.54 BSC | | 0.100 BSC | |
| Q | 3.05 | 3.30 | 0.120 | 0.130 |
| R | 7.62 | 8.12 | 0.300 | 0.320 |
| S | 5.08 BSC | | 0.200 BSC | |
| U | 0.66 | 0.91 | 0.026 | 0.036 |
| V | 6.86 | 7.11 | 0.270 | 0.280 |
| W | 5.08 BSC | | 0.200 BSC | |
| X | 10.87 | 11.55 | 0.428 | 0.455 |

CASE 363B-01
PLASTIC

Fiber Optics — FLCS Family

Photo Detector

Logic Output

MFOD75

**FLCS FAMILY
 FIBER OPTICS
 PHOTO DETECTOR
 LOGIC OUTPUT**

... designed for low cost, short distance (<60 m) fiber optics systems using 1000 micron (1 mm) plastic core fiber.

Typical applications include mainframe-to-terminal interconnects, consumer products, industrial controls and other systems requiring low cost transmission of digital information.

- Ideally Matched to MFOE76 Emitter For Plastic Fiber Systems
- Connector Included
- Simple Fiber Termination and Connection (Figure 12)
- Easy Board Mounting
- Molded Lens for Efficient Coupling
- Designed for 1000 Micron Core Plastic Fiber, Such As:
 Eska SH4001

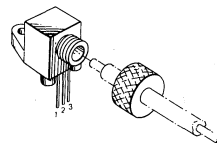

**CASE 363C-01
 PLASTIC**

MAXIMUM RATINGS ($T_A = 25^\circ\text{C}$ unless otherwise noted)

| Rating | Symbol | Value | Unit |
|---|-----------------------|-------------|----------------------------|
| Supply Voltage Range | V_{CC} | 3-16 | Volts |
| Output Current | I_o | 50 | mA |
| Power Dissipation* Derate above 25°C | P_D ΔP_D | 150 2 | mW mW/ $^\circ\text{C}$ |
| Operating and Junction Temperature Range | T_A, T_J | -40 to +85 | $^\circ\text{C}$ |
| Storage Temperature Range | T_{stg} | -40 to +100 | $^\circ\text{C}$ |
| Soldering Temperature (5 seconds) | — | 260 | $^\circ\text{C}$ |

DEVICE CHARACTERISTICS ($T_A = 25^\circ\text{C}$)

| Characteristic | Symbol | Min | Typ | Max | Unit |
|---|------------------------------|-----|------|-----|---------------|
| Supply Current with Output High ($I_F = 0, V_{CC} = 5\text{ V}$) | $I_{CC(off)}$ | — | 1.3 | 5 | mA |
| Output Current with Output High ($I_F = 0, V_{CC} = 15\text{ V}, R_L = 270\ \Omega$) | I_{OH} | — | — | 100 | nA |
| Supply Current with Output Low ($I_F = I_{F(on)}, V_{CC} = 5\text{ V}$) | $I_{CC(on)}$ | — | 3 | 5 | mA |
| Output Voltage, Low ($I_F = I_{F(on)}, V_{CC} = 5\text{ V}, R_L = 270\ \Omega$) | V_{OL} | — | 0.14 | 0.4 | Volts |
| Light Required to Trigger ($V_{CC} = 5\text{ V}, R_L = 270\ \Omega, \lambda = 850\text{ nm}$) | $H_{(on)}$ | — | 6 | 10 | μW |
| Hysteresis Ratio ($V_{CC} = 5\text{ V}, R_L = 270\ \Omega$) | $\frac{H_{(on)}}{H_{(off)}}$ | — | 0.75 | — | — |
| Turn-On Time | t_{on} | — | 0.4 | 2 | μs |
| Fall Time | t_f | — | 20 | — | ns |
| Turn-Off Time | t_{off} | — | 0.8 | 2 | μs |
| Rise Time | t_r | — | 40 | — | ns |

$V_{CC} = 5\text{ V}, R_L = 270\ \Omega,$
 $H = 20\ \mu\text{W},$ Figure 2,
 @ 850 nm

*Measured with device soldered into typical printed circuit board.

5

MFOD75

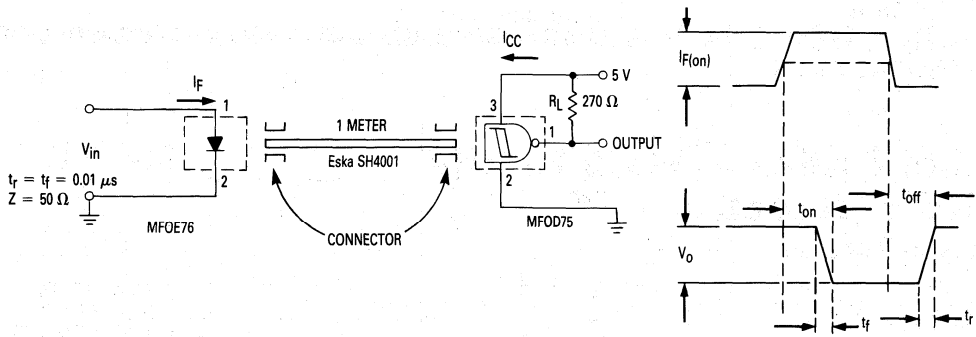

Figure 1. Switching Test Circuit

TYPICAL CHARACTERISTICS

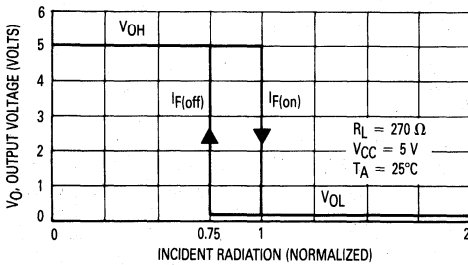

Figure 2. Transfer Characteristics

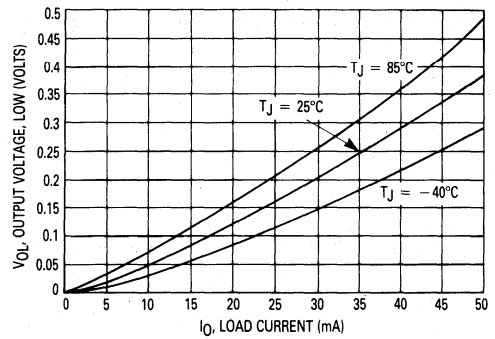

Figure 3. Output Voltage, Low versus Load Current

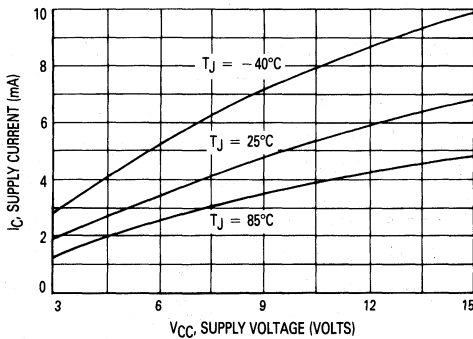

Figure 4. Supply Current versus Supply Voltage — Output Low

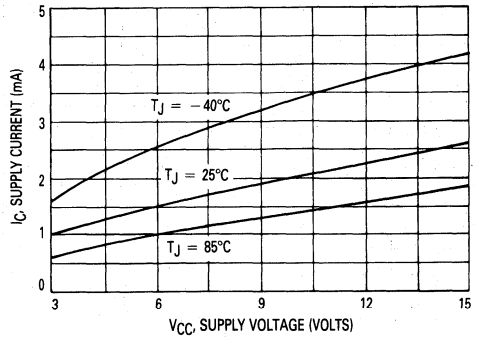

Figure 5. Supply Current versus Supply Voltage — Output High

5

TYPICAL CHARACTERISTICS

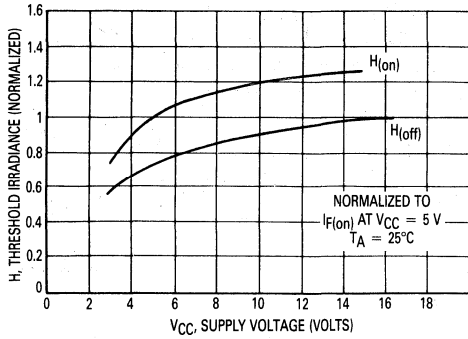

Figure 6. Threshold Irradiance versus Supply Voltage

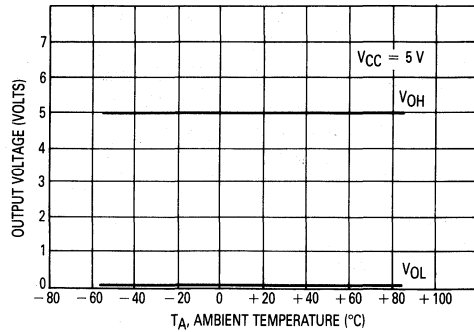

Figure 7. Output Voltage versus Ambient Temperature

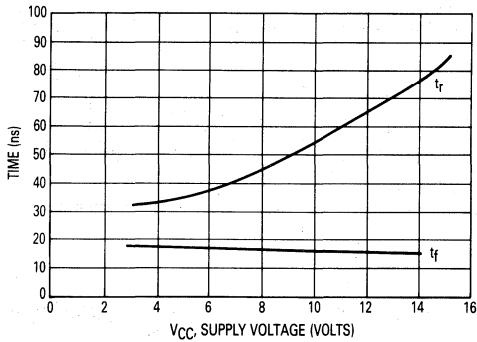

Figure 8. Pulse Response Time versus Supply Voltage

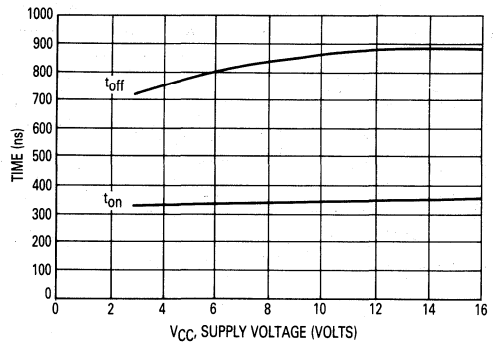
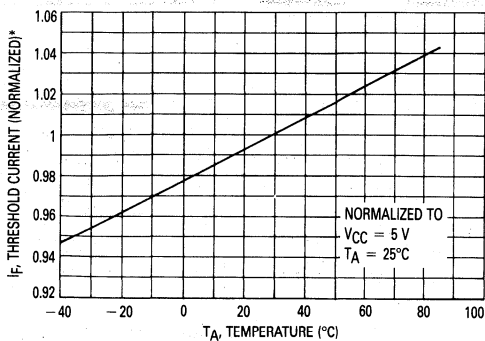

Figure 9. Total Switching Time versus Supply Voltage

Typical Coupled Characteristics Using MFOE71 and 1 Meter 1000 μm Plastic Cable



(*Temperature effects on plastic cable not included)

Figure 10. Threshold Current versus Temperature

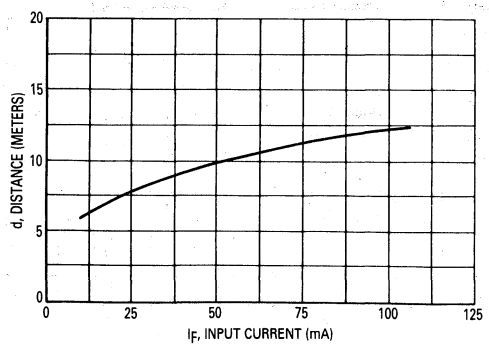
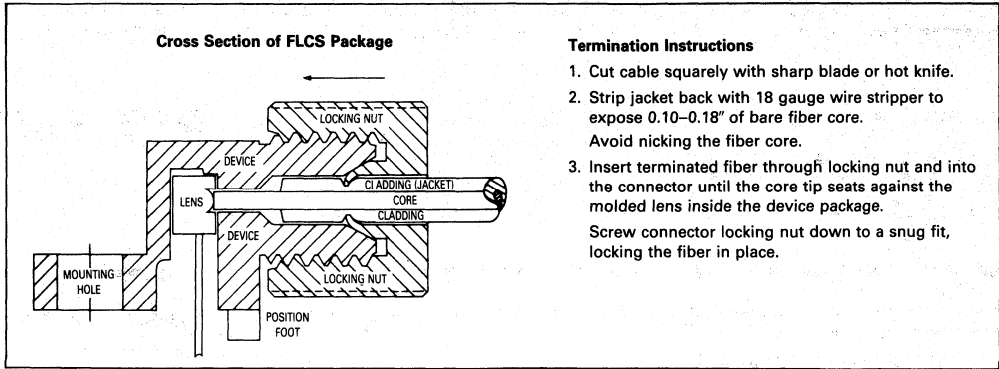

Figure 11. Working Distance versus Input Current

5

MFOD75



Termination Instructions

1. Cut cable squarely with sharp blade or hot knife.
2. Strip jacket back with 18 gauge wire stripper to expose 0.10–0.18" of bare fiber core.
Avoid nicking the fiber core.
3. Insert terminated fiber through locking nut and into the connector until the core tip seats against the molded lens inside the device package.
Screw connector locking nut down to a snug fit, locking the fiber in place.

Figure 12. FO Cable Termination and Assembly

OUTLINE DIMENSIONS

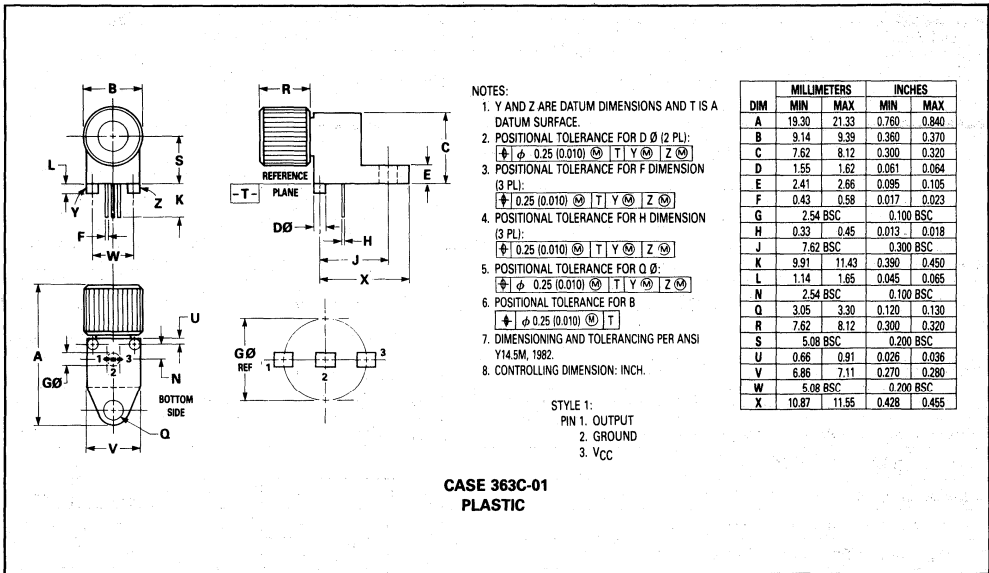

CASE 363C-01
PLASTIC

5

Fiber Optics
Photo Detector
Transistor Output

... designed for infrared radiation detection in medium length, medium frequency Fiber Optics Systems.

Typical applications include: medical electronics, industrial controls, security systems, M6800 Microprocessor Systems, etc.

- Spectral Response Matched to MFOE200
- Hermetic Metal Package for Stability and Reliability
- High Sensitivity for Medium Length Fiber Optics Control Systems
- Compatible with AMP Mounting Bushing #227015

MAXIMUM RATINGS ($T_A = 25^\circ\text{C}$ unless otherwise noted)

| Rating | Symbol | Value | Unit |
|--|-----------|-------------|----------------------------|
| Collector-Emitter Voltage | V_{CEO} | 40 | Volts |
| Emitter-Base Voltage | V_{EBO} | 10 | Volts |
| Collector-Base Voltage | V_{CBO} | 70 | Volts |
| Light Current | I_L | 250 | mA |
| Total Device Dissipation @ $T_A = 25^\circ\text{C}$ Derate above 25°C | P_D | 250 2.27 | mW mW/ $^\circ\text{C}$ |
| Operating Temperature Range | T_A | -55 to +125 | $^\circ\text{C}$ |
| Storage Temperature Range | T_{stg} | -65 to +150 | $^\circ\text{C}$ |

STATIC ELECTRICAL CHARACTERISTICS ($T_A = 25^\circ\text{C}$)

| Characteristic | Symbol | Min | Typ | Max | Unit |
|--|---------------|--------|--------|---------|---------------------|
| Collector Dark Current ($V_{CE} = 20\text{ V}$, $I_C = 0$) $T_A = 25^\circ\text{C}$ $T_A = 100^\circ\text{C}$ | I_{CEO} | — — | — 4 | 25 — | nA μA |
| Collector-Base Breakdown Voltage ($I_C = 100\ \mu\text{A}$) | $V_{(BR)CBO}$ | 50 | — | — | Volts |
| Collector-Emitter Breakdown Voltage ($I_C = 100\ \mu\text{A}$) | $V_{(BR)CEO}$ | 30 | — | — | Volts |
| Emitter-Collector Breakdown Voltage ($I_E = 100\ \mu\text{A}$) | $V_{(BR)ECO}$ | 7 | — | — | Volts |

OPTICAL CHARACTERISTICS ($T_A = 25^\circ\text{C}$)

| Characteristic | Symbol | Min | Typ | Max | Unit |
|--|--------|------|-----|-----|---------------------------|
| Responsivity (Figure 2) | R | 14.5 | 18 | — | $\mu\text{A}/\mu\text{W}$ |
| Photo Current Rise Time, Note 1 ($R_L = 100\ \text{ohms}$) | t_r | — | 2.5 | — | μs |
| Photo Current Fall Time, Note 1 ($R_L = 100\ \text{ohms}$) | t_f | — | 4 | — | μs |

Note 1. For unsaturated response time measurements, radiation is provided by pulsed GaAs (gallium-arsenide) light-emitting diode ($\lambda = 940\ \text{nm}$) with a pulse width equal to or greater than 10 microseconds, $I_C = 1\ \text{mA}$ peak.

MFOD200

HERMETIC FAMILY
FIBER OPTICS
PHOTO DETECTOR
TRANSISTOR OUTPUT

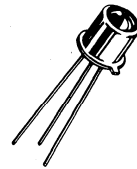

CASE 82-05
METAL

MFOD200

TYPICAL CHARACTERISTICS

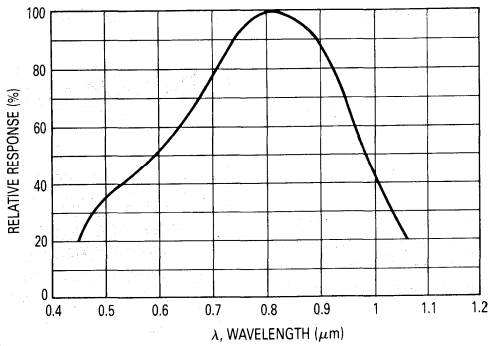

Figure 1. Constant Energy Spectral Response

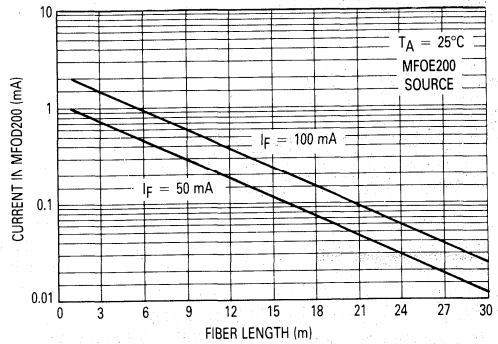

Figure 2. Coupled System Performance versus Fiber Length*

*0.045" Dia. Fiber Bundle, N.A. \cong 0.67, Attenuation at 940 nm \cong 0.6 dB/m

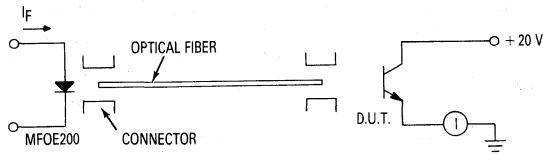
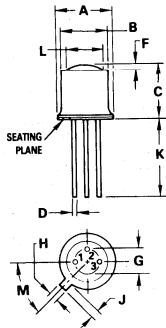

Figure 3. Responsivity Test Configuration

5

OUTLINE DIMENSIONS



- NOTES:
 1. LEADS WITHIN .13 mm (.005) RADIUS OF TRUE POSITION AT SEATING PLANE, AT MAXIMUM MATERIAL CONDITION.
 2. PIN 3 INTERNALLY CONNECTED TO CASE.

- STYLE 1:
 PIN 1. EMITTER
 2. BASE
 3. COLLECTOR

CASE 82-05
 METAL

| DIM | MILLIMETERS | | INCHES | |
|-----|-------------|------|-----------|-------|
| | MIN | MAX | MIN | MAX |
| A | 5.31 | 5.84 | 0.209 | 0.230 |
| B | 4.52 | 4.95 | 0.178 | 0.195 |
| C | 4.57 | 6.48 | 0.180 | 0.255 |
| D | 0.41 | 0.48 | 0.016 | 0.019 |
| F | — | 1.14 | — | 0.045 |
| G | 2.54 BSC | | 0.100 BSC | |
| H | 0.99 | 1.17 | 0.039 | 0.046 |
| J | 0.84 | 1.22 | 0.033 | 0.048 |
| K | 12.70 | — | 0.500 | — |
| L | 3.35 | 4.01 | 0.132 | 0.158 |
| M | 45° BSC | | 45° BSC | |

Fiber Optics
Photo Detector
Darlington Output

... designed for infrared radiation detection in long length, low frequency Fiber Optics Systems.

Typical applications include: industrial controls, security systems, medical electronics, M6800 Microprocessor Systems, etc.

- Spectral Response Matched to MFOE200
- Hermetic Metal Package for Stability and Reliability
- Very High Sensitivity for Long Length Fiber Optics Control Systems
- Compatible with AMP Mounting Bushing #227015

MAXIMUM RATINGS ($T_A = 25^\circ\text{C}$ unless otherwise noted)

| Rating | Symbol | Value | Unit |
|--|-----------|-------------|----------------------------|
| Collector-Emitter Voltage | V_{CEO} | 40 | Volts |
| Emitter-Base Voltage | V_{EBO} | 10 | Volts |
| Collector-Base Voltage | V_{CBO} | 70 | Volts |
| Light Current | I_L | 250 | mA |
| Total Device Dissipation @ $T_A = 25^\circ\text{C}$ Derate above 25°C | P_D | 250 2.27 | mW mW/ $^\circ\text{C}$ |
| Operating Temperature Range | T_A | -55 to +125 | $^\circ\text{C}$ |
| Storage Temperature Range | T_{stg} | -65 to +150 | $^\circ\text{C}$ |

STATIC ELECTRICAL CHARACTERISTICS ($T_A = 25^\circ\text{C}$)

| Characteristic | Symbol | Min | Typ | Max | Unit |
|---|---------------|-----|-----|-----|-------|
| Collector Dark Current ($V_{CE} = 10\text{ V}, H = 0$) | I_{CEO} | — | 10 | 100 | nA |
| Collector-Base Breakdown Voltage ($I_C = 100\ \mu\text{A}$) | $V_{(BR)CBO}$ | 50 | — | — | Volts |
| Collector-Emitter Breakdown Voltage ($I_C = 10\ \text{mA}$) | $V_{(BR)CEO}$ | 40 | — | — | Volts |
| Emitter-Base Breakdown Voltage ($I_E = 100\ \mu\text{A}$) | $V_{(BR)EBO}$ | 10 | — | — | Volts |

OPTICAL CHARACTERISTICS ($T_A = 25^\circ\text{C}$)

| Characteristic | Symbol | 400 | 500 | — | $\mu\text{A}/\mu\text{W}$ |
|--|--------|-----|-----|---|---------------------------|
| Responsivity (Figure 2) | R | 400 | 500 | — | $\mu\text{A}/\mu\text{W}$ |
| Photo Current Rise Time (Note 1) ($R_L = 100\ \text{ohms}$) | t_r | — | 40 | — | μs |
| Photo Current Fall Time (Note 1) ($R_L = 100\ \text{ohms}$) | t_f | — | 60 | — | μs |

Note 1. For unsaturated response time measurements, radiation is provided by pulsed GaAs (gallium-arsenide) light-emitting diode ($\lambda = 940\ \text{nm}$) with a pulse width equal to or greater than 500 microseconds, $I_C = 1\ \text{mA}$ peak.

MFOD300

HERMETIC FAMILY
FIBER OPTICS
PHOTO DETECTOR
DARLINGTON OUTPUT

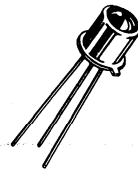

CASE 82-05
METAL

MFOD300

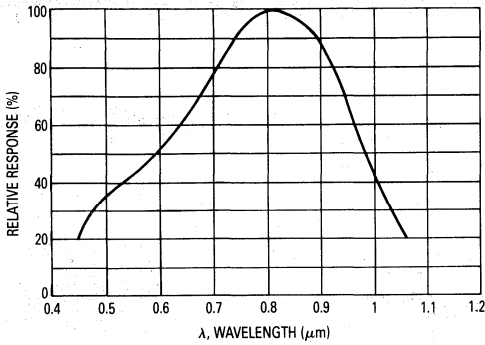

Figure 1. Constant Energy Spectral Response

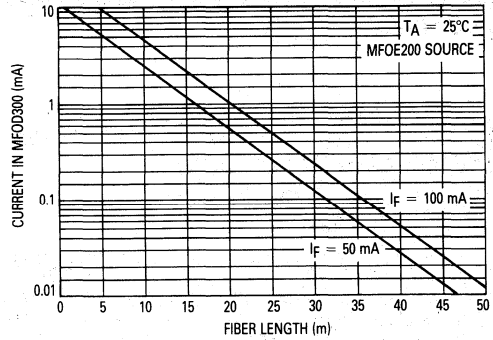

Figure 2. Coupled System Performance versus Fiber Length

*0.045" Dia. Fiber Bundle, N.A. \cong 0.67,
Attenuation at 940 nm \cong 0.6 dB/m

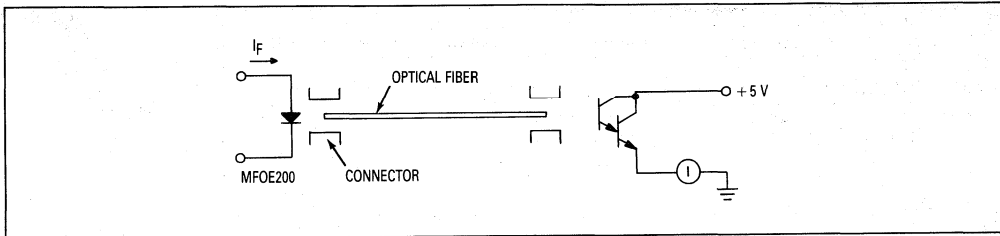
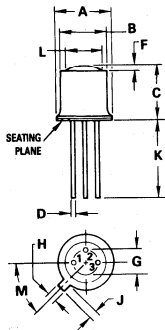

Figure 3. Responsivity Test Configuration

OUTLINE DIMENSIONS



NOTES:

- LEADS WITHIN .13 mm (.005) RADIUS OF TRUE POSITION AT SEATING PLANE, AT MAXIMUM MATERIAL CONDITION.
- PIN 3 INTERNALLY CONNECTED TO CASE.

STYLE 1:
PIN 1. EMITTER
2. BASE
3. COLLECTOR

| DIM | MILLIMETERS | | INCHES | |
|-----|-------------|------|-----------|-------|
| | MIN | MAX | MIN | MAX |
| A | 5.31 | 5.84 | 0.209 | 0.230 |
| B | 4.52 | 4.95 | 0.178 | 0.195 |
| C | 4.57 | 6.48 | 0.180 | 0.255 |
| D | 0.41 | 0.48 | 0.016 | 0.019 |
| F | — | 1.14 | — | 0.045 |
| G | 2.54 BSC | | 0.100 BSC | |
| H | 0.99 | 1.17 | 0.039 | 0.046 |
| J | 0.84 | 1.22 | 0.033 | 0.048 |
| K | 12.70 | — | 0.500 | — |
| L | 3.35 | 4.01 | 0.132 | 0.158 |
| M | 45° BSC | | 45° BSC | |

CASE 82-05
METAL

Fiber Optics — High Performance Family
Photo Detector
Diode Output

... designed for infrared radiation detection in high frequency Fiber Optics Systems. It is packaged in Motorola's hermetic TO-206AC (TO-52) case, and it fits directly into standard fiber optics connectors. The metal connectors provide excellent RFI immunity. Major applications are: CATV, video systems, M68000 microprocessor systems, industrial controls, computer and peripheral equipment, etc.

- Fast Response — 1 ns Max @ 5 Volts
- Analog Bandwidth (–3 dB) Greater Than 250 MHz
- Performance Matched to Motorola Fiber Optics Emitters
- TO-206AC (TO-52) Package — Small, Rugged, and Hermetic
- Compatible with AMP #228756-1, Amphenol #905-138-5001 and Radiall #F086600380 Receptacles Using Motorola Plastic Alignment Bushing MF0A06 (Included)

MAXIMUM RATINGS ($T_A = 25^\circ\text{C}$ unless otherwise noted)

| Rating | Symbol | Value | Unit |
|--|-----------|-------------|----------------------------|
| Reverse Voltage | V_R | 50 | Volts |
| Total Device Dissipation @ $T_A = 25^\circ\text{C}$ Derate above 25°C | P_D | 50 0.5 | mW mW/ $^\circ\text{C}$ |
| Operating Temperature Range | T_A | –55 to +125 | $^\circ\text{C}$ |
| Storage Temperature Range | T_{stg} | –65 to +150 | $^\circ\text{C}$ |

ELECTRICAL CHARACTERISTICS ($T_A = 25^\circ\text{C}$)

| Characteristic | Symbol | Min | Typ | Max | Unit |
|---|-------------|-----|-----|-----|------------------------------|
| Dark Current ($V_R = 5\text{ V}$, $R_L = 1\text{ M}$, $H = 0$, Figure 2) | I_D | — | — | 1 | nA |
| Reverse Breakdown Voltage ($I_R = 10\ \mu\text{A}$) | $V_{(BR)R}$ | 50 | — | — | Volts |
| Forward Voltage ($I_F = 50\text{ mA}$) | V_F | — | 2 | 2.5 | Volts |
| Total Capacitance ($V_R = 5\text{ V}$, $f = 1\text{ MHz}$) | C_T | — | — | 2.5 | pF |
| Noise Equivalent Power | NEP | — | 50 | — | $\text{fW}/\sqrt{\text{Hz}}$ |

OPTICAL CHARACTERISTICS ($T_A = 25^\circ\text{C}$)

| | | | | | |
|--|------------|-----|--------------|---|---------------------------|
| Responsivity @ 850 nm ($V_R = 5\text{ V}$, $P = 10\ \mu\text{W}$, Figure 3, 5) | R | 0.3 | 0.35 | — | $\mu\text{A}/\mu\text{W}$ |
| Response Time @ 850 nm ($V_R = 20\text{ V}$) | t_r, t_f | — | 1.2 | 3 | ns |
| Effective Input Port Diameter (Figure 4) | — | — | 300 0.012 | — | Microns Inches |
| 10 dB (90%) Numerical Aperture of Input Port (Figure 4) | NA | — | 0.4 | — | — |

MFOD1100

HERMETIC FAMILY
FIBER OPTICS
PHOTO DETECTOR
DIODE OUTPUT

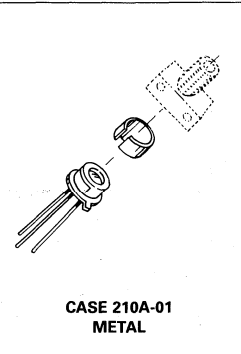

MFOD1100

TYPICAL CHARACTERISTICS

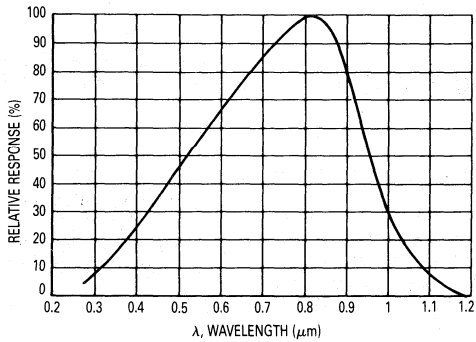

Figure 1. Relative Spectral Response

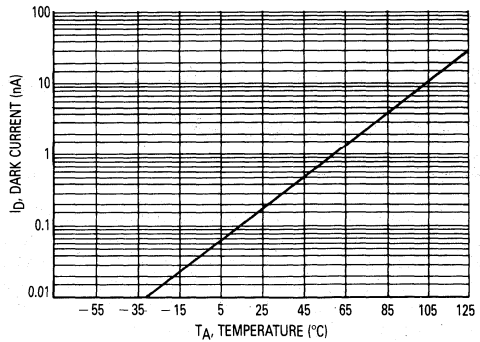

Figure 2. Dark Current versus Temperature

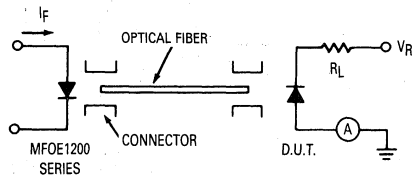

Figure 3. Responsivity Test Configuration

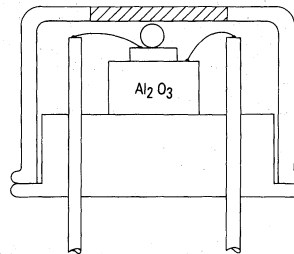
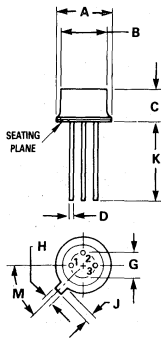

Figure 4. Package Cross Section

OUTLINE DIMENSIONS



- NOTES:
- PIN 2 INTERNALLY CONNECTED TO CASE.
 - LEAD POSITIONAL TOLERANCE AT SEATING PLANE:
 $\pm \phi 0.36 (0.014) \text{ (M)} | \text{ (T)} | \text{ (A)} | \text{ (H)} | \text{ (M)}$
 - DIMENSIONS A AND H ARE DATUMS AND T IS A DATUM PLANE.

- STYLE 1:
 PIN 1: ANODE
 PIN 2: CATHODE
 3: CASE

| DIM | MILLIMETERS | | INCHES | |
|-----|-------------|------|-----------|-------|
| | MIN | MAX | MIN | MAX |
| A | 5.31 | 5.84 | 0.209 | 0.230 |
| B | 4.65 | 4.70 | 0.183 | 0.185 |
| C | 3.12 | 3.28 | 0.123 | 0.129 |
| D | 0.41 | 0.48 | 0.016 | 0.019 |
| G | 2.54 BSC | | 0.100 BSC | |
| H | 0.99 | 1.17 | 0.039 | 0.046 |
| J | 0.84 | 1.22 | 0.033 | 0.048 |
| K | 12.70 | — | 0.500 | — |
| M | 45° BSC | | 45° BSC | |

CASE 210A-01
 METAL

5

Fiber Optics — High Performance Family

Photo Detector

Preamplifier Output

MFOD2404

**HERMETIC FAMILY
 FIBER OPTICS
 PHOTO DETECTOR
 PREAMPLIFIER OUTPUT**

... designed as a monolithic integrated circuit containing both detector and preamplifier for use in medium bandwidth, medium distance systems. It is packaged in Motorola's hermetic TO-206AC (TO-52) case, and fits directly into standard fiber optics connectors which also provide excellent RFI immunity. The output of the device is low impedance to provide even less sensitivity to stray interference. The MFOD2404 has a 300 μm (12 mil) optical spot with a high numerical aperture.

- Usable for Data Systems Up to 10 Megabaud
- Dynamic Range Greater than 100:1
- Compatible with AMP #228756-1, Amphenol #905-138-5001 Receptacles Using Motorola Alignment Bushing MFOA06 (Included)
- Performance Matched to Motorola Fiber Optics Emitter
- TO-206AC (TO-52) Package — Small, Rugged and Hermetic
- 300 μm (12 mil) Diameter Optical Spot

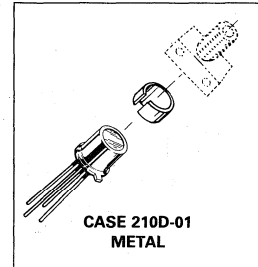

MAXIMUM RATINGS

| Rating | Symbol | Value | Unit |
|-----------------------------|------------------|-------------|-------|
| Supply Voltage | V _{CC} | 7.5 | Volts |
| Operating Temperature Range | T _A | -55 to +125 | °C |
| Storage Temperature Range | T _{stg} | -65 to +150 | °C |

ELECTRICAL CHARACTERISTICS (V_{CC} = 5 V, T_A = 25°C)

| Characteristic | Symbol | Conditions | Min | Typ | Max | Units |
|---|-----------------|------------|-----|-----|-----|-------|
| Power Supply Current | I _{CC} | Circuit A | 3 | 3.5 | 5 | mA |
| Quiescent dc Output Voltage (Noninverting Output) | V _q | Circuit A | 0.5 | 0.6 | 0.7 | Volts |
| Quiescent dc Output Voltage (Inverting Output) | V _q | Circuit A | 2.7 | 3 | 3.3 | Volts |
| RMS Noise Output | V _{NO} | Circuit A | — | 0.4 | 1 | mV |

OPTICAL CHARACTERISTICS

| Characteristic | Symbol | Conditions | Min | Typ | Max | Units |
|---|---------------------------------|------------|----------|----------|----------|-------------------|
| Responsivity (V _{CC} = 5 V, P = 2 μW) (Note 1) | R | Circuit B | 20 23 | 30 35 | 50 58 | mV/ μW |
| | | | | | | |
| Sensitivity (10 Mb/s NRZ, BER = 10 ⁻⁹) | S | | 0.1 | — | — | μW |
| Pulse Response | t _r , t _f | Circuit B | — | 35 | 50 | ns |
| Numerical Aperture of Input Port (300 μm [12 mil] diameter spot) | NA | | — | 0.5 | — | — |
| Signal-to-Noise Ratio @ P _{in} = 1 μW peak (Note 2) | S/N | | — | 35 | — | dB |
| Maximum Input Power for Negligible Distortion in Output Pulse (V _{CC} = 5 V, Note 2) | | | — | — | 30 | μW |

RECOMMENDED OPERATING CONDITIONS

| Supply Voltage | V _{CC} | 4 | 5 | 6 | Volts |
|---------------------------------|-----------------|-----|-----|-----|-------|
| Resistive Load (Either Output) | R _L | 200 | — | — | Ohms |
| Capacitive Load (Either Output) | C _L | — | — | 100 | pF |
| Input Wavelength | λ | — | 850 | — | nm |

Notes: 1. As measured on either output (single-ended). 2. Power launched into SMA type device receptacle.

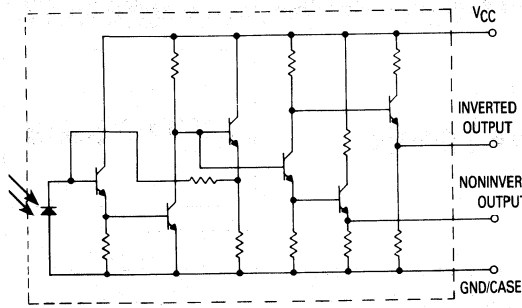

Figure 1. Equivalent Schematic

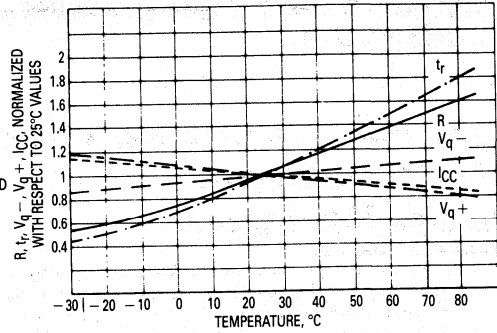
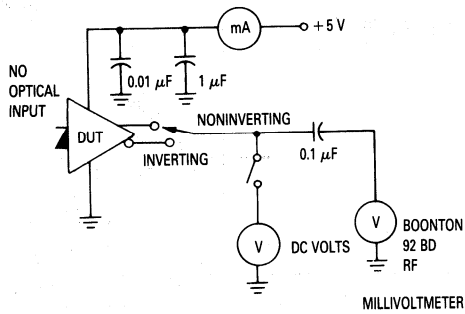

Figure 2. Typical Performance versus Temperature



Test Circuit A

OUTLINE DIMENSIONS

NOTES:
 1. DIMENSIONS A AND H ARE DATUMS AND T IS A DATUM SURFACE.
 2. LEAD POSITIONAL TOLERANCE AT SEATING PLANE:
 $\pm \begin{matrix} \Delta \\ \square \end{matrix} \begin{matrix} 0.038 \\ 0.014 \end{matrix} \begin{matrix} \text{M} \\ \text{M} \end{matrix} \begin{matrix} \text{T} \\ \text{T} \end{matrix} \begin{matrix} \text{A} \\ \text{A} \end{matrix} \begin{matrix} \text{H} \\ \text{H} \end{matrix} \begin{matrix} \text{M} \\ \text{M} \end{matrix}$
 3. DIMENSIONING AND TOLERANCING PER Y14.5, 1973.

STYLE 1:
 1. - VOLT
 2. + VOLT
 3. GROUND CASE
 4. + VCC

| DIM | MILLIMETERS | | INCHES | |
|-----|-------------|------|-----------|-------|
| | MIN | MAX | MIN | MAX |
| A | 5.30 | 5.38 | 0.209 | 0.212 |
| B | 4.54 | 4.69 | 0.183 | 0.185 |
| C | 3.42 | 3.60 | 0.135 | 0.142 |
| D | 0.40 | 0.48 | 0.016 | 0.019 |
| G | 2.54 BSC | | 0.100 BSC | |
| H | 0.91 | 1.16 | 0.036 | 0.046 |
| J | 0.83 | 1.21 | 0.033 | 0.048 |
| K | 12.70 | — | 0.500 | — |
| M | 45° BSC | | 45° BSC | |

CASE 210D-01 METAL

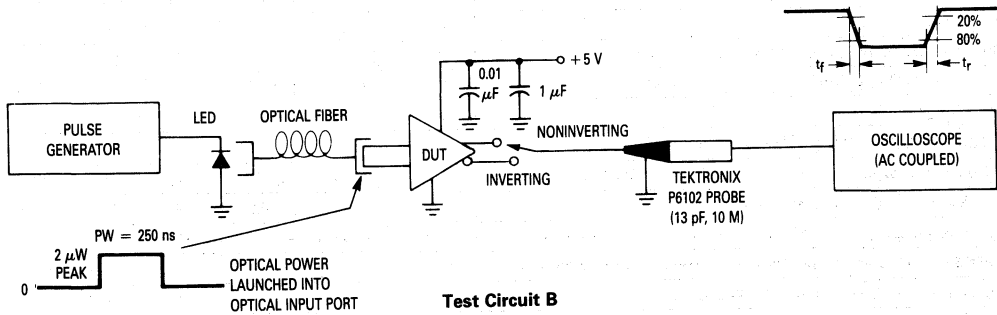

Test Circuit B

Fiber Optics — High Performance Family
Photo Detector
Preamplifier Output

MFOD2405

HERMETIC FAMILY
FIBER OPTICS
PHOTO DETECTOR
PREAMPLIFIER OUTPUT

... designed as a monolithic integrated circuit containing both detector and preamplifier for use in computer, industrial control, and other communications systems.

Packaged in Motorola's hermetic TO-206AC (TO-52) case, the device fits directly into standard fiber optics connectors which also provide excellent RFI immunity. The output of the device is low impedance to provide even less sensitivity to stray interference. The MFOD2405 has a 300 μm (12 mil) optical spot with a high numerical aperture.

- Usable for Data Systems Through 40 Megabaud
- Dynamic Range Greater than 100:1
- Compatible with AMP #228756-1 and Amphenol #905-138-5001 Receptacles Using Motorola Plastic Alignment Bushing #MFOA06 (Included)
- Performance Matched to Motorola Fiber Optics Emitter
- TO-206AC (TO-52) Package — Small, Rugged and Hermetic
- 300 μm (12 mil) Diameter Optical Spot

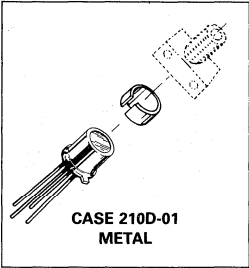

MAXIMUM RATINGS ($T_A = 25^\circ\text{C}$ unless otherwise noted)

| Rating | Symbol | Value | Unit |
|-----------------------------|-----------|-------------|------------------|
| Supply Voltage | V_{CC} | 7.5 | Volts |
| Operating Temperature Range | T_A | -55 to +125 | $^\circ\text{C}$ |
| Storage Temperature Range | T_{stg} | -65 to +150 | $^\circ\text{C}$ |

ELECTRICAL CHARACTERISTICS ($V_{CC} = 5\text{ V}$, $T_A = 25^\circ\text{C}$)

| Characteristic | Symbol | Conditions | Min | Typ | Max | Units |
|---|----------|------------|-----|-----|-----|-------|
| Power Supply Current | I_{CC} | Circuit A | 3 | 4.5 | 6 | mA |
| Quiescent dc Output Voltage (Noninverting Output) | V_q | Circuit A | 0.6 | 0.7 | 0.8 | Volts |
| Quiescent dc Output Voltage (Inverting Output) | V_q | Circuit A | 2.7 | 3 | 3.3 | Volts |
| RMS Noise Output | V_{NO} | Circuit A | — | 0.5 | 1 | mV |

OPTICAL CHARACTERISTICS ($T_A = 25^\circ\text{C}$)

| | | | | | | |
|--|------------|-----------|-----|-----|-----|-------------------------|
| Responsivity ($V_{CC} = 5\text{ V}$, $\lambda = 850\text{ nm}$, $P = 10\ \mu\text{W}$, Note 1) | R | Circuit B | 3 | 6 | 8 | $\text{mV}/\mu\text{W}$ |
| Sensitivity (40 Mb/s NRZ, BER = 10^{-9}) | S | | 0.8 | — | — | μW |
| Pulse Response | t_r, t_f | Circuit B | — | 10 | 15 | ns |
| Numerical Aperture of Input Port (300 μm [12 mil] diameter spot) | NA | | — | 0.5 | — | — |
| Signal-to-Noise Ratio @ $P_{in} = 2\ \mu\text{W}$ peak (Note 2) | S/N | | — | 24 | — | dB |
| Maximum Input Power for Negligible Distortion in Output Pulse ($V_{CC} = 5\text{ V}$, Note 2) | | Circuit B | — | — | 120 | μW |

RECOMMENDED OPERATING CONDITIONS

| | | | | | | |
|---------------------------------|-----------|--|-----|-----|-----|-------|
| Supply Voltage | V_{CC} | | 4 | 5 | 6 | Volts |
| Resistive Load (Either Output) | R_L | | 400 | — | — | Ohms |
| Capacitive Load (Either Output) | C_L | | — | — | 100 | pF |
| Input Wavelength | λ | | — | 850 | — | nm |

Notes: 1. As measured on either output (single-ended). 2. Power launched into SMA type device receptacle.

5

MFOD2405

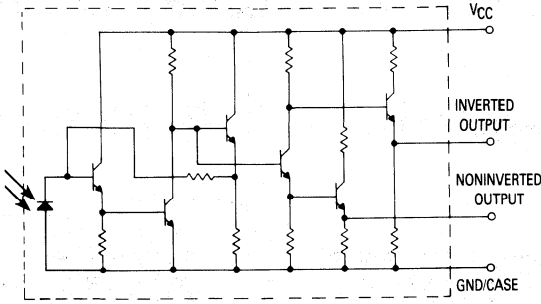

Figure 1. Equivalent Schematic

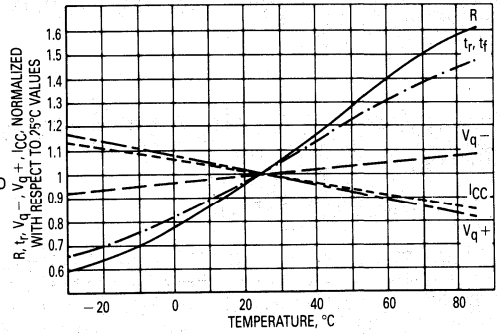
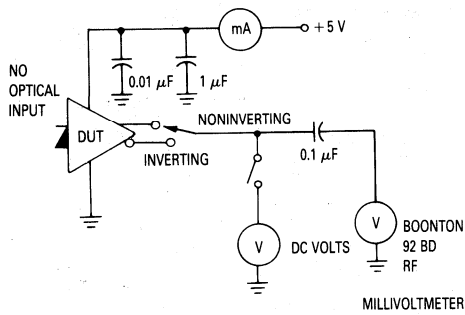
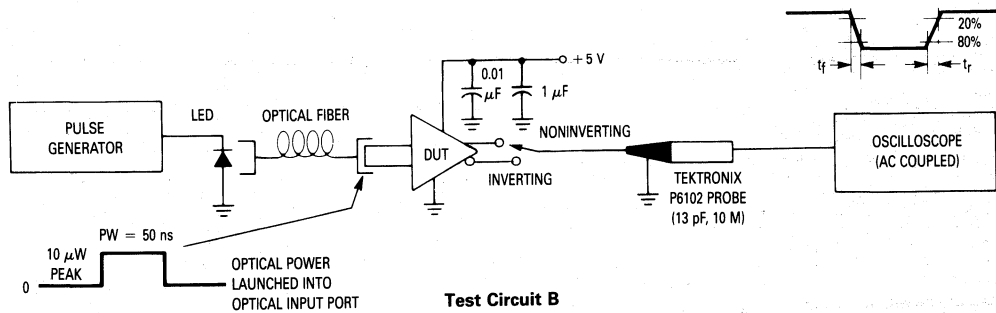
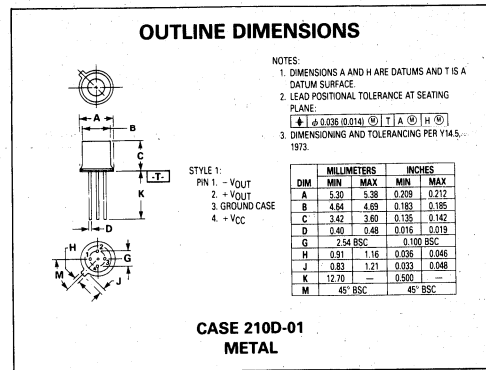

Figure 2. Typical Performance versus Temperature



Test Circuit A



Test Circuit B

Fiber Optics — MOD Family

Photo Detector

Diode Output

... designed for low cost infrared radiation detection in high frequency Fiber Optics Systems. Motorola's package fits directly into standard fiber optics connectors. Metal connectors provide excellent RFI immunity. Major applications are: CATV, video systems, M68000 microprocessor systems, industrial controls, computer and peripheral equipment, etc.

- Fast Response — 5 ns Max @ 5 Volts
- Analog Bandwidth (–3 dB) Greater Than 100 MHz
- Performance Matched to Motorola Fiber Optics Emitters
- Plastic Package — Small, Rugged and Inexpensive
- Mates snugly with AMP #228756-1, Amphenol #905-138-5001, OFTI #PCR001 Receptacles
- Low Cost

MAXIMUM RATINGS ($T_A = 25^\circ\text{C}$ unless otherwise noted)

| Rating | Symbol | Value | Unit |
|--|------------------|-------------|----------------------------|
| Reverse Voltage | V_R | 50 | Volts |
| Total Device Dissipation @ $T_A = 25^\circ\text{C}$ Derate above 25°C | P_D | 50 0.67 | mW mW/ $^\circ\text{C}$ |
| Operating Temperature Range | T_A | –40 to +100 | $^\circ\text{C}$ |
| Storage Temperature Range | T_{stg} | –40 to +100 | $^\circ\text{C}$ |

ELECTRICAL CHARACTERISTICS ($T_A = 25^\circ\text{C}$)

| Characteristic | Symbol | Min | Typ | Max | Unit |
|--|--------------------|-----|-----|-----|------------------------|
| Dark Current ($V_R = 5\text{ V}$, $H \approx 0$, Figure 2) | I_D | — | — | 1 | nA |
| Reverse Breakdown Voltage ($I_R = 10\ \mu\text{A}$) | $V_{(\text{BR})R}$ | 50 | — | — | Volts |
| Total Capacitance ($V_R = 5\text{ V}$, $f = 1\text{ MHz}$) | C_T | — | — | 5 | pF |
| Noise Equivalent Power | NEP | — | 50 | — | fW/ $\sqrt{\text{Hz}}$ |

OPTICAL CHARACTERISTICS ($T_A = 25^\circ\text{C}$)

| | | | | | |
|---|------------|-----|-----|---|---------------------------|
| Responsivity @ 850 nm ($V_R = 5\text{ V}$, $P = 10\ \mu\text{W}$, Figure 3) | R | 0.2 | 0.3 | — | $\mu\text{A}/\mu\text{W}$ |
| Response Time @ 850 nm ($V_R = 20\text{ V}$) | t_r, t_f | — | 2 | 5 | ns |

MFOD3100

**MOD FAMILY
 FIBER OPTICS
 PHOTO DETECTOR
 DIODE OUTPUT**

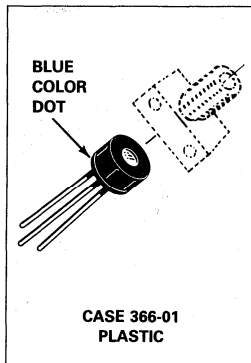

MFOD3100

TYPICAL CHARACTERISTICS

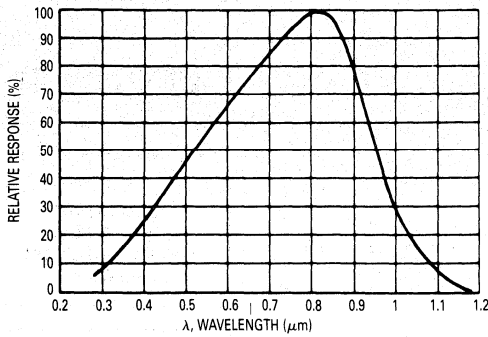

Figure 1. Relative Spectral Response

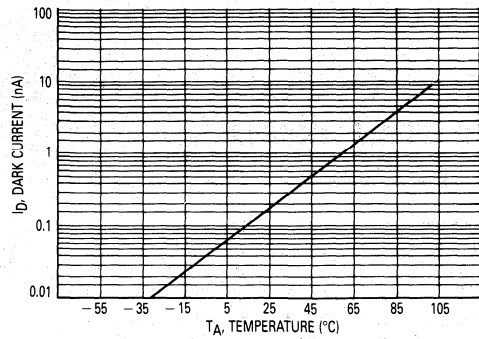

Figure 2. Dark Current versus Temperature

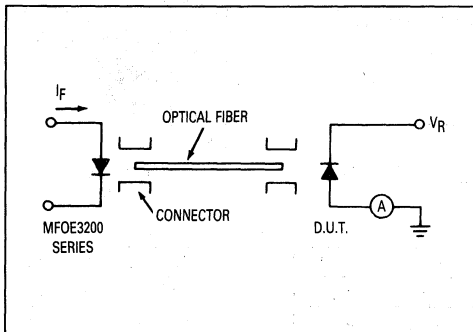
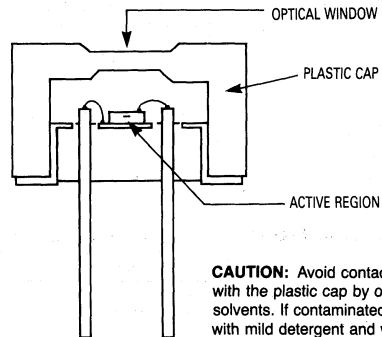
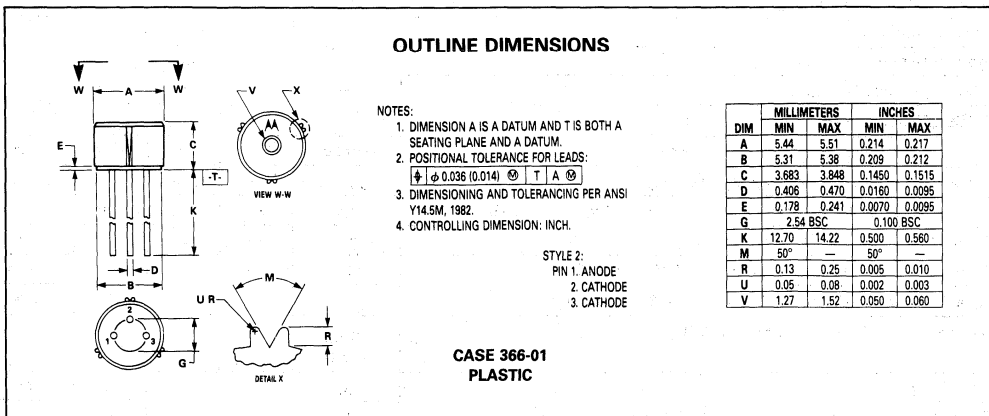

Figure 3. Responsivity Test Configuration



CAUTION: Avoid contact with the plastic cap by organic solvents. If contaminated, clean with mild detergent and water.

Figure 4. Package Cross Section



Fiber Optics — MOD Family

Photo Detector

Logic Output

MFOD3510

MOD FAMILY
FIBER OPTICS
PHOTO DETECTOR
LOGIC OUTPUT

... designed for moderate performance fiber optics systems using glass core fiber. Motorola's package is designed to be directly compatible with industry standard fiber optics connectors, which will provide excellent RFI immunity. Applications include M68000 microprocessor systems, computer peripheral equipment and industrial controls.

- Performance Matched to Motorola FO Emitters
- Plastic Package — Small, Rugged Inexpensive
- Mates with AMP #228756-1, Amphenol #905-138-5001 and OFT1 #PCR001 Connectors
- Low Cost

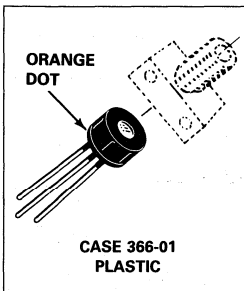

MAXIMUM RATINGS ($T_A = 25^\circ\text{C}$ unless otherwise noted)

| Rating | Symbol | Value | Unit |
|---|-----------------------|-------------|----------------------------|
| Supply Voltage Range | V_{CC} | 3–16 | Volts |
| Output Current | I_o | 50 | mA |
| Power Dissipation* Derate above 25°C | P_D ΔP_D | 50 0.67 | mW mW/ $^\circ\text{C}$ |
| Operating Temperature Range | T_A | -40 to +100 | $^\circ\text{C}$ |
| Junction Temperature Range | T_J | -40 to +100 | $^\circ\text{C}$ |
| Storage Temperature Range | T_{stg} | -55 to +100 | $^\circ\text{C}$ |
| Soldering Temperature (5 seconds) | — | 260 | $^\circ\text{C}$ |

DEVICE CHARACTERISTICS ($T_A = 25^\circ\text{C}$)

| Characteristic | Symbol | Min | Typ | Max | Unit |
|---|---------------------------|-----|------|-----|---------------|
| Supply Current with Output High ($I_F = 0$, $V_{CC} = 5\text{ V}$) | $I_{CC(off)}$ | — | 1.3 | 5 | mA |
| Output Current with Output High ($I_F = 0$, $V_{CC} = 15\text{ V}$, $R_L = 270\ \Omega$) | I_{OH} | — | — | 100 | nA |
| Supply Current with Output Low ($I_F = I_{F(on)}$, $V_{CC} = 5\text{ V}$) | $I_{CC(on)}$ | — | 3 | 5 | mA |
| Output Voltage, Low ($I_F = I_{F(on)}$, $V_{CC} = 5\text{ V}$, $R_L = 270\ \Omega$) | V_{OL} | — | 0.14 | 0.4 | Volts |
| Light Required to Trigger ($V_{CC} = 5\text{ V}$, $R_L = 270\ \Omega$, $\lambda = 850\text{ nm}$) | $H_{(on)}$ | — | 4 | 8 | μW |
| Hysteresis Ratio ($V_{CC} = 5\text{ V}$, $R_L = 270\ \Omega$) | $H_{(on)}$ $H_{(off)}$ | — | 0.75 | — | — |
| Turn-On Time | t_{on} | — | 0.4 | 2 | μs |
| Fall Time | t_f | — | 20 | — | ns |
| Turn-Off Time | t_{off} | — | 0.8 | 2 | μs |
| Rise Time | t_r | — | 40 | — | ns |

$V_{CC} = 5\text{ V}$, $R_L = 270\ \Omega$,
 $H = 20\ \mu\text{W}$, Figure 1,
 @ 850 nm

*Measured with device soldered into typical printed circuit board.

MFOD3510

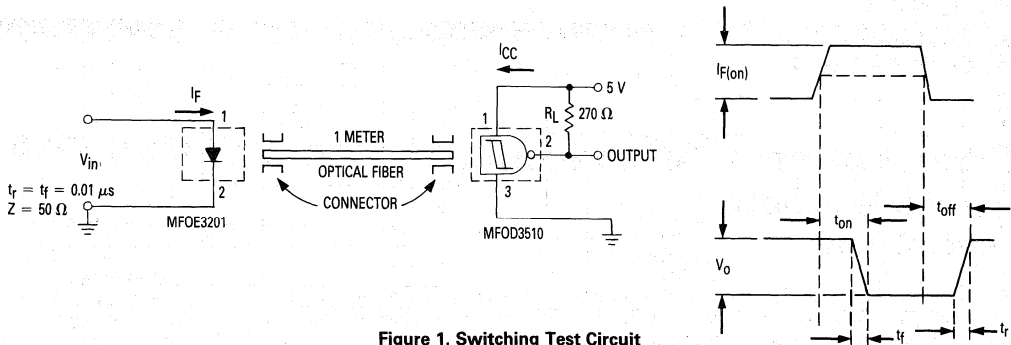

Figure 1. Switching Test Circuit

TYPICAL CHARACTERISTICS

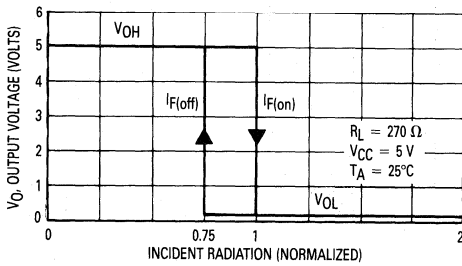

Figure 2. Transfer Characteristics

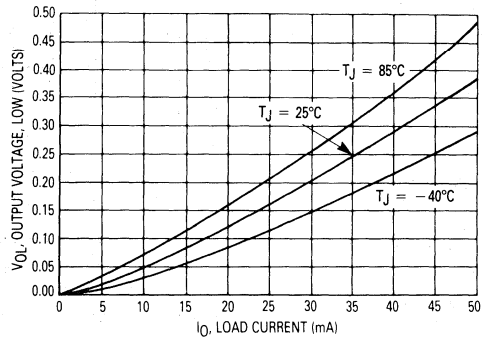

Figure 3. Output Voltage, Low versus Load Current

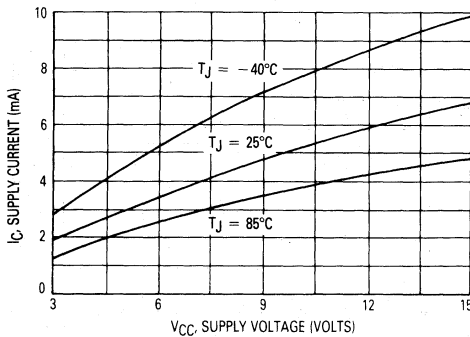

Figure 4. Supply Current versus Supply Voltage — Output Low

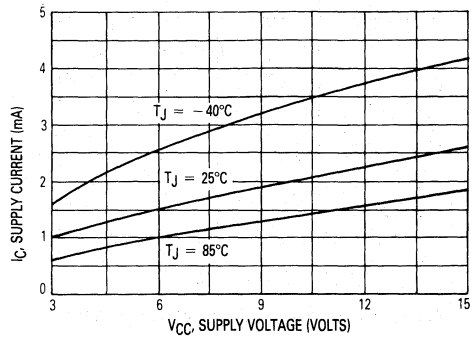

Figure 5. Supply Current versus Supply Voltage — Output High

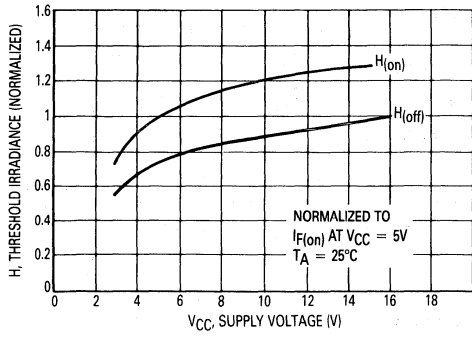

Figure 6. Threshold Irradiance versus Supply Voltage

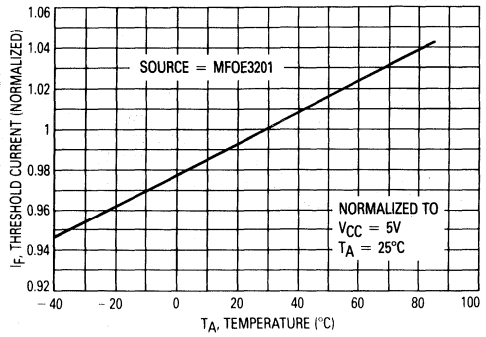

Figure 7. Threshold Current versus Temperature

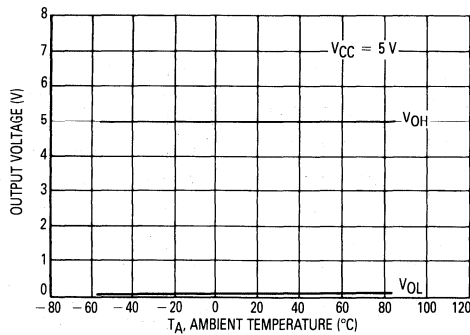

Figure 8. Output Voltage versus Ambient Temperature

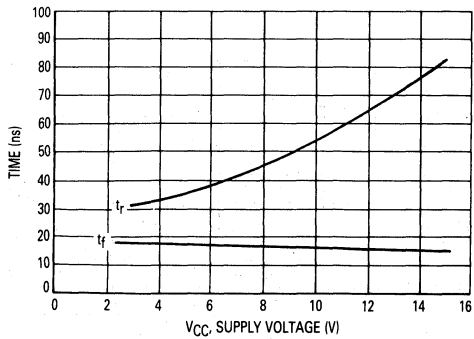

Figure 9. Pulse Response versus Supply Voltage

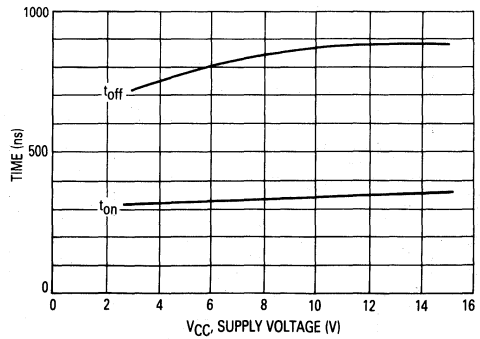
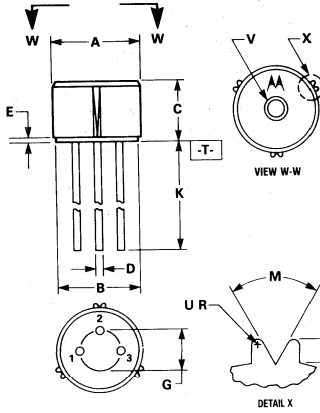

Figure 10. Total Switching Time versus Supply Voltage

5

MFOD3510

OUTLINE DIMENSIONS



- NOTES:
1. DIMENSION A IS A DATUM AND T IS BOTH A SEATING PLANE AND A DATUM.
 2. POSITIONAL TOLERANCE FOR LEADS:
 $\left[\begin{array}{c} \phi \\ \phi \end{array} \right] \phi 0.036 (0.014) \text{ } \textcircled{M} \text{ } | \text{ } \textcircled{T} \text{ } | \text{ } \textcircled{A} \text{ } \textcircled{R}$
 3. DIMENSIONING AND TOLERANCING PER ANSI Y14.5M, 1982.
 4. CONTROLLING DIMENSION: INCH.

STYLE 3:
 PIN 1. VCC
 2. VOUT
 3. GROUND/
 HEADER

| DIM | MILLIMETERS | | INCHES | |
|-----|-------------|-------|-----------|--------|
| | MIN | MAX | MIN | MAX |
| A | 5.44 | 5.51 | 0.214 | 0.217 |
| B | 5.31 | 5.38 | 0.209 | 0.212 |
| C | 3.683 | 3.848 | 0.1450 | 0.1515 |
| D | 0.406 | 0.470 | 0.0160 | 0.0095 |
| E | 0.178 | 0.241 | 0.0070 | 0.0095 |
| G | 2.54 BSC | | 0.100 BSC | |
| K | 12.70 | 14.22 | 0.500 | 0.560 |
| M | 50° | — | 50° | — |
| R | 0.13 | 0.25 | 0.005 | 0.010 |
| U | 0.05 | 0.08 | 0.002 | 0.003 |
| V | 1.27 | 1.52 | 0.050 | 0.060 |

CASE 366-01
 PLASTIC

Fiber Optics — FLCS Family Infrared LED

MFOE71

**FLCS FAMILY
 FIBER OPTICS
 INFRARED LED
 820 nm**

... designed for low cost, medium frequency, short distance Fiber Optics Systems using 1000 micron core plastic fiber.

Typical applications include: high isolation interconnects, disposable medical electronics, consumer products, and microprocessor controlled systems such as coin operated machines, copy machines, electronic games, industrial clothes dryers, etc.

- Fast Response — > 10 MHz
- Spectral Response Matched to FLCS Detectors: MFOD71, 72, 73, 75
- FLCS Package
 - Low Cost
 - Includes Connector
 - Simple Fiber Termination and Connection
 - Easy Board Mounting
 - Molded Lens for Efficient Coupling
 - Mates with 1000 Micron Core Plastic Fiber (Eska SH4001)

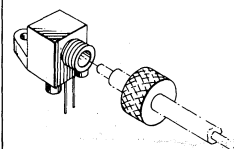

**CASE 363B-01
 PLASTIC**

MAXIMUM RATINGS

| Rating | Symbol | Value | Unit |
|---|----------------|-------------|----------------------------|
| Reverse Voltage | V_R | 6 | Volts |
| Forward Current — Continuous — Peak Pulse | I_F | 60 1 | mA A |
| Total Power Dissipation @ $T_A = 25^\circ\text{C}$ Derate above 25°C | $P_D(1)$ | 150 2 | mW mW/ $^\circ\text{C}$ |
| Operating and Storage Junction Temperature Range | T_J, T_{stg} | -40 to +100 | $^\circ\text{C}$ |
| Lead Solder Temperature (5 sec. max; 1/16 inch from case) | — | 260 | $^\circ\text{C}$ |

(1) Measured with the device soldered into a typical printed circuit board.

ELECTRICAL CHARACTERISTICS ($T_A = 25^\circ\text{C}$ unless otherwise noted)

| Characteristic | Fig. No. | Symbol | Min | Typ | Max | Unit |
|--|----------|-------------|-----|-----|-----|-------|
| Reverse Breakdown Voltage ($I_R = 100 \mu\text{A}$) | — | $V_{(BR)R}$ | 2 | 4 | — | Volts |
| Forward Voltage ($I_F = 100 \text{ mA}$) | — | V_F | — | 1.5 | 2 | Volts |

OPTICAL CHARACTERISTICS ($T_A = 25^\circ\text{C}$ unless otherwise noted)

| Characteristic | Fig. No. | Symbol | Min | Typ | Max | Unit |
|--|----------|-------------|-----|-----|-----|---------------|
| Power Launched ($I_F = 100 \text{ mA}$) | 4, 5 | P_L | 110 | 165 | — | μW |
| Optical Rise and Fall Time ($I_F = 100 \text{ mA}$) Figure 5 | 2 | t_r, t_f | — | 25 | 35 | ns |
| Peak Wavelength ($I_F = 100 \text{ mA}$) | 1 | λ_P | — | 820 | — | nm |

For simple fiber termination instructions, see the MFOD71, 72 and 73 data sheets.

5

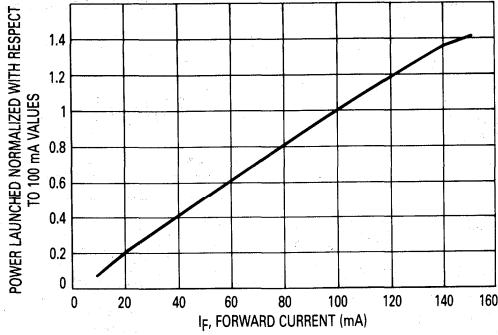

Figure 1. Normalized Power Launched versus Forward Current

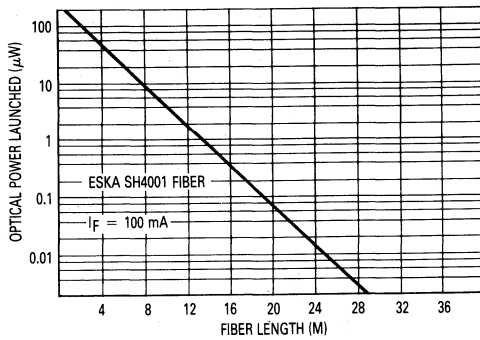

Figure 2. Power Launched versus Fiber Length

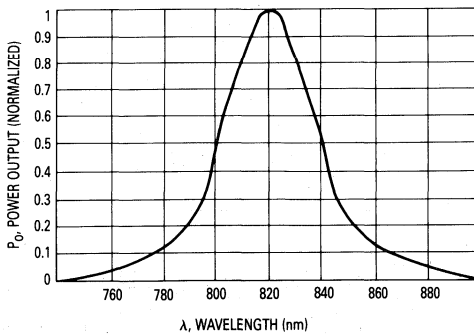

Figure 3. Typical Spectral Output versus Wavelength

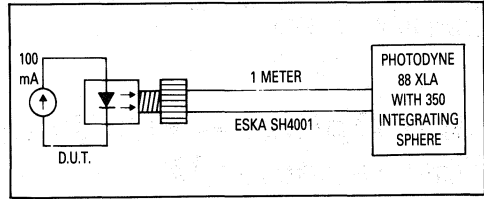

Figure 4. Power Launched Test Set

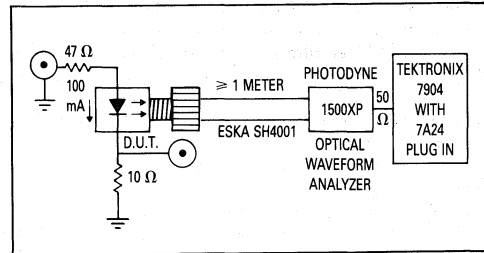
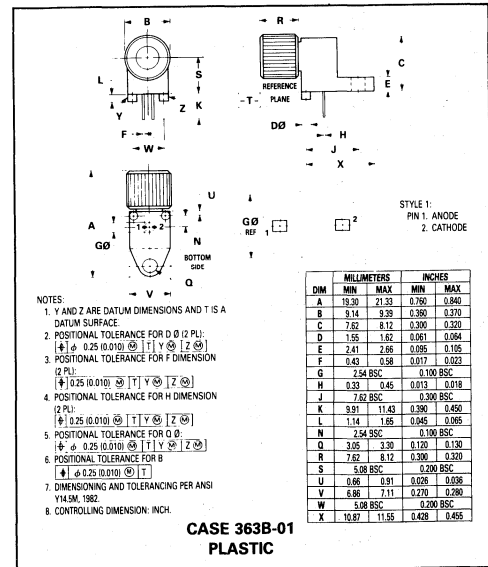

Figure 5. Optical Rise and Fall Time Test Set (10%-90%)



Fiber Optics — FLCS Family Visible Red LED

This device is designed for low cost, medium frequency, fiber optic systems using 1000 micron core plastic fiber. It is compatible with Motorola's wide variety of detector functions from the MFOD70 series. The MFOE76 employs gallium aluminum technology, and comes pre-assembled into the convenient and popular FLCS connector.

- Low Cost
- Very Simple Fiber Termination and Connection. See Figure 9
- Convenient Printed Circuit Mounting
- Integral Molded Lens for Efficient Coupling
- Mates with 1000 Micron Core Plastic Fiber, such as Eska SH4001

MFOE76

**FLCS FAMILY
 FIBER OPTICS
 VISIBLE RED
 LED
 660 nm**

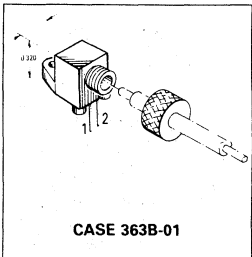

MAXIMUM RATINGS

| Rating | Symbol | Value | Unit |
|---|-----------|-------------|----------------------------|
| Reverse Voltage | V_R | 5 | Volts |
| Forward Current — Continuous | I_F | 60 | mA |
| Forward Current — Peak Pulse | I_F | 1 | A |
| Total Power Dissipation (at $T_A = 25^\circ\text{C}$ (1) Derate above 35°C) | P_D | 132 2 | mW mW/ $^\circ\text{C}$ |
| Ambient Operating Temperature Range | T_A | -40 to +100 | $^\circ\text{C}$ |
| Storage Temperature | T_{stg} | -40 to +100 | $^\circ\text{C}$ |
| Lead Soldering Temperature (2) | — | 260 | $^\circ\text{C}$ |

Notes: 1. Measured with device soldered into a typical printed circuit board.
 2. 5 seconds max; 1/16 inch from case.

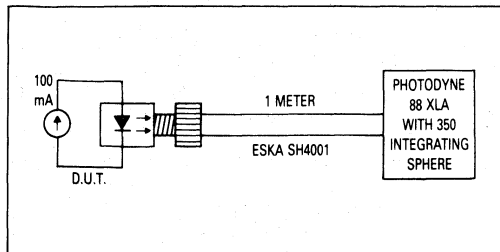

Figure 1. Power Launched Test Setup

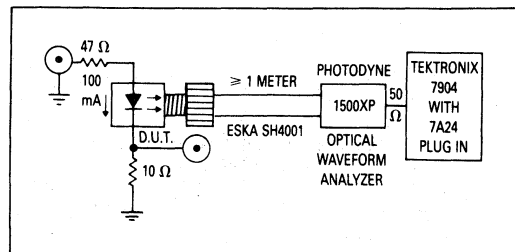

Figure 2. Optical Turn-On and Turn-Off Test Setup

MFOE76

ELECTRICAL CHARACTERISTICS ($T_A = 25^\circ\text{C}$ unless otherwise noted)

| Characteristic | Symbol | Min | Typ | Max | Unit |
|--|--------------|-----|------|-----|---------------|
| Reverse Leakage Current ($V_R = 3\text{ V}$) | I_R | — | 100 | — | nA |
| Reverse Leakage Current ($V_R = 5\text{ V}$) | I_R | — | 10 | 100 | μA |
| Forward Voltage ($I_F = 60\text{ mA}$) | V_F | — | 1.8 | 2.2 | V |
| Temperature Coefficient of Forward Voltage | ΔV_F | — | -2.2 | — | mV/K |
| Capacitance ($f = 1\text{ MHz}$) | C | — | 50 | — | pF |

OPTICAL CHARACTERISTICS ($T_A = 25^\circ\text{C}$ unless otherwise noted)

| Characteristic | Symbol | Min | Typ | Max | Unit |
|--|-------------|-----|-----|-----|---------------|
| Peak Wavelength ($I_F = 60\text{ mA}$) | λ_P | — | 660 | — | nm |
| Instantaneous Power Launched ($I_F = 100\text{ mA}$, Figure 1) | P_L | 200 | 540 | — | μW |
| Optical Turn-On Time (Figure 2) | t_{on} | — | 200 | — | ns |
| Optical Turn-Off Time (Figure 2) | t_{off} | — | 150 | — | ns |
| Half-Power Electrical Bandwidth (1) | BWe | — | 6 | — | MHz |

(1) $I_F = 100\text{ mA}$ pk-pk, 100% modulation.

TYPICAL CHARACTERISTICS

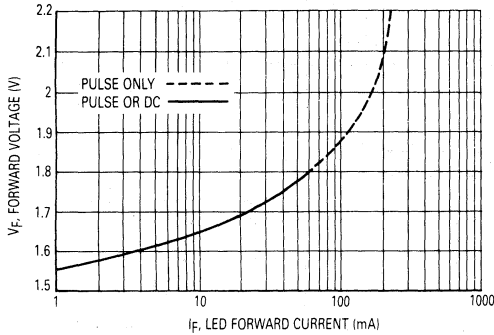

Figure 3. Forward Voltage versus Forward Current

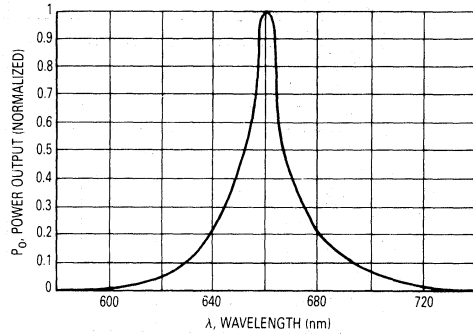

Figure 4. Relative Spectral Output

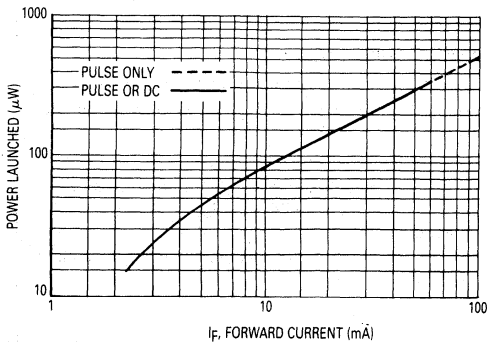

Figure 5. Power Launched versus LED Forward Current

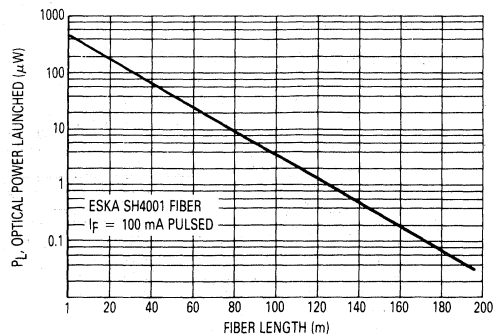

Figure 6. Power Launched versus Fiber Length

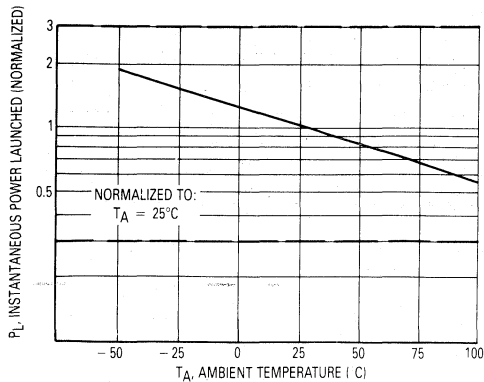

Figure 7. Instantaneous Power Output versus Ambient Temperature

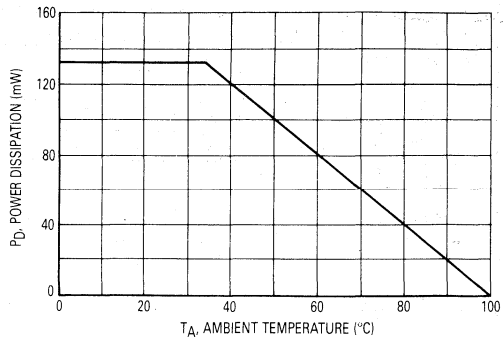

Figure 8. Power Dissipation

The system length achieved with a MFOE76 emitter and various detectors, using 1000 micron core plastic fiber (Eska SH4001 or equivalent), depends on the LED forward

current (I_F) and the responsivity of the detector chosen. Each detector will perform with the MFOE76 up to the distances shown below.

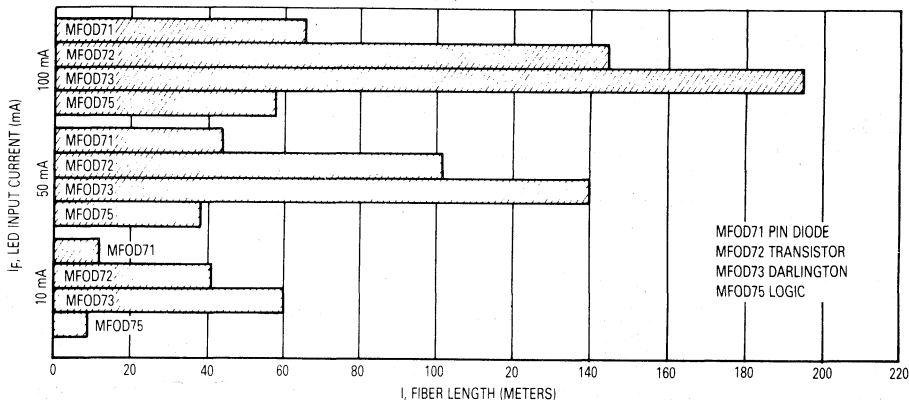

Figure 9. MFOE76 Working Distances

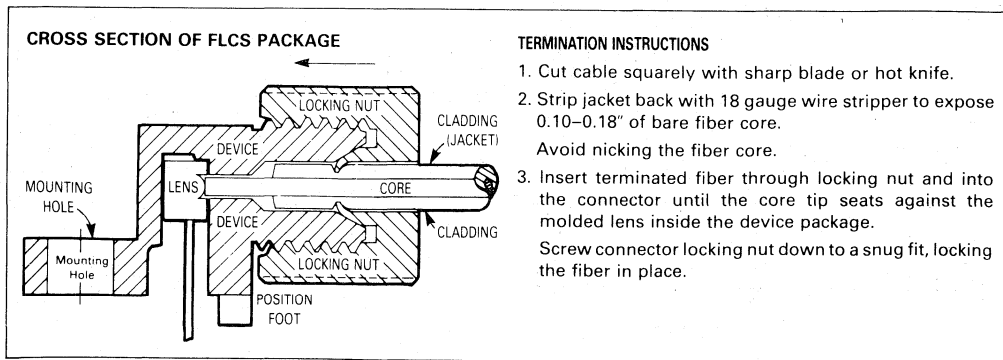
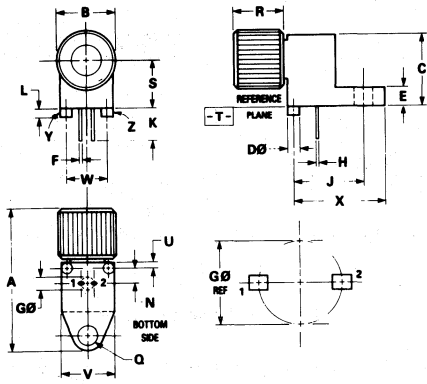

Figure 10. FO Cable Termination and Assembly

5

MFOE76

OUTLINE DIMENSIONS



- NOTES:
1. Y AND Z ARE DATUM DIMENSIONS AND T IS A DATUM SURFACE.
 2. POSITIONAL TOLERANCE FOR D Ø (2 PL):
 $\pm \phi 0.25 (0.010) \text{ (T | Y } \text{ (Z))}$
 3. POSITIONAL TOLERANCE FOR F DIMENSION (2 PL):
 $\pm 0.25 (0.010) \text{ (T | Y } \text{ (Z))}$
 4. POSITIONAL TOLERANCE FOR H DIMENSION (2 PL):
 $\pm 0.25 (0.010) \text{ (T | Y } \text{ (Z))}$
 5. POSITIONAL TOLERANCE FOR Q Ø:
 $\pm \phi 0.25 (0.010) \text{ (T | Y } \text{ (Z))}$
 6. POSITIONAL TOLERANCE FOR B
 $\pm \phi 0.25 (0.010) \text{ (T) }$
 7. DIMENSIONING AND TOLERANCING PER ANSI Y14.5M, 1982.
 8. CONTROLLING DIMENSION: INCH.

| DIM | MILLIMETERS | | INCHES | |
|-----|-------------|-------|-----------|-------|
| | MIN | MAX | MIN | MAX |
| A | 19.30 | 21.33 | 0.760 | 0.840 |
| B | 9.14 | 9.39 | 0.360 | 0.370 |
| C | 7.62 | 8.12 | 0.300 | 0.320 |
| D | 1.55 | 1.62 | 0.061 | 0.064 |
| E | 2.41 | 2.66 | 0.095 | 0.105 |
| F | 0.43 | 0.58 | 0.017 | 0.023 |
| G | 2.54 BSC | | 0.100 BSC | |
| H | 0.33 | 0.45 | 0.013 | 0.018 |
| J | 7.62 BSC | | 0.300 BSC | |
| K | 9.91 | 11.43 | 0.390 | 0.450 |
| L | 1.14 | 1.65 | 0.045 | 0.065 |
| N | 2.54 BSC | | 0.100 BSC | |
| Q | 3.05 | 3.30 | 0.120 | 0.130 |
| R | 7.62 | 8.12 | 0.300 | 0.320 |
| S | 5.08 BSC | | 0.200 BSC | |
| U | 0.66 | 0.91 | 0.026 | 0.036 |
| V | 6.86 | 7.11 | 0.270 | 0.280 |
| W | 5.08 BSC | | 0.200 BSC | |
| X | 10.87 | 11.55 | 0.428 | 0.455 |

STYLE 1:
 PIN 1. ANODE
 2. CATHODE

**CASE 363B-01
 PLASTIC**

Fiber Optics
Infrared LED

MFOE200

... designed as an infrared source in low frequency, short length Fiber Optics Systems.
 Typical applications include: medical electronics, industrial controls, M6800 Microprocessor systems, security systems, etc.

HERMETIC FAMILY
FIBER OPTICS
INFRARED LED

- High Power Output Liquid Phase Epitaxial Structure
- Performance Matched to MFOD100, 200, 300
- Hermetic Metal Package for Stability and Reliability
- Compatible With AMP Mounting Bushing #227015



CASE 209-02
METAL

MAXIMUM RATINGS

| Rating | Symbol | Value | Unit |
|--|-----------|-------------|-------------|
| Reverse Voltage | V_R | 3 | Volts |
| Forward Current — Continuous | I_F | 60 | mA |
| Total Device Dissipation @ $T_A = 25^\circ\text{C}$ Derate above 25°C | $P_D(1)$ | 250 2.27 | mW mW/°C |
| Operating Temperature Range | T_A | -55 to +125 | °C |
| Storage Temperature Range | T_{stg} | -65 to +150 | °C |

ELECTRICAL CHARACTERISTICS ($T_A = 25^\circ\text{C}$)

| Characteristics | Symbol | Min | Typ | Max | Unit |
|---|-------------|-----|-----|-----|-------|
| Reverse Leakage Current ($V_R = 3\text{ V}$, $R_L = 1\text{ Megohm}$) | I_R | — | 50 | — | nA |
| Reverse Breakdown Voltage ($I_R = 100\ \mu\text{A}$) | $V_{(BR)R}$ | 3 | — | — | Volts |
| Forward Voltage ($I_F = 100\text{ mA}$) | V_F | — | 1.5 | 1.7 | Volts |
| Total Capacitance ($V_R = 0\text{ V}$, $f = 1\text{ MHz}$) | C_T | — | 18 | — | pF |

OPTICAL CHARACTERISTICS ($T_A = 25^\circ\text{C}$)

| Characteristics | See Figures | Min | Typ | Max | Unit |
|---|-------------|----------------------|-----|-----|---------------|
| Total Power Output (2) ($I_F = 100\text{ mA}$, $\lambda \approx 940\text{ nm}$) | 1 and 2 | 2 | 3 | — | mW |
| Power Launched (3) ($I_F = 100\text{ mA}$) | | 35 | 45 | — | μW |
| Optical Turn-On and Turn-Off Time | | t_{on} , t_{off} | 250 | — | ns |

(1) Printed Circuit Board Mounting

(2) Total Power Output, P_O , is defined as the total power radiated by the device into a solid angle of 2π steradians.

(3) Power Launched, P_L , is the optical power exiting one meter of 0.045" diameter optical fiber bundle having $NA = 0.67$, Attenuation = 0.6 dB/m @ 940 nm, terminated with AMP connectors. (See Figure 1.)

MFOE200

TYPICAL CHARACTERISTICS

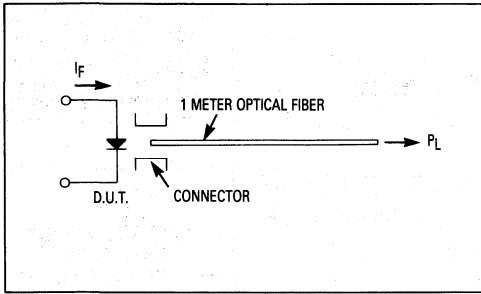

Figure 1. Launched Power Test Configuration

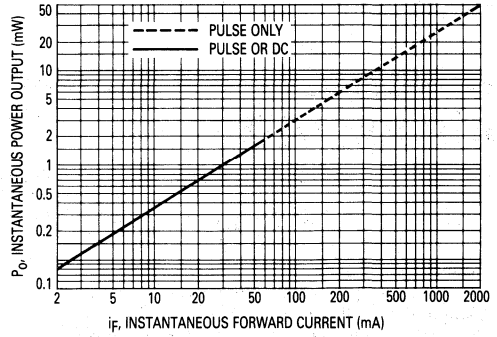

Figure 2. Instantaneous Power Output versus Forward Current

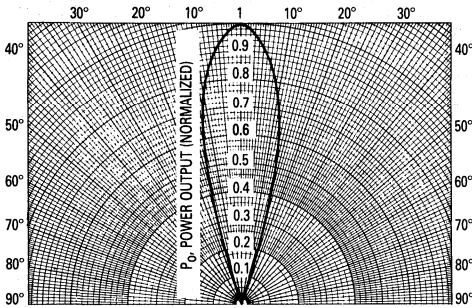

Figure 3. Spatial Radiation Pattern

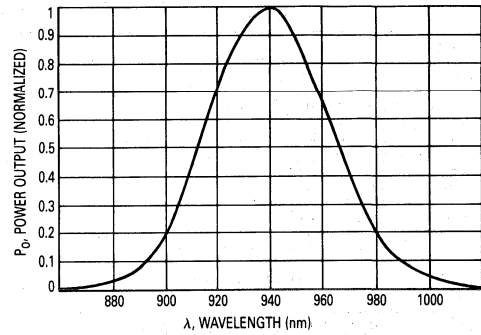
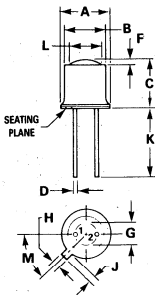

Figure 4. Relative Spectral Output

OUTLINE DIMENSIONS



- NOTES:
- PIN 2 INTERNALLY CONNECTED TO CASE.
 - LEADS WITHIN 0.13 mm (0.005) RADIUS OF TRUE POSITION AT SEATING PLANE AT MAXIMUM MATERIAL CONDITION.

STYLE 1:
PIN 1. ANODE
2. CATHODE

| DIM | MILLIMETERS | | INCHES | |
|-----|-------------|------|-----------|-------|
| | MIN | MAX | MIN | MAX |
| A | 5.31 | 5.84 | 0.209 | 0.230 |
| B | 4.52 | 4.95 | 0.178 | 0.195 |
| C | 6.22 | 6.98 | 0.245 | 0.275 |
| D | 0.41 | 0.48 | 0.016 | 0.019 |
| F | 1.19 | 1.60 | 0.047 | 0.063 |
| G | 2.54 BSC | | 0.100 BSC | |
| H | 0.99 | 1.17 | 0.039 | 0.046 |
| J | 0.84 | 1.22 | 0.033 | 0.048 |
| K | 12.70 | — | 0.500 | — |
| L | 3.35 | 4.01 | 0.132 | 0.158 |
| M | — | | 45° BSC | |

CASE 209-02
METAL

Fiber Optics — High Performance Family
Infrared LED

... designed for fiber optics applications requiring high-power and medium response time.

- Response — Digital Data to 30 Mbaud (NRZ) Guaranteed
- High Launch Power
- Hermetic Package
- Internal Lensing Enhances Coupling Efficiency
- Complements All Motorola Fiber Optics Detectors
- Compatible with AMP #228756-1, Amphenol #905-138-5001 and Deutsch 3146-04 Receptacles Using Motorola Alignment Bushing MFOA06 (Included)

MAXIMUM RATINGS

| Rating | Symbol | Value | Unit |
|--|-----------|-------------|-------------|
| Reverse Current | I_R | 1 | mA |
| Forward Current — Continuous | I_F | 100 | mA |
| Total Device Dissipation @ $T_A = 25^\circ\text{C}$ Derate above 25°C | P_D | 250 2.27 | mW mW/°C |
| Operating Temperature Range | T_A | -55 to +125 | °C |
| Storage Temperature Range | T_{stg} | -65 to +150 | °C |

THERMAL CHARACTERISTICS

| Characteristics | Symbol | Max | Unit |
|---|---------------|-------------|------|
| Thermal Resistance, Junction to Ambient | θ_{JA} | 440 225* | °C/W |

ELECTRICAL CHARACTERISTICS ($T_A = 25^\circ\text{C}$)

| Characteristic | Symbol | Min | Typ | Max | Unit |
|--|-------------|-----|-----|-----|-------|
| Reverse Breakdown Voltage ($I_R = 100 \mu\text{A}$) | $V_{(BR)R}$ | 2 | 8 | — | Volts |
| Forward Voltage ($I_F = 100 \text{mA}$) | V_F | 1.8 | 2 | 2.2 | Volts |
| Total Capacitance ($V_R = 0 \text{V}$, $f = 1 \text{MHz}$) | C_T | — | 70 | — | pF |
| Electrical Bandwidth, Figure 6 ($I_F = 80 \text{mAdc}$, measured 1 MHz to 30 MHz) | BWE | 15 | 20 | — | MHz |

OPTICAL CHARACTERISTICS ($T_A = 25^\circ\text{C}$)

| Characteristic | Symbol | Min | Typ | Max | Unit | |
|---|----------------------------------|-------|--|---------------|-------------------------------|--------------------|
| Total Power Output ($I_F = 100 \text{mA}$, $\lambda \approx 850 \text{nm}$) | MFOE1100 MFOE1101 MFOE1102 | P_O | — — — | 2.6 4 5 | mW | |
| Power Launched, Figure 7 ($I_F = 100 \text{mA}$) | MFOE1100 MFOE1101 MFOE1102 | P_L | 60 (-12.2) 120 (-9.2) 180 (-7.5) | — — — | — 240 (-6.2) 360 (-4.5) | $\mu\text{W(dBm)}$ |
| Numerical Aperture of Output Port (at -10 dB), Figure 3 (250 μm [10 mil] diameter spot) | NA | — | 0.30 | — | — | |
| Wavelength of Peak Emission @ 100 mAdc | λ | — | 850 | — | nm | |
| Spectral Line Half Width | — | — | 50 | — | nm | |
| Optical Rise and Fall Times, Figure 11 ($I_F = 100 \text{mAdc}$) | t_r | — | 15 | — | ns | |
| | t_f | — | 16 | — | | |

*Installed in compatible metal connector housing with Motorola alignment bushing.

MFOE1100
MFOE1101
MFOE1102

HERMETIC FAMILY
FIBER OPTICS
INFRARED LED

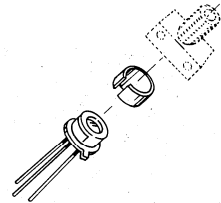

CASE 210A-01
METAL

5

MFOE1100, MFOE1101, MFOE1102

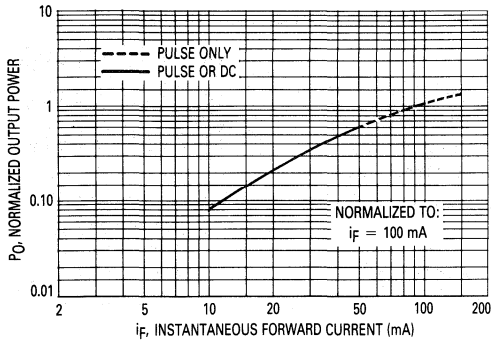

Figure 1. Normalized Output Power versus Forward Current

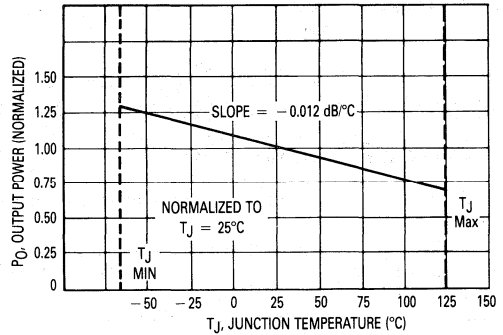

Figure 2. Power Output versus Junction Temperature

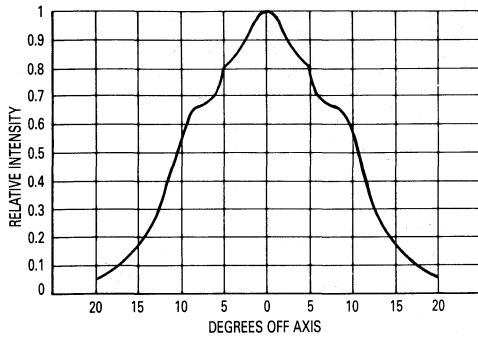

Figure 3. Radial Intensity Distribution

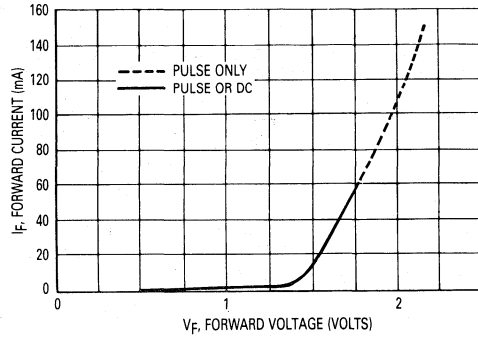

Figure 4. Forward Current versus Forward Voltage

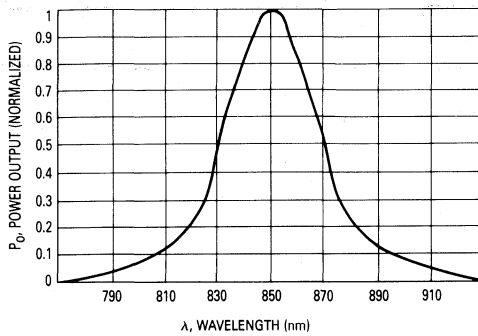

Figure 5. Spectral Output versus Wavelength

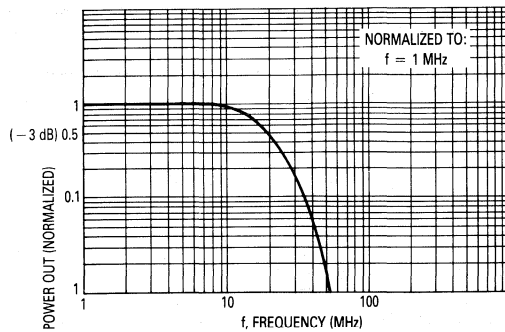

Figure 6. Normalized Output Power versus Frequency

MFOE1100, MFOE1101, MFOE1102

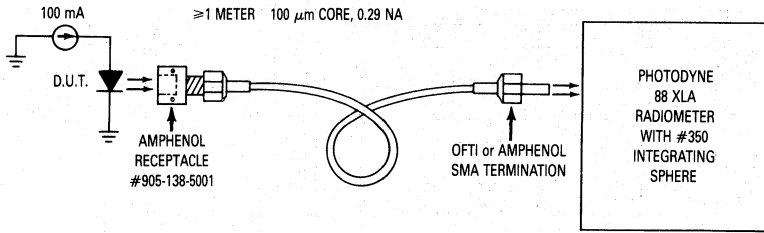

Figure 7. Launched Power Test Set

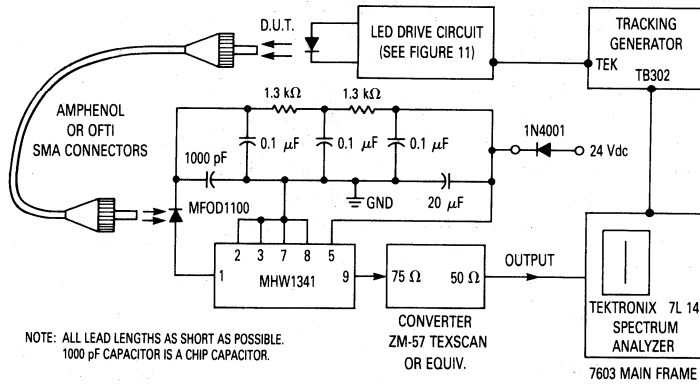

Figure 8. Bandwidth Test Set

5

MFOE1100, MFOE1101, MFOE1102

| AVERAGE COUPLING EFFICIENCY | | |
|---------------------------------------|--------------------|-------------------------|
| Fiber Core Diameter (μm) | Numerical Aperture | Coupling Efficiency (%) |
| 200 | 0.4 | 28 |
| 100 | 0.29 | 4.5 |
| 85 | 0.26 | 2.6 |
| 62.5 | 0.28 | 1.6 |
| 50 | 0.2 | 0.7 |

Figure 9. Coupling Efficiency

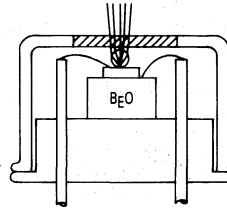

COMPATIBLE WITH AMP #228756-1, AMPHENOL #905-138-5001, DEUTSCH 3146-04 AND QFT1 # PCR001 RECEPTACLES USING MOTOROLA ALIGNMENT BUSHING MFOA06 (INCLUDED).

Figure 10. Package Cross Section

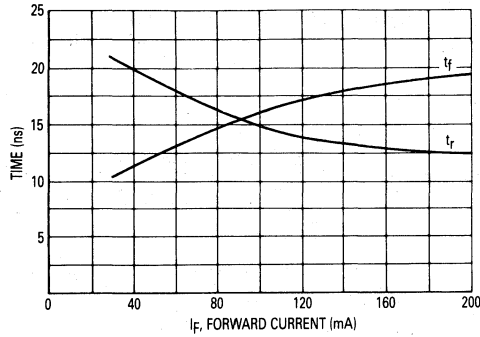

Figure 11. Rise and Fall Time versus Forward Current

5

OUTLINE DIMENSIONS

| DIM | MILLIMETERS | | INCHES | |
|-----|-------------|------|-----------|-------|
| | MIN | MAX | MIN | MAX |
| A | 5.30 | 5.38 | 0.209 | 0.212 |
| B | 4.64 | 4.69 | 0.183 | 0.185 |
| C | 3.42 | 3.60 | 0.135 | 0.142 |
| D | 0.40 | 0.48 | 0.016 | 0.019 |
| G | 2.54 BSC | | 0.100 BSC | |
| H | 0.91 | 1.16 | 0.036 | 0.046 |
| J | 0.83 | 1.21 | 0.033 | 0.048 |
| K | 12.70 | — | 0.500 | — |
| M | 45° BSC | | 45° BSC | |

STYLE 1:
 PIN 1. - VOUT
 2. + VOUT
 3. GROUND/CASE
 4. + VCC

NOTES:
 1. DIMENSIONS A AND H ARE DATUMS AND T IS A DATUM SURFACE.
 2. LEAD POSITIONAL TOLERANCE AT SEATING PLANE:
 $\pm \phi 0.036$ (0.014) $\text{\textcircled{T}}$ $\text{\textcircled{A}}$ $\text{\textcircled{H}}$ $\text{\textcircled{M}}$
 3. DIMENSIONING AND TOLERANCING PER Y14.5, 1973.

CASE 210A-01
METAL

Fiber Optics
Infrared LED

MFOE1200

... designed for fiber optics applications requiring high power and fast response time.

- Fast Response — > 70 MHz Bandwidth
- 250 μm Diameter Spot Size
- Hermetic Package
- Internal Lensing Enhances Coupling Efficiency
- Complements All Motorola FO Detectors
- Compatible With AMP #228756-1, Amphenol #905-138-5001, and Radial #FO86600380 Receptacles Using Motorola Alignment Bushing MFOA06 (Included)

HERMETIC FAMILY
FIBER OPTICS
INFRARED LED

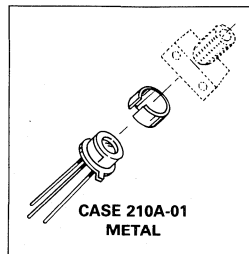

MAXIMUM RATINGS

| Rating | Symbol | Value | Unit |
|--|-----------|-------------|----------------------------|
| Reverse Current | I_R | 1 | mA |
| Forward Current — Continuous | I_F | 100 | mA |
| Total Device Dissipation ($\theta_{JA} = 25^\circ\text{C}$ Derate above 25°C) | P_D | 250 2.27 | mW mW/ $^\circ\text{C}$ |
| Operating Temperature Range | T_A | -55 to +125 | $^\circ\text{C}$ |
| Storage Temperature Range | T_{stg} | -65 to +150 | $^\circ\text{C}$ |

THERMAL CHARACTERISTICS

| Characteristic | Symbol | Max | Unit |
|---|---------------|-------------|---------------------------|
| Thermal Resistance, Junction to Ambient | θ_{JA} | 440 225* | $^\circ\text{C}/\text{W}$ |

ELECTRICAL CHARACTERISTICS ($T_A = 25^\circ\text{C}$)

| Characteristic | Symbol | Min | Typ | Max | Unit |
|---|--------|-----|-----|-----|-------|
| Forward Voltage ($I_F = 100\text{ mA}$) | V_F | — | 1.9 | 2.5 | Volts |
| Total Capacitance ($V_R = 0\text{ V}$, $f = 1\text{ MHz}$) | C_T | — | 70 | — | pF |

OPTICAL CHARACTERISTICS

| | | | | | |
|---|-------|-----|-----|---|---------------|
| Total Power Output from 250 μm Optical Spot ($I_F = 100\text{ mA}$, $\lambda \approx 850\text{ nm}$) | P_O | 900 | — | — | μW |
| Power Launched, Figure 4 ($I_F = 100\text{ mA}$) | P_L | 60 | — | — | μW |
| Numerical Aperture of Output Port (at -10 dB) (250 μm [10 mil] diameter spot) | NA | — | 0.3 | — | — |
| Wavelength of Peak Emission ($I_F = 100\text{ mAdc}$) | — | — | 850 | — | nm |
| Spectral Line Half Width | — | — | 50 | — | nm |
| Electrical Bandwidth ($I_F = 80\text{ mAdc}$) | BWE | 70 | — | — | MHz |

*Installed in compatible metal connector housing with Motorola alignment bushing.

MFOE1200

TYPICAL CHARACTERISTICS

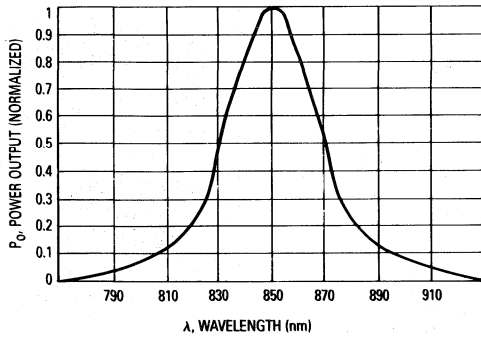

Figure 1. Relative Spectral Output

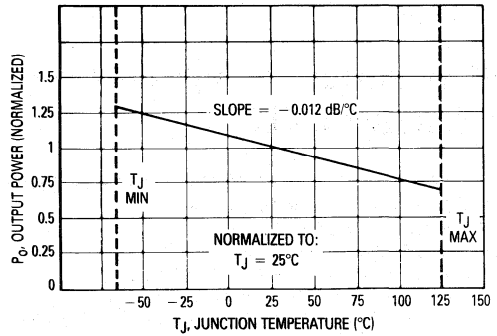

Figure 2. Power Output versus Junction Temperature

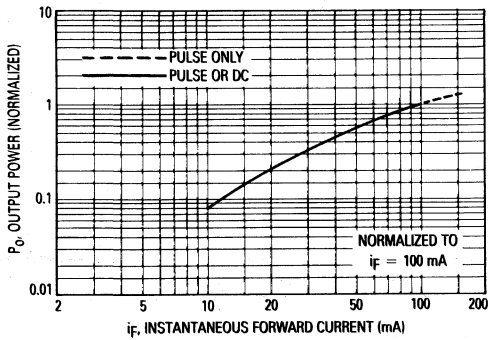

Figure 3. Power Output versus Forward Current

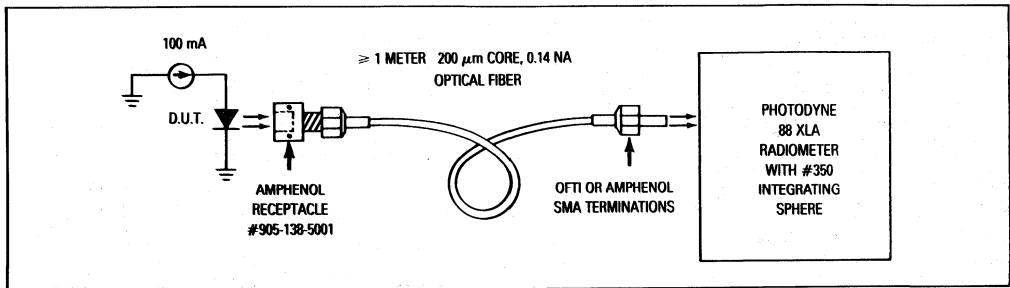
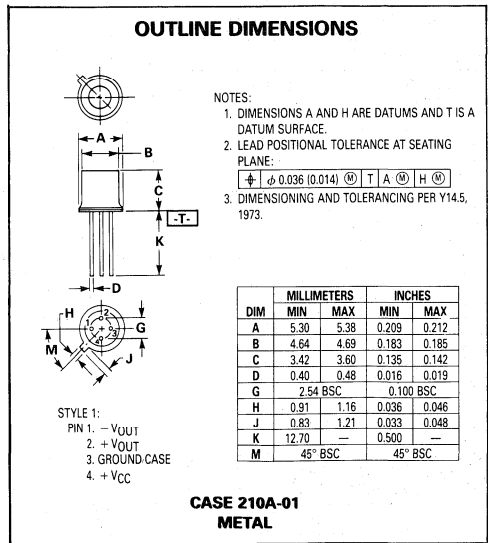

Figure 4. Launched Power (P_L) Test Set

Fiber Optics — High Performance Family
Infrared LED

MFOE1201
MFOE1202
MFOE1203

... designed for fiber optics applications requiring high power and fast response time.

- Fast Response — Digital Data to 200 Mbaud (NRZ)
- Guaranteed 100 MHz Analog Bandwidth
- Hermetic Package, Figure 10
- Internal Lensing Enhances Coupling Efficiency
- Complements All Motorola Fiber Optics Detectors

HERMETIC FAMILY
FIBER OPTICS
INFRARED LED

MAXIMUM RATINGS

| Rating | Symbol | Value | Unit |
|--|-----------|-------------|-------------|
| Reverse Current | I_R | 1 | mA |
| Forward Current — Continuous | I_F | 100 | mA |
| Total Device Dissipation @ $T_A = 25^\circ\text{C}$ Derate above 25°C | P_D | 250 2.27 | mW mW/°C |
| Operating Temperature Range | T_A | -55 to +125 | °C |
| Storage Temperature Range | T_{stg} | -65 to +150 | °C |

THERMAL CHARACTERISTICS

| Characteristics | Symbol | Max | Unit |
|---|---------------|-------------|------|
| Thermal Resistance, Junction to Ambient | θ_{JA} | 440 225* | °C/W |

*Installed in compatible metal connector housing with Motorola alignment bushing.

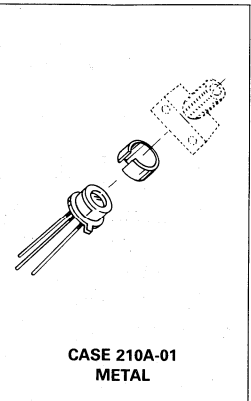

ELECTRICAL CHARACTERISTICS ($T_A = 25^\circ\text{C}$)

| Characteristic | Symbol | Min | Typ | Max | Unit |
|--|-------------|-----|-----|-----|-------|
| Reverse Breakdown Voltage ($I_R = 100 \mu\text{A}$) | $V_{(BR)R}$ | 2 | 4 | — | Volts |
| Forward Voltage ($I_F = 100 \text{mA}$) | V_F | 1.5 | 1.9 | 2.2 | Volts |
| Total Capacitance ($V_R = 0 \text{V}$, $f = 1 \text{MHz}$) | C_T | — | 70 | — | pF |
| Electrical Bandwidth, Figure 6 ($I_F = 80 \text{mAdc}$, measured 10 MHz to 110 MHz) | BWE | 100 | — | — | MHz |

OPTICAL CHARACTERISTICS ($T_A = 25^\circ\text{C}$)

| Characteristic | Symbol | Min | Typ | Max | Unit |
|---|-----------|-----------------------------------|---|-----------------------------------|---------------------------|
| Total Power Output ($I_F = 100 \text{mA}$, $\lambda = 850 \text{nm}$) | P_O | — | 1500 (1.76) 2400 (3.80) 2800 (4.46) | — | $\mu\text{W}(\text{dBm})$ |
| Power Launched, Figure 7 ($I_F = 100 \text{mA}$) | P_L | 40(-14) 75(-11.3) 135(-8.7) | — | 80(-11) 150(-8.3) 270(-5.7) | $\mu\text{W}(\text{dBm})$ |
| Numerical Aperture of Output Port (at -10 dB), Figure 3 (250 μm [10 mil] diameter spot) | NA | — | 0.3 | — | — |
| Wavelength of Peak Emission @ 100 mAdc | λ | — | 850 | — | nm |
| Spectral Line Half Width | — | — | 50 | — | nm |
| Optical Rise and Fall Times, Figure 12 ($I_F = 100 \text{mAdc}$) | t_r | — | 2.8 | 4 | ns |
| | t_f | — | 3.5 | 6 | |

5

MFOE1201, MFOE1202, MFOE1203

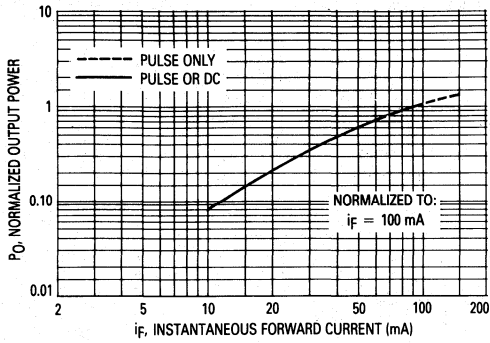

Figure 1. Normalized Output Power versus Forward Current

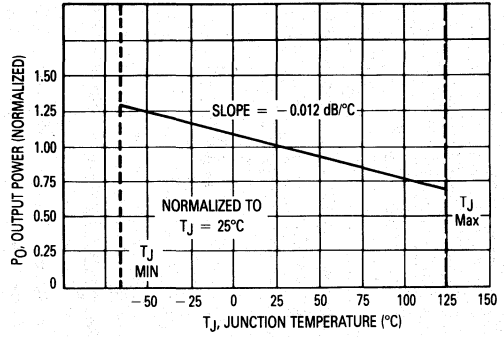

Figure 2. Power Output versus Junction Temperature

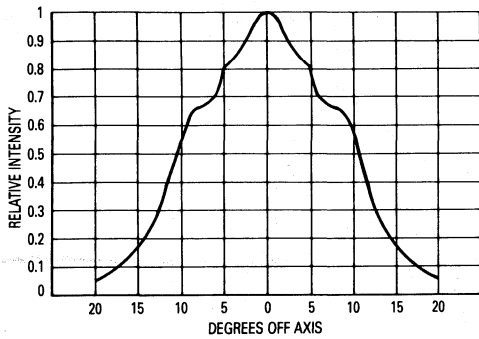

Figure 3. Radial Intensity Distribution

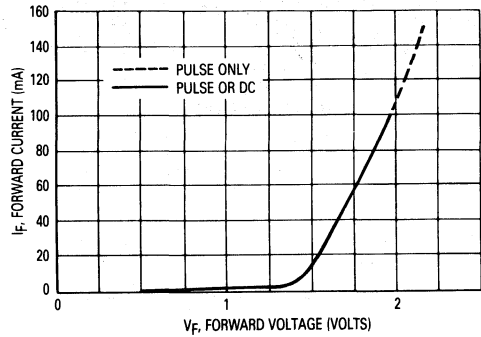

Figure 4. Forward Current versus Forward Voltage

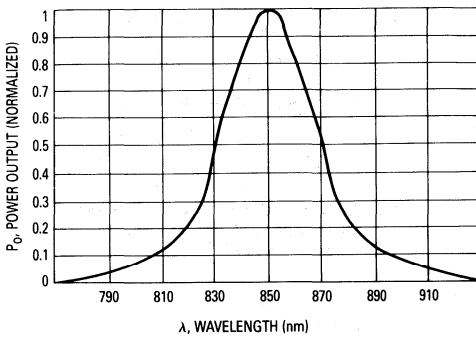

Figure 5. Spectral Output versus Wavelength

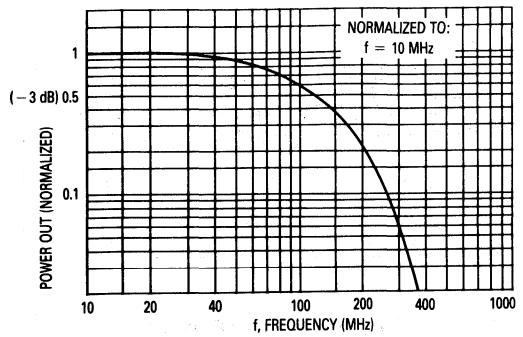

Figure 6. Normalized Output Power versus Frequency

MFOE1201, MFOE1202, MFOE1203

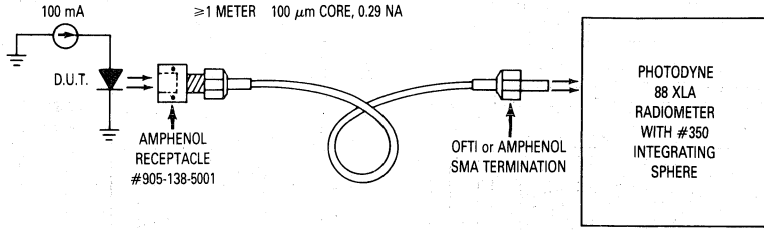

Figure 7. Launched Power Test Set

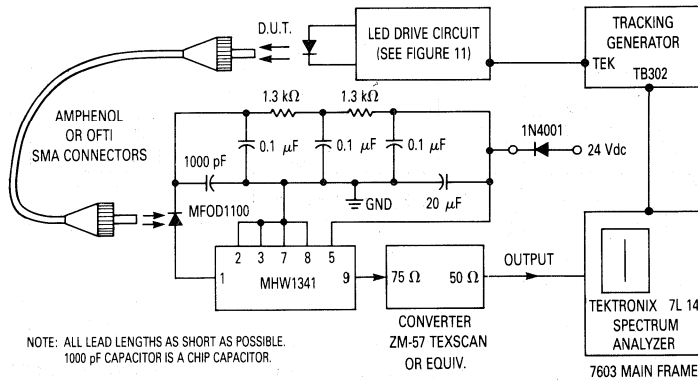
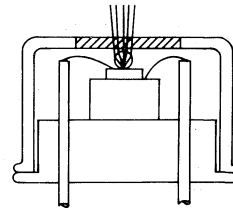

Figure 8. Bandwidth Test Set

| AVERAGE COUPLING EFFICIENCY | | |
|---------------------------------------|--------------------|-------------------------|
| Fiber Core Diameter (μm) | Numerical Aperture | Coupling Efficiency (%) |
| 200 | 0.4 | 28 |
| 100 | 0.29 | 4.5 |
| 85 | 0.26 | 2.6 |
| 62.5 | 0.28 | 1.6 |
| 50 | 0.2 | 0.7 |

Figure 9. Coupling Efficiency



COMPATIBLE WITH AMP #228756-1, AMPHENOL #905-138-5001 AND OFTI # PCR001 RECEPTACLES USING MOTOROLA ALIGNMENT BUSHING MFOA06 (INCLUDED)

Figure 10. Package Cross Section

5

MFOE1201, MFOE1202, MFOE1203

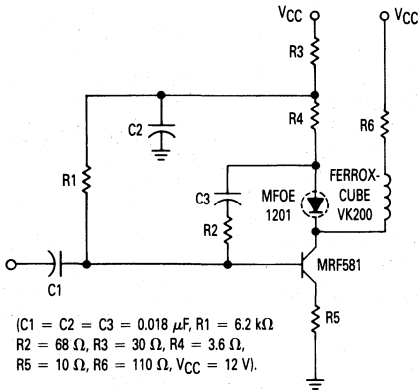

Figure 11. LED Drive Circuit to 100 MHz

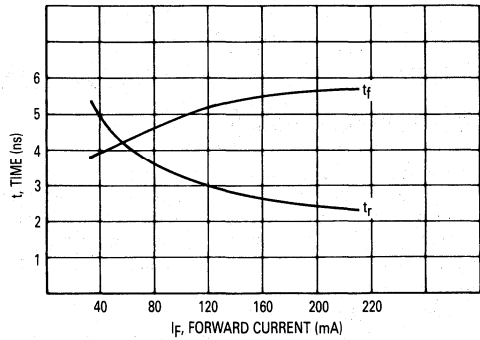

Figure 12. Rise and Fall Time versus Forward Current

OUTLINE DIMENSIONS

STYLE 1:
 PIN 1. - VOUT
 2. + VOUT
 3. GROUND/CASE
 4. + VCC

NOTES:
 1. DIMENSIONS A AND H ARE DATUMS AND T IS A DATUM SURFACE.
 2. LEAD POSITIONAL TOLERANCE AT SEATING PLANE:
 $\pm \Delta 0.036 (0.014) \text{ T } \Delta \text{ A } \Delta \text{ H}$
 3. DIMENSIONING AND TOLERANCING PER Y14.5, 1973.

**CASE 210A-01
 METAL**

| DIM | MILLIMETERS | | INCHES | |
|-----|-------------|------|-----------|-------|
| | MIN | MAX | MIN | MAX |
| A | 5.30 | 5.38 | 0.209 | 0.212 |
| B | 4.64 | 4.69 | 0.183 | 0.185 |
| C | 3.42 | 3.60 | 0.135 | 0.142 |
| D | 0.40 | 0.48 | 0.016 | 0.019 |
| G | 2.54 BSC | | 0.100 BSC | |
| H | 0.91 | 1.16 | 0.036 | 0.046 |
| J | 0.83 | 1.21 | 0.033 | 0.048 |
| K | 12.70 | — | 0.500 | — |
| M | 45° BSC | | 45° BSC | |

Fiber Optics — MOD Family Infrared LED

... designed for fiber optics applications requiring high power and medium-response time. It is spectrally matched to the first window minimum attenuation region of most glass-core fiber optics cables. Motorola's package fits directly into standard fiber optics connector systems. Applications include computer links and industrial controls.

- Medium Response — Digital Data to 40 Mbaud (NRZ) Typ
- Analog Bandwidth — 20 MHz Typ
- Plastic Package — Small, Rugged and Inexpensive
- Internal Lensing Enhances Coupling Efficiency
- Complements All Motorola Fiber Optics Detectors
- Mates snugly with AMP #228756-1, Amphenol #905-138-5001, OFTI #PCR001 Receptacles
- Low Cost

MFOE3100
MFOE3101

MOD FAMILY
FIBER OPTICS
INFRARED LED

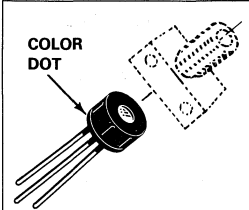

MFOE3100 — RED
MFOE3101 — GREEN

CASE 366-01
PLASTIC

MAXIMUM RATINGS

| Rating | Symbol | Value | Unit |
|--|-----------|---------------|----------------------------|
| Reverse Current | I_R | 1 | mA |
| Forward Current — Continuous | I_F | 60 | mA |
| Total Device Dissipation (at $T_A = 25^\circ\text{C}$ Derate above 25°C) | P_D | 250* 2.63* | mW mW/ $^\circ\text{C}$ |
| Operating Temperature Range | T_J | -40 to +100 | $^\circ\text{C}$ |
| Storage Temperature Range | T_{stg} | -40 to +100 | $^\circ\text{C}$ |

THERMAL CHARACTERISTICS

| Characteristic | Symbol | Max | Unit |
|---|---------------|-------------|---------------------------|
| Thermal Resistance, Junction to Ambient | θ_{JA} | 465 300* | $^\circ\text{C}/\text{W}$ |

ELECTRICAL CHARACTERISTICS ($T_A = 25^\circ\text{C}$)

| Characteristic | Symbol | Min | Typ | Max | Unit |
|---|-------------|-----|-----|-----|-------|
| Reverse Breakdown Voltage ($I_R = 100 \mu\text{A}$) | $V_{(BR)R}$ | 2 | 8 | — | Volts |
| Forward Voltage ($I_F = 50 \text{ mA}$) | V_F | 1.5 | 1.7 | 2 | Volts |
| Total Capacitance ($V_R = 0 \text{ V}$, $f = 1 \text{ MHz}$) | C_T | — | 70 | — | pF |
| LED Bandwidth, Figure 8 ($I_{F[DC]} = 40 \text{ mA}$, $I_{F[MOD]} = 40 \text{ mA p-p}$) | BWE | — | 20 | — | MHz |

*Installed in compatible metal connector housing.

MFOE3100, MFOE3101

OPTICAL CHARACTERISTICS ($T_A = 25^\circ\text{C}$)

| Characteristic | | Symbol | Min | Typ | Max | Unit |
|---|----------------------|-----------|--------------------|-------------|---------------|---------------------------|
| Total Power Output, Figure 2 ($I_F = 50\text{ mA}$, $\lambda \approx 850\text{ nm}$) | MFOE3100 MFOE3101 | P_O | — — | 850 1650 | — — | μW |
| Power Launched, Figure 6 ($I_F = 50\text{ mA}$) | MFOE3100 MFOE3101 | P_L | 10(-20) 50(-13) | — — | — 100(-10) | $\mu\text{W}(\text{dBm})$ |
| Numerical Aperture of Output Port (at -10 dB, 250 μm [10 mil] diameter spot), Figure 10 | | NA | — | 0.3 | — | — |
| Wavelength of Peak Emission @ 50 mAdc | | λ | — | 850 | — | nm |
| Spectral Line Half Width | | — | — | 50 | — | nm |
| Optical Rise and Fall Times, Figure 7 ($I_F = 50\text{ mAdc}$) | | t_r | — | 19 | — | ns |
| | | t_f | — | 14 | — | |

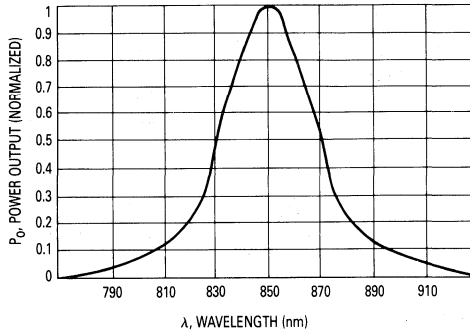

Figure 1. Relative Spectral Output

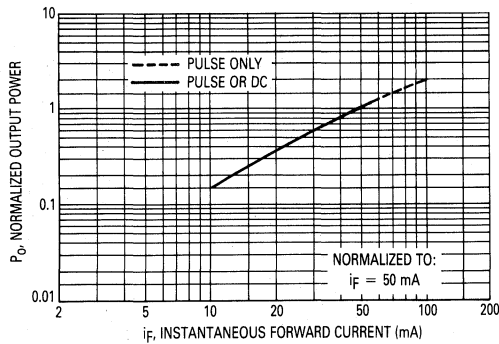

Figure 2. Normalized Output Power versus Forward Current

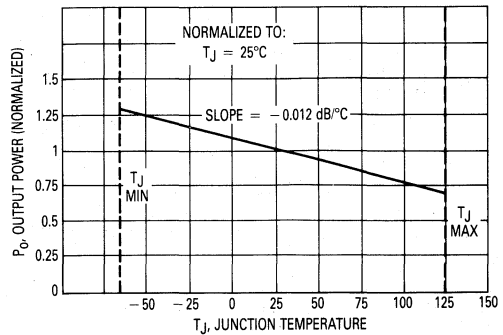

Figure 3. Power Output versus Junction Temperature

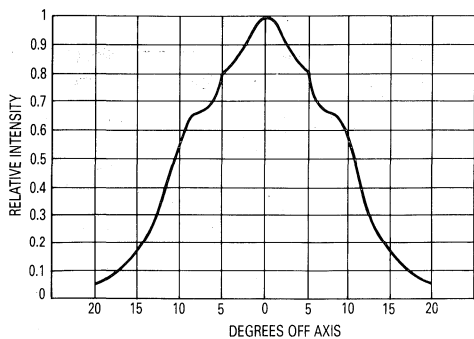

Figure 4. Radial Intensity Distribution

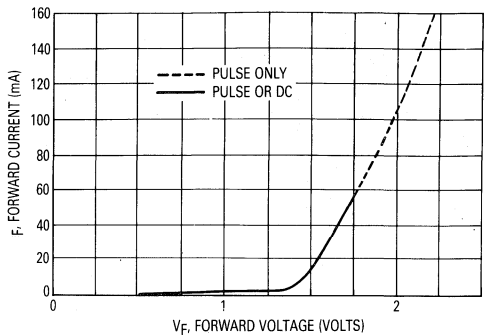

Figure 5. Forward Current versus Forward Voltage

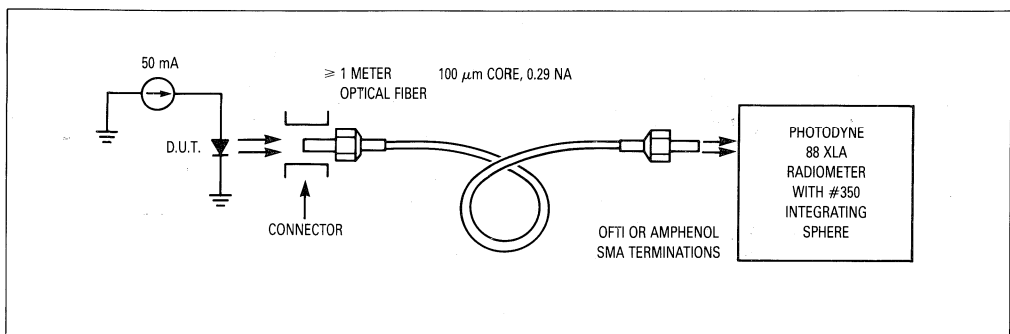

Figure 6. Coupling Efficiency

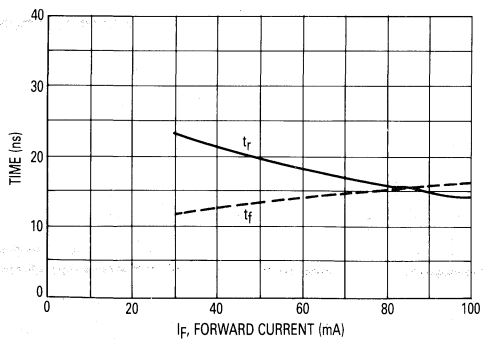

Figure 7. Rise Time and Fall Time versus Forward Current

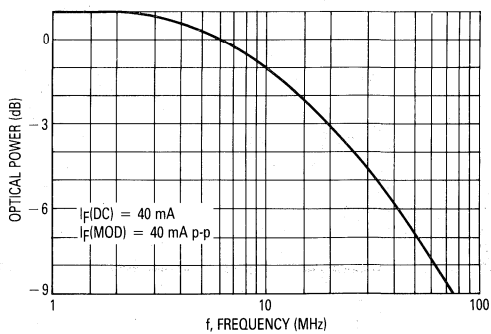
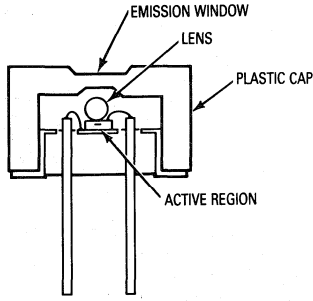

Figure 8. Typical LED Bandwidth

5

MFOE3100, MFOE3101



CAUTION: Avoid contact with the plastic cap by organic solvents. If contaminated, clean with mild detergent and water.

Figure 9. Package Cross Section

| AVERAGE COUPLING EFFICIENCY | | |
|---------------------------------------|--------------------|-------------------------|
| Fiber Core Diameter (μm) | Numerical Aperture | Coupling Efficiency (%) |
| 1000 | 0.5 | 67 |
| 200 | 0.4 | 28 |
| 100 | 0.29 | 4.5 |
| 85 | 0.26 | 2.6 |
| 62.5 | 0.28 | 1.6 |
| 50 | 0.2 | 0.7 |

Figure 10. Coupling Efficiency

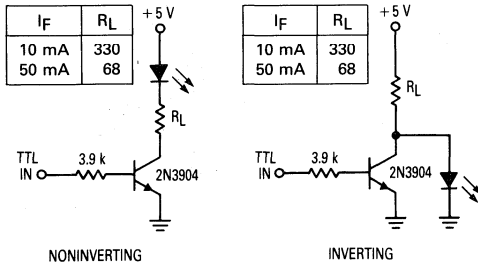

Figure 11. TTL Transmitters

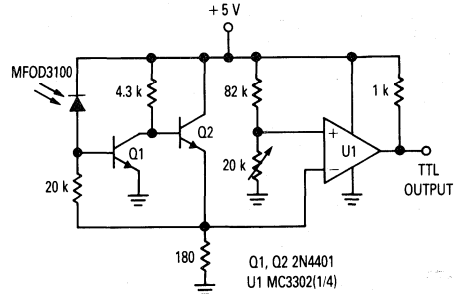

Figure 12. 1 MHz PIN Receiver

OUTLINE DIMENSIONS

NOTES:

- DIMENSION A IS A DATUM AND T IS BOTH A SEATING PLANE AND A DATUM.
- POSITIONAL TOLERANCE FOR LEADS:
 $\pm 0.036 (0.014) \text{ } \textcircled{T} \text{ } \textcircled{A} \text{ } \textcircled{\text{}}$
- DIMENSIONING AND TOLERANCING PER ANSI Y14.5M, 1982.
- CONTROLLING DIMENSION: INCH.

| DIM | MILLIMETERS | | INCHES | |
|-----|-------------|-------|-----------|--------|
| | MIN | MAX | MIN | MAX |
| A | 5.44 | 5.51 | 0.214 | 0.217 |
| B | 5.31 | 5.38 | 0.209 | 0.212 |
| C | 3.683 | 3.848 | 0.1450 | 0.1515 |
| D | 0.406 | 0.470 | 0.0160 | 0.0095 |
| E | 0.178 | 0.241 | 0.0070 | 0.0095 |
| G | 2.54 BSC | | 0.100 BSC | |
| K | 12.70 | 14.22 | 0.500 | 0.560 |
| M | 50° | | 50° | |
| R | 0.13 | 0.25 | 0.005 | 0.010 |
| U | 0.05 | 0.08 | 0.002 | 0.003 |
| V | 1.27 | 1.52 | 0.050 | 0.060 |

STYLE 1:
PIN 1. ANODE
2. CATHODE
3. ANODE

**CASE 366-01
PLASTIC**

Fiber Optics — MOD Family Infrared LED

... designed for fiber optics applications requiring high power and fast response time. It is spectrally matched to the first window minimum attenuation region of most glass-core fiber optics cables. Motorola's package fits directly into standard fiber optics connector systems. Applications include CATV, computer and graphics systems, industrial controls and others.

- Fast Response — Digital Data to 200 Mbaud (NRZ)
- Guaranteed 60 MHz Analog Bandwidth
- Plastic Package — Small, Rugged and Inexpensive
- Internal Lensing Enhances Coupling Efficiency
- Complements All Motorola Fiber Optics Detectors
- Mates snugly with AMP #228756-1, Amphenol #905-138-5001, OFTI #PCR001 Receptacles
- Low Cost

MFOE3200
MFOE3201
MFOE3202

MOD FAMILY
FIBER OPTICS
INFRARED LED

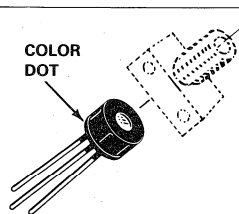

MFOE3200 — BROWN
 MFOE3201 — GRAY
 MFOE3202 — YELLOW

CASE 366-01
 PLASTIC

MAXIMUM RATINGS

| Rating | Symbol | Value | Unit |
|--|-----------|--------------|-------------|
| Reverse Current | I_R | 1 | mA |
| Forward Current — Continuous | I_F | 60 | mA |
| Total Device Dissipation ($T_A = 25^\circ\text{C}$ Derate above 25°C) | P_D | 250 2.63* | mW mW/°C |
| Operating Temperature Range | T_A | -40 to +100 | °C |
| Storage Temperature Range | T_{stg} | -40 to +100 | °C |

THERMAL CHARACTERISTICS

| | | | |
|---|---------------|-------------|------|
| Thermal Resistance, Junction to Ambient | θ_{JA} | 465 300* | °C/W |
|---|---------------|-------------|------|

ELECTRICAL CHARACTERISTICS ($T_A = 25^\circ\text{C}$)

| Characteristic | Symbol | Min | Typ | Max | Unit |
|---|-------------|-----|-----|-----|-------|
| Reverse Breakdown Voltage ($I_R = 100 \mu\text{A}$) | $V_{(BR)R}$ | 2 | 4 | — | Volts |
| Forward Voltage ($I_F = 50 \text{ mA}$) | V_F | 1.5 | 1.9 | 2.2 | Volts |
| Total Capacitance ($V_R = 0 \text{ V}$, $f = 1 \text{ MHz}$) | C_T | — | 70 | — | pF |
| Electrical Bandwidth, Figure 8 ($I_F = 40 \text{ mA dc}$, 50% depth of modulation) | BWE | 60 | 90 | — | MHz |

*Installed in compatible metal connector housing.

5

MFOE3200, MFOE3201, MFOE3202

OPTICAL CHARACTERISTICS ($T_A = 25^\circ\text{C}$)

| Characteristic | | Symbol | Min | Typ | Max | Unit |
|--|----------|-----------|---------|------------|---------|---------------------------|
| Total Power Output, Figure 2 ($I_F = 50\text{ mA}$, $\lambda \approx 850\text{ nm}$) | MFOE3200 | P_O | — | 1000(0) | — | $\mu\text{W}(\text{dBm})$ |
| | MFOE3201 | | — | 1800(2.55) | — | |
| | MFOE3202 | | — | 2500(4.0) | — | |
| Power Launched, Figure 6 ($I_F = 50\text{ mA}$) | MFOE3200 | P_L | 10(-20) | — | — | $\mu\text{W}(\text{dBm})$ |
| | MFOE3201 | | 20(-17) | — | 40(-14) | |
| | MFOE3202 | | 35(-15) | — | 70(-12) | |
| Numerical Aperture of Output Port (at -10 dB) (250 μm [10 mil] diameter spot), Figure 10 | | NA | — | 0.3 | — | — |
| Wavelength of Peak Emission @ 50 mAdc | | λ | — | 850 | — | nm |
| Spectral Line Half Width | | — | — | 50 | — | nm |
| Optical Rise and Fall Times, Figure 7 ($I_F = 50\text{ mAdc}$) | | t_r | — | 2.8 | 4 | ns |
| | | t_f | — | 3.5 | 6 | |

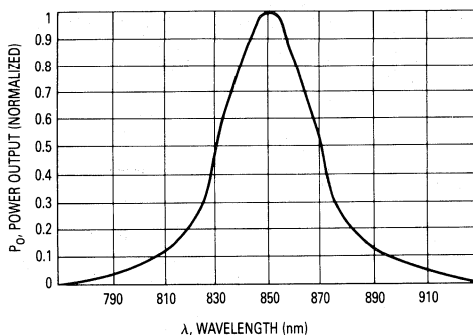

Figure 1. Relative Spectral Output

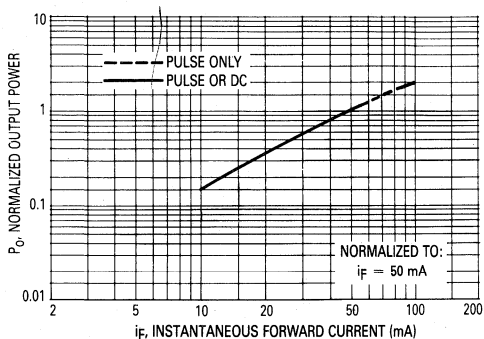

Figure 2. Normalized Output Power versus Forward Current

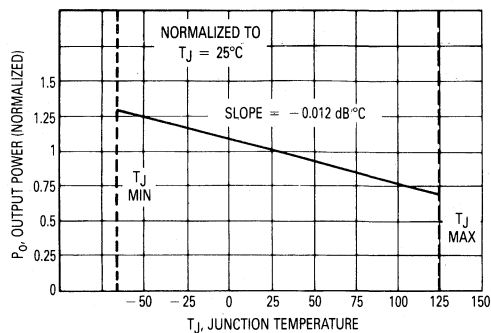

Figure 3. Power Output versus Junction Temperature

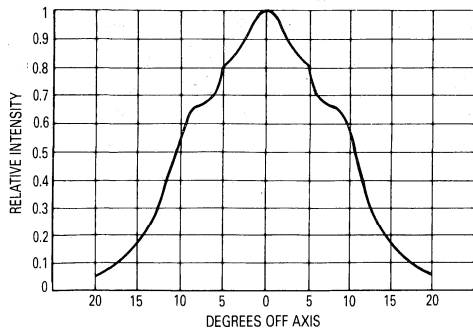

Figure 4. Radial Intensity Distribution

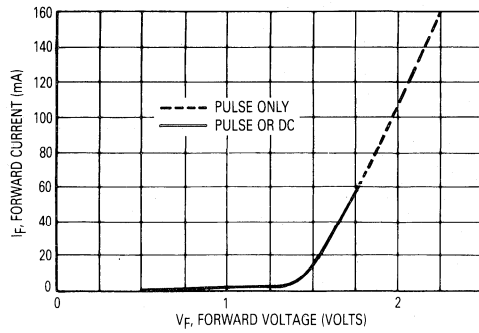

Figure 5. Forward Current versus Forward Voltage

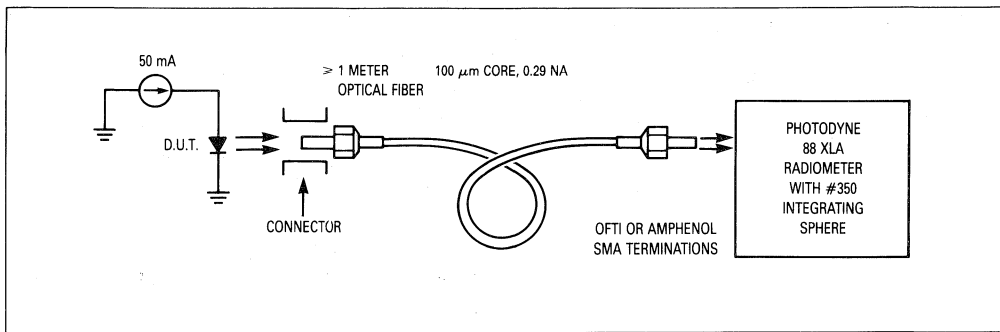

Figure 6. Coupling Efficiency

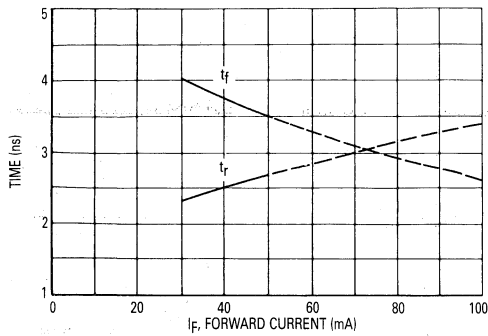

Figure 7. Rise Time (t_r) and Fall Time (t_f) versus Forward Current (I_f)

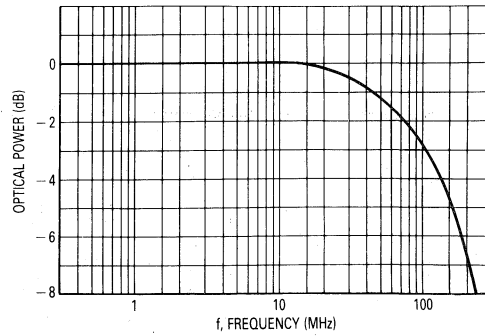

Figure 8. Typical LED Bandwidth

5

MFOE3200, MFOE3201, MFOE3202

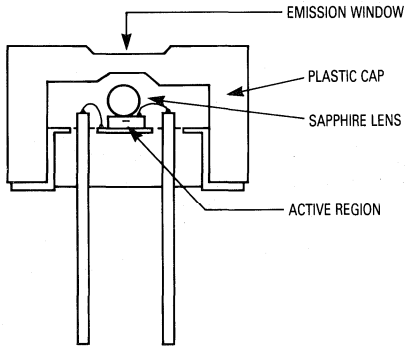
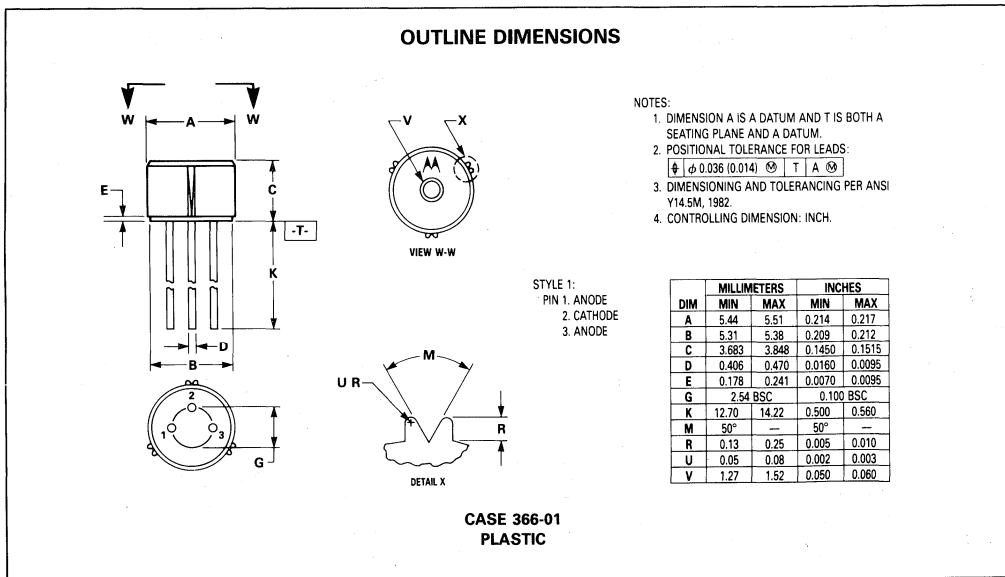

Figure 9. Package Cross Section

| AVERAGE COUPLING EFFICIENCY | | |
|---------------------------------------|--------------------|-------------------------|
| Fiber Core Diameter (μm) | Numerical Aperture | Coupling Efficiency (%) |
| 1000 | 0.5 | 67 |
| 200 | 0.4 | 28 |
| 100 | 0.29 | 4.5 |
| 85 | 0.26 | 2.6 |
| 62.5 | 0.28 | 1.6 |
| 50 | 0.2 | 0.7 |

Figure 10. Coupling Efficiency



5

APPLICATION CIRCUITS

ANALOG

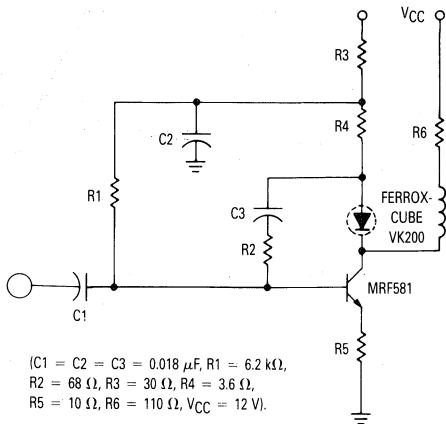
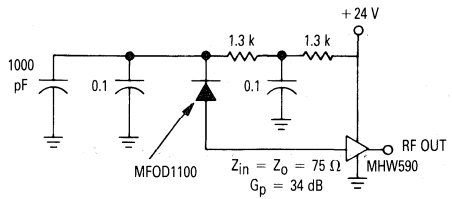
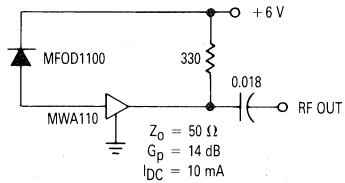

Figure 11. LED Drive Circuit to 100 MHz



A



B

Figure 12. Receiver Circuits

5

DIGITAL

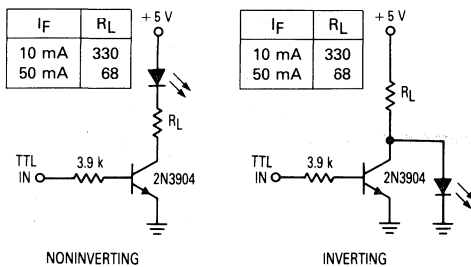

Figure 13. TTL Transmitters

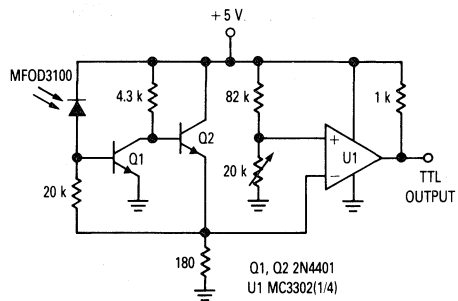
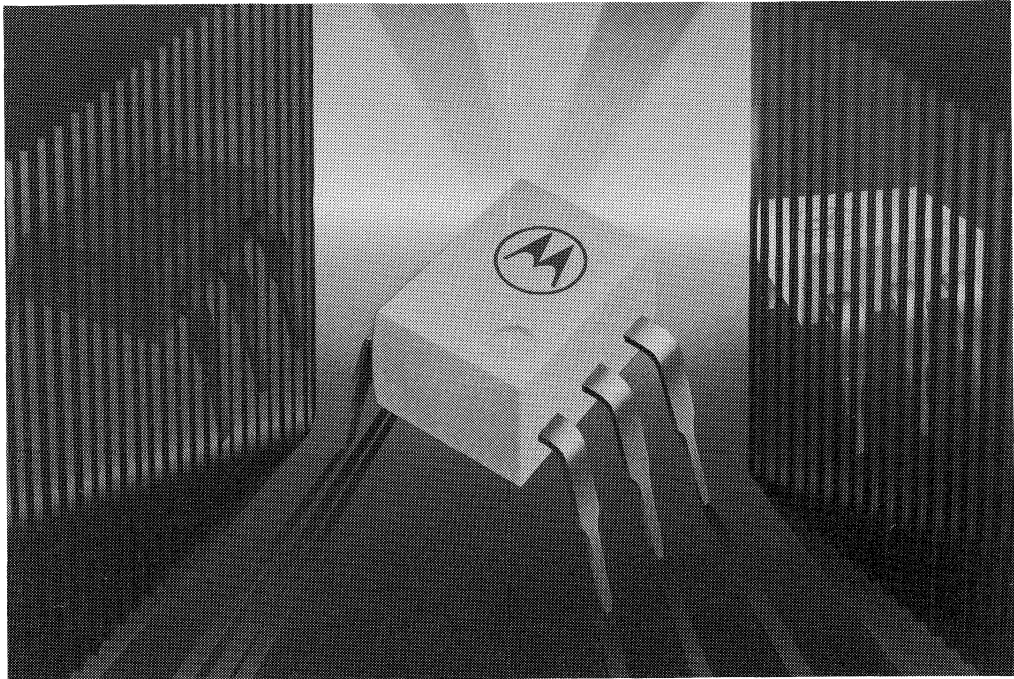

Figure 14. 1 MHz Pin Receiver





Optoisolators/Optocouplers Data Sheets

6

6-Pin DIP Optoisolators Transistor Output

These devices consist of a gallium arsenide infrared emitting diode optically coupled to a monolithic silicon phototransistor detector.

- Convenient Plastic Dual-in-Line Package
- Most Economical Optoisolator
- High Input-Output Isolation Guaranteed — 7500 Volts Peak
- Meets or Exceeds All JEDEC Registered Specifications
- UL Recognized. File Number E54915 
- VDE approved per standard 0883/6.80 (Certificate number 41853), with additional approval to DIN IEC380/VDE0806, IEC435/VDE0805, IEC65/VDE0860, VDE110b, covering all other standards with equal or less stringent requirements, including IEC204/883 VDE0113, VDE0160, VDE0832, VDE0833, etc.
- Special lead form available (add suffix "T" to part number) which satisfies VDE0883/6.80 requirement for 8 mm minimum creepage distance between input and output solder pads.
- Various lead form options available. Consult "Optoisolator Lead Form Options" data sheet for details.

MAXIMUM RATINGS ($T_A = 25^\circ\text{C}$ unless otherwise noted)

| Rating | Symbol | Value | Unit |
|--------|--------|-------|------|
|--------|--------|-------|------|

INPUT LED

| | | | |
|--|-------|------|----------------------|
| Reverse Voltage | V_R | 3 | Volts |
| Forward Current — Continuous | I_F | 60 | mA |
| LED Power Dissipation @ $T_A = 25^\circ\text{C}$ with Negligible Power in Output Detector | P_D | 120 | mW |
| Derate above 25°C | | 1.41 | mW/ $^\circ\text{C}$ |

OUTPUT TRANSISTOR

| | | | |
|---|-----------|------|----------------------|
| Collector-Emitter Voltage | V_{CEO} | 30 | Volts |
| Emitter-Collector Voltage | V_{ECO} | 7 | Volts |
| Collector-Base Voltage | V_{CBO} | 70 | Volts |
| Collector Current — Continuous | I_C | 150 | mA |
| Detector Power Dissipation @ $T_A = 25^\circ\text{C}$ with Negligible Power in Input LED | P_D | 150 | mW |
| Derate above 25°C | | 1.76 | mW/ $^\circ\text{C}$ |

TOTAL DEVICE

| | | | |
|--|-----------|-------------|----------------------------|
| Isolation Surge Voltage (1) (Peak ac Voltage, 60 Hz, 1 sec Duration) | V_{ISO} | 7500 | Vac |
| Total Device Power Dissipation @ $T_A = 25^\circ\text{C}$ Derate above 25°C | P_D | 250 2.94 | mW mW/ $^\circ\text{C}$ |
| Ambient Operating Temperature Range | T_A | -55 to +100 | $^\circ\text{C}$ |
| Storage Temperature Range | T_{stg} | -55 to +150 | $^\circ\text{C}$ |
| Soldering Temperature (10 sec, 1/16" from case) | T_{sol} | 260 | $^\circ\text{C}$ |

(1) Isolation surge voltage is an internal device dielectric breakdown rating. For this test, Pins 1 and 2 are common, and Pins 4, 5 and 6 are common.

4N25
4N25A
4N26
4N27
4N28

**6-PIN DIP
 OPTOISOLATORS
 TRANSISTOR OUTPUT**

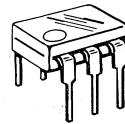

**CASE 730A-02
 PLASTIC**

SCHEMATIC

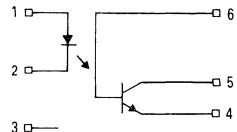

1. LED ANODE
2. LED CATHODE
3. N.C.
4. EMITTER
5. COLLECTOR
6. BASE

4N25, 4N25A, 4N26, 4N27, 4N28

ELECTRICAL CHARACTERISTICS (T_A = 25°C unless otherwise noted)

| Characteristic | Symbol | Min | Typ | Max | Unit |
|--|------------------------|-----|------|-----|-------|
| INPUT LED | | | | | |
| Forward Voltage (I _F = 10 mA) | T _A = 25°C | — | 1.15 | 1.5 | Volts |
| | T _A = -55°C | — | 1.3 | — | |
| | T _A = 100°C | — | 1.05 | — | |
| Reverse Leakage Current (V _R = 3 V) | I _R | — | — | 100 | μA |
| Capacitance (V = 0 V, f = 1 MHz) | C _J | — | 18 | — | pF |

OUTPUT TRANSISTOR

| | | | | | | |
|---|----------------|----------------------|----|-----|-----|-------|
| Collector-Emitter Dark Current (V _{CE} = 10 V, T _A = 25°C) | 4N25,25A,26,27 | I _{CEO} | — | 1 | 50 | nA |
| | 4N28 | I _{CEO} | — | 1 | 100 | |
| (V _{CE} = 10 V, T _A = 100°C) | All Devices | I _{CEO} | — | 1 | — | μA |
| Collector-Base Dark Current (V _{CB} = 10 V) | | I _{CBO} | — | 0.2 | — | nA |
| Collector-Emitter Breakdown Voltage (I _C = 1 mA) | | V _{(BR)CEO} | 30 | 45 | — | Volts |
| Collector-Base Breakdown Voltage (I _C = 100 μA) | | V _{(BR)CBO} | 70 | 100 | — | Volts |
| Emitter-Collector Breakdown Voltage (I _E = 100 μA) | | V _{(BR)ECO} | 7 | 7.8 | — | Volts |
| DC Current Gain (I _C = 2 mA, V _{CE} = 5 V) | | h _{FE} | — | 500 | — | — |
| Collector-Emitter Capacitance (f = 1 MHz, V _{CE} = 0) | | C _{CE} | — | 7 | — | pF |
| Collector-Base Capacitance (f = 1 MHz, V _{CB} = 0) | | C _{CB} | — | 19 | — | pF |
| Emitter-Base Capacitance (f = 1 MHz, V _{EB} = 0) | | C _{EB} | — | 9 | — | pF |

COUPLED

| | | | | | |
|--|----------------------|------------------|------|-----|---------|
| Output Collector Current (I _F = 10 mA, V _{CE} = 10 V) | I _C | 2 | 7 | — | mA |
| 4N25,25A,26 4N27,28 | I _C | 1 | 5 | — | |
| Collector-Emitter Saturation Voltage (I _C = 2 mA, I _F = 50 mA) | V _{CE(sat)} | — | 0.15 | 0.5 | Volts |
| Turn-On Time (I _F = 10 mA, V _{CC} = 10 V, R _L = 100 Ω) | t _{on} | — | 2.8 | — | μs |
| Turn-Off Time (I _F = 10 mA, V _{CC} = 10 V, R _L = 100 Ω) | t _{off} | — | 4.5 | — | μs |
| Rise Time (I _F = 10 mA, V _{CC} = 10 V, R _L = 100 Ω) | t _r | — | 1.2 | — | μs |
| Fall Time (I _F = 10 mA, V _{CC} = 10 V, R _L = 100 Ω) | t _f | — | 1.3 | — | μs |
| Isolation Voltage (f = 60 Hz, t = 1 sec) | V _{ISO} | 7500 | — | — | Vac(pk) |
| Isolation Resistance (V = 500 V) | R _{ISO} | 10 ¹¹ | — | — | Ω |
| Isolation Capacitance (V = 0 V, f = 1 MHz) | C _{ISO} | — | 0.2 | — | pF |

TYPICAL CHARACTERISTICS

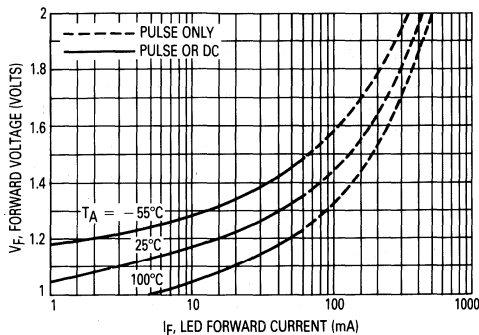

Figure 1. LED Forward Voltage versus Forward Current

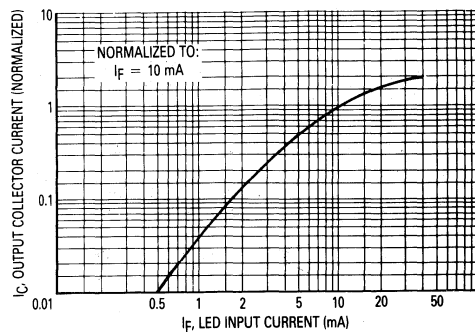

Figure 2. Output Current versus Input Current

4N25, 4N25A, 4N26, 4N27, 4N28

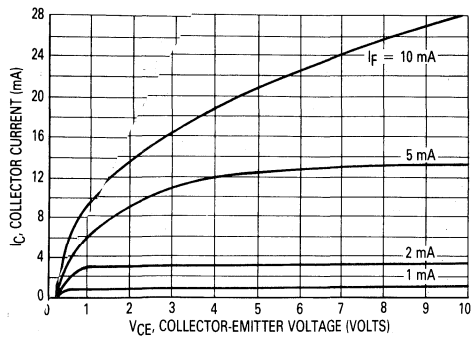

Figure 3. Collector Current versus Collector-Emitter Voltage

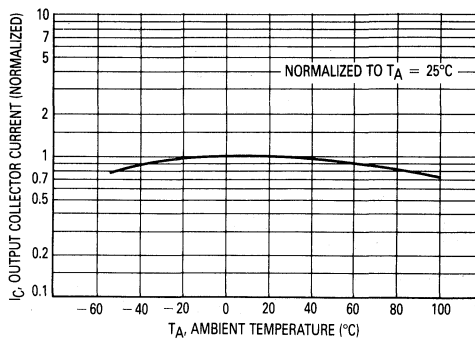

Figure 4. Output Current versus Ambient Temperature

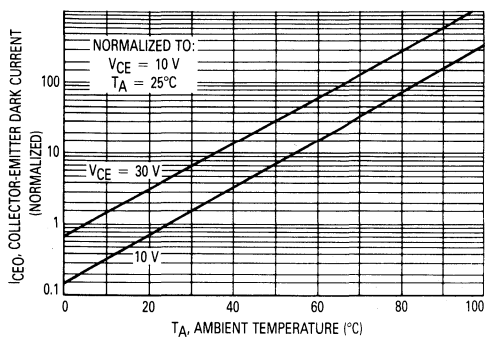

Figure 5. Dark Current versus Ambient Temperature

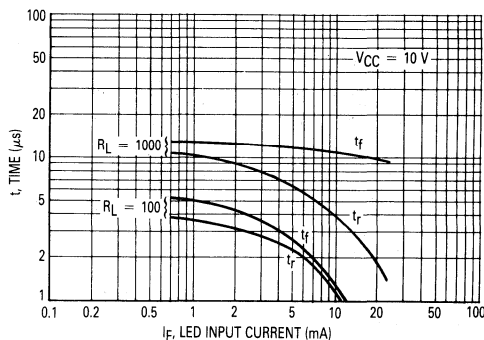

Figure 6. Rise and Fall Times

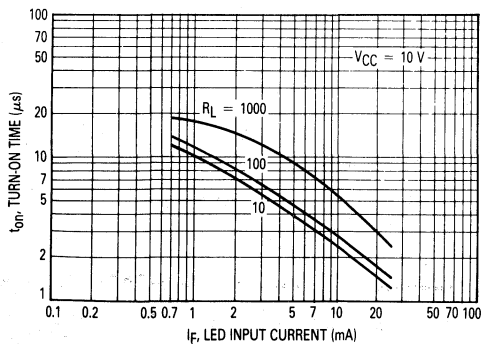

Figure 7. Turn-On Switching Times

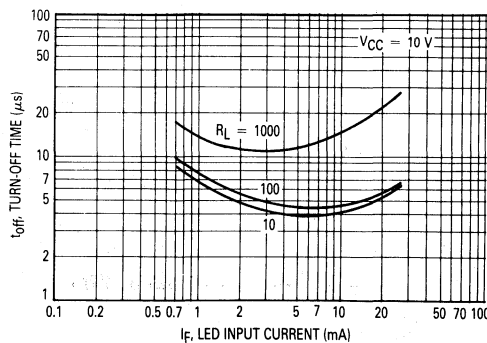

Figure 8. Turn-Off Switching Times

6

4N25, 4N25A, 4N26, 4N27, 4N28

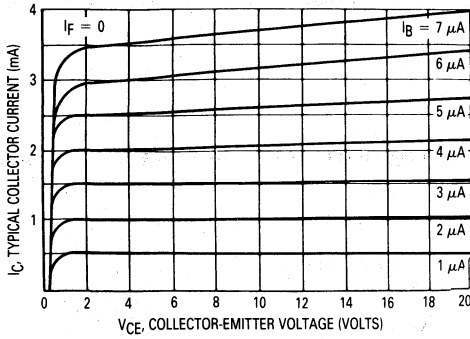

Figure 9. DC Current Gain (Detector Only)

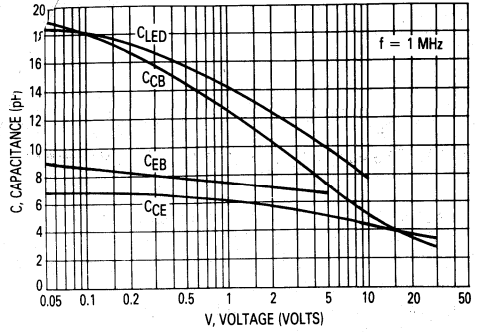

Figure 10. Capacitances versus Voltage

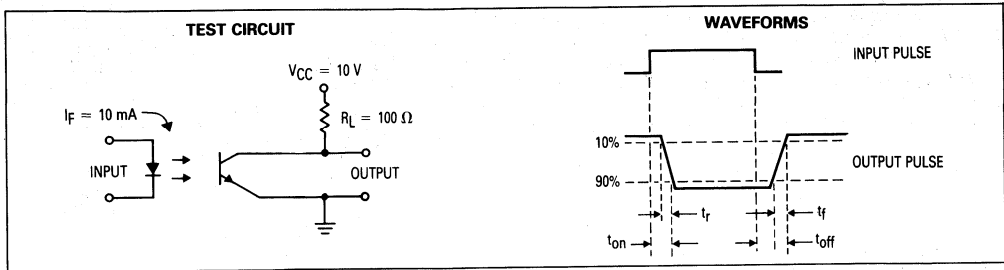
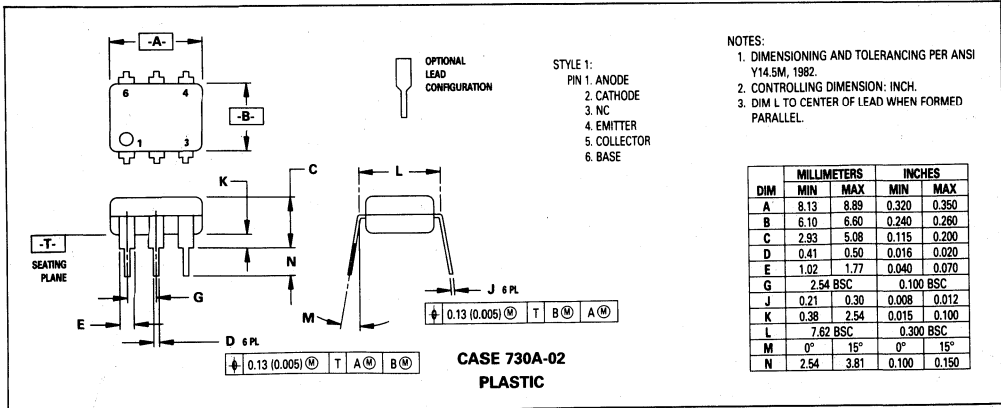

Figure 11. Switching Times



OUTLINE DIMENSIONS



6-Pin DIP Optoisolators Darlington Output

Each device consists of a gallium arsenide infrared emitting diode optically coupled to a monolithic silicon photodarlington detector.

It is designed for use in applications requiring high sensitivity at low input currents.

- Convenient Plastic Dual-In-Line Package
- High Sensitivity to Low Input Drive Current
- High Input-Output Isolation Guaranteed — 7500 Volts Peak
- UL Recognized. File Number E54915 
- VDE approved per standard 0883/6.80 (Certificate number 41853), with additional approval to IEC380/VDE0806, IEC435/VDE0805, IEC65/VDE0860, VDE0110b, covering all other standards with equal or less stringent requirements, including IEC204/VDE0113, VDE0160, VDE0832, VDE0833, etc. 
- Special lead form available (add suffix "T" to part number) which satisfies VDE0883/6.80 requirement for 8 mm minimum creepage distance between input and output solder pads.
- Various lead form options available. Consult "Optoisolator Lead Form Options" data sheet for details.

4N29
4N29A
4N30
4N31
4N32
4N32A
4N33

**6-PIN DIP
 OPTOISOLATORS
 DARLINGTON
 OUTPUT**



**CASE 730A-02
 PLASTIC**

MAXIMUM RATINGS ($T_A = 25^\circ\text{C}$ unless otherwise noted)

| Rating | Symbol | Value | Unit |
|---|--------|-------------|-------------|
| INPUT LED | | | |
| Reverse Voltage | V_R | 3 | Volts |
| Forward Current — Continuous | I_F | 60 | mA |
| LED Power Dissipation @ $T_A = 25^\circ\text{C}$ Derate above 25°C | P_D | 120 1.41 | mW mW/°C |

OUTPUT DETECTOR

| | | | |
|--|-----------|-------------|-------------|
| Collector-Emitter Voltage | V_{CEO} | 30 | Volts |
| Emitter-Collector Voltage | V_{ECO} | 5 | Volts |
| Collector-Base Voltage | V_{CBO} | 30 | Volts |
| Collector Current — Continuous | I_C | 150 | mA |
| Detector Power Dissipation @ $T_A = 25^\circ\text{C}$ Derate above 25°C | P_D | 150 1.76 | mW mW/°C |

TOTAL DEVICE

| | | | |
|--|-----------|-------------|-------------|
| Isolation Surge Voltage (1) (Peak ac Voltage, 60 Hz, 1 sec Duration) | V_{ISO} | 7500 | Vac |
| Total Device Power Dissipation @ $T_A = 25^\circ\text{C}$ Derate above 25°C | P_D | 250 2.94 | mW mW/°C |
| Ambient Operating Temperature Range | T_A | -55 to +100 | °C |
| Storage Temperature Range | T_{stg} | -55 to +150 | °C |
| Soldering Temperature (10 seconds, 1/16" from case) | — | 260 | °C |

(1) Isolation surge voltage is an internal device dielectric breakdown rating. For this test, Pins 1 and 2 are common, and Pins 4, 5 and 6 are common.

SCHEMATIC

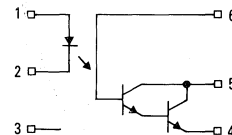

1. LED ANODE
2. LED CATHODE
3. N.C.
4. EMITTER
5. COLLECTOR
6. BASE

4N29, 4N29A, 4N30, 4N31, 4N32, 4N32A, 4N33

ELECTRICAL CHARACTERISTICS ($T_A = 25^\circ\text{C}$ unless otherwise noted)

| Characteristic | Symbol | Min | Typ | Max | Unit |
|--|--------|-----|------|-----|---------------|
| INPUT LED | | | | | |
| *Reverse Leakage Current ($V_R = 3\text{ V}$, $R_L = 1\text{ M ohms}$) | I_R | — | 0.05 | 100 | μA |
| *Forward Voltage ($I_F = 50\text{ mA}$) | V_F | — | 1.34 | 1.5 | Volts |
| Capacitance ($V_R = 0\text{ V}$, $f = 1\text{ MHz}$) | C | — | 18 | — | pF |

OUTPUT DETECTOR ($T_A = 25^\circ\text{C}$ and $I_F = 0$, unless otherwise noted)

| | | | | | |
|--|---------------|----|-----|-----|-------------|
| *Collector-Emitter Dark Current ($V_{CE} = 10\text{ V}$, Base Open) | I_{CEO} | — | — | 100 | nA |
| *Collector-Base Breakdown Voltage ($I_C = 100\ \mu\text{A}$, $I_E = 0$) | $V_{(BR)CBO}$ | 30 | — | — | Volts |
| *Collector-Emitter Breakdown Voltage ($I_C = 100\ \mu\text{A}$, $I_B = 0$) | $V_{(BR)CEO}$ | 30 | — | — | Volts |
| *Emitter-Collector Breakdown Voltage ($I_E = 100\ \mu\text{A}$, $I_B = 0$) | $V_{(BR)ECO}$ | 5 | — | — | Volts |
| DC Current Gain ($V_{CE} = 5\text{ V}$, $I_C = 500\ \mu\text{A}$) | h_{FE} | — | 16K | — | — |

COUPLED ($T_A = 25^\circ\text{C}$ unless otherwise noted)

| | | | | | | |
|--|----------------------------------|---------------|----------------------|-------------|-------------|---------------|
| *Collector Output Current (1) ($V_{CE} = 10\text{ V}$, $I_F = 10\text{ mA}$, $I_B = 0$) | 4N32, 4N33 4N29, 4N30 4N31 | I_C | 50 10 5 | — — — | — — — | mA |
| Isolation Surge Voltage (2, 3) (60 Hz ac Peak, 1 Second) | *4N29, 4N32 *4N30, 4N31, 4N33 | V_{ISO} | 7500 2500 1500 | — — — | — — — | Volts |
| Isolation Resistance (2) ($V = 500\text{ V}$) | | R_{ISO} | — | 10^{11} | — | Ohms |
| *Collector-Emitter Saturation Voltage (1) ($I_C = 2\text{ mA}$, $I_F = 8\text{ mA}$) | 4N31 4N29, 4N39, 4N32, 4N33 | $V_{CE(sat)}$ | — — | — — | 1.2 1 | Volts |
| Isolation Capacitance (2) ($V = 0\text{ V}$, $f = 1\text{ MHz}$) | | C_{ISO} | — | 0.2 | — | pF |
| Turn-On Time ($I_C = 50\text{ mA}$, $I_F = 200\text{ mA}$, $V_{CC} = 10\text{ V}$) | | t_{on} | — | 0.6 | 5 | μs |
| Turn-Off Time ($I_C = 50\text{ mA}$, $I_F = 200\text{ mA}$, $V_{CC} = 10\text{ V}$) | 4N29, 30, 31 4N32, 33 | t_{off} | — — | 17 45 | 40 100 | μs |

*Indicates JEDEC Registered Data.

(1) Pulse Test: Pulse Width = $300\ \mu\text{s}$, Duty Cycle $\leq 2\%$.

(2) For this test, Pins 1 and 2 are common and Pins 4, 5 and 6 are common.

(3) Isolation Surge Voltage, V_{ISO} , is an internal device dielectric breakdown rating.

TYPICAL CHARACTERISTICS

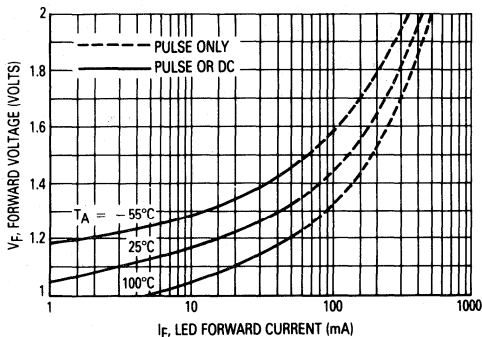

Figure 1. LED Forward Voltage versus Forward Current

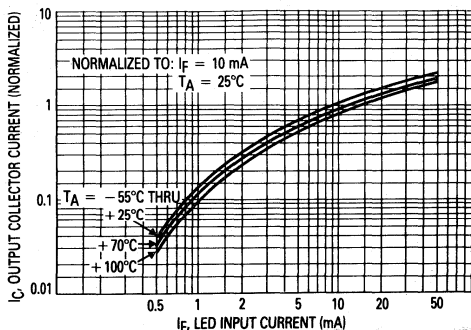

Figure 2. Output Current versus Input Current

4N29, 4N29A, 4N30, 4N31, 4N32, 4N32A, 4N33

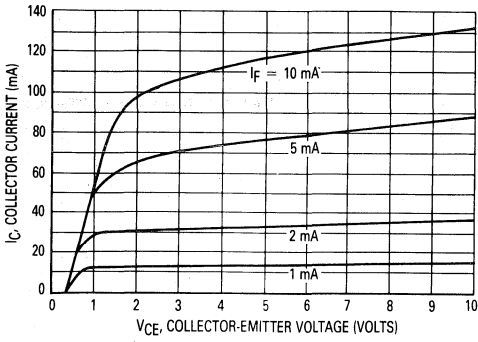

Figure 3. Collector Current versus Collector-Emitter Voltage

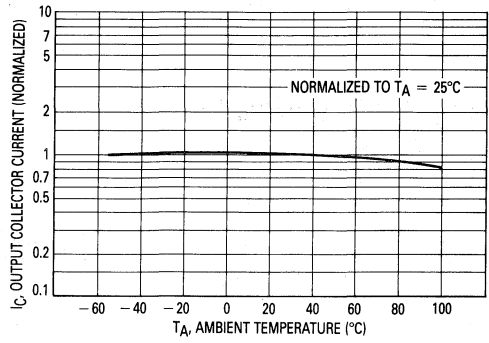

Figure 4. Output Current versus Ambient Temperature

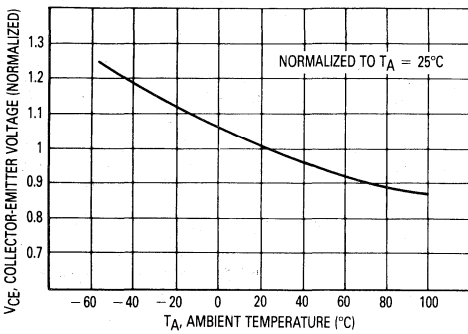

Figure 5. Collector-Emitter Voltage versus Ambient Temperature

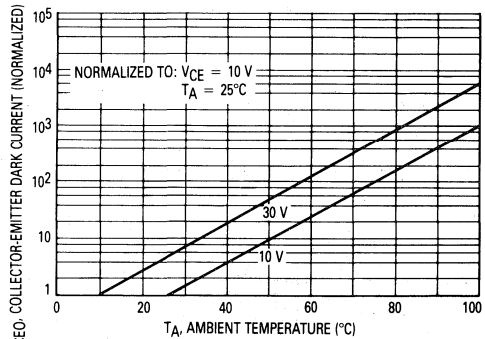

Figure 6. Collector-Emitter Dark Current versus Ambient Temperature

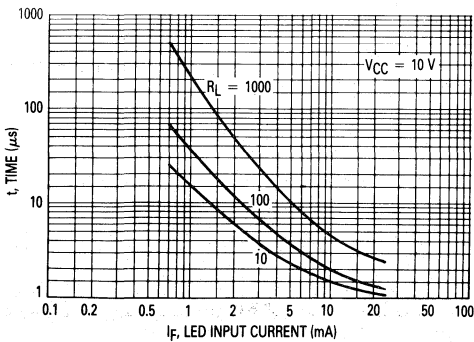

Figure 7. Turn-On Switching Times

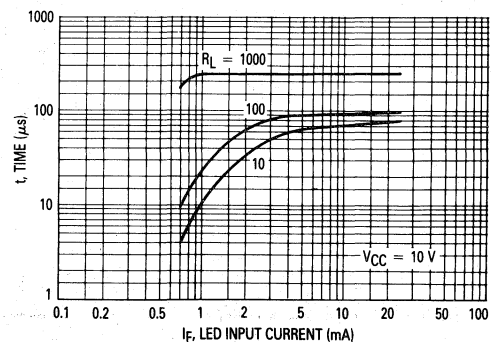

Figure 8. Turn-Off Switching Times

4N29, 4N29A, 4N30, 4N31, 4N32, 4N32A, 4N33

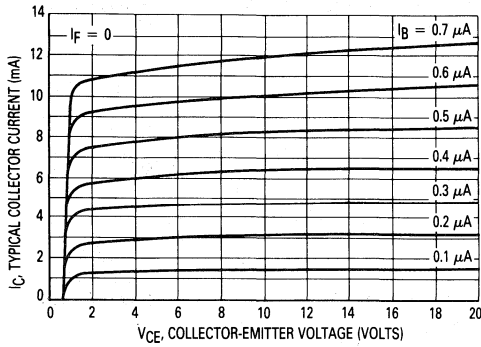

Figure 9. DC Current Gain (Detector Only)

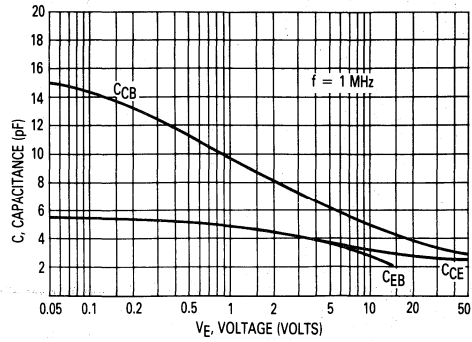

Figure 10. Detector Capacitances versus Voltage

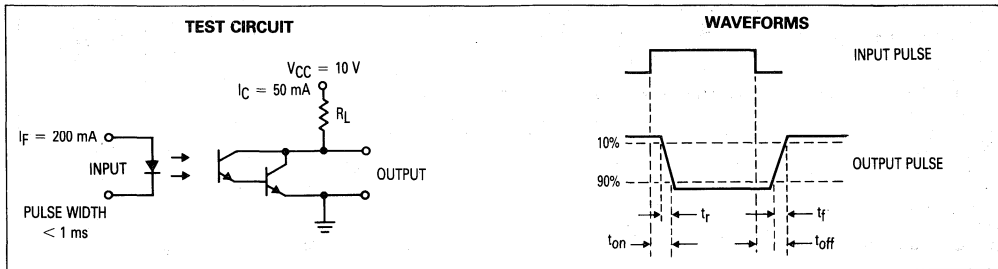
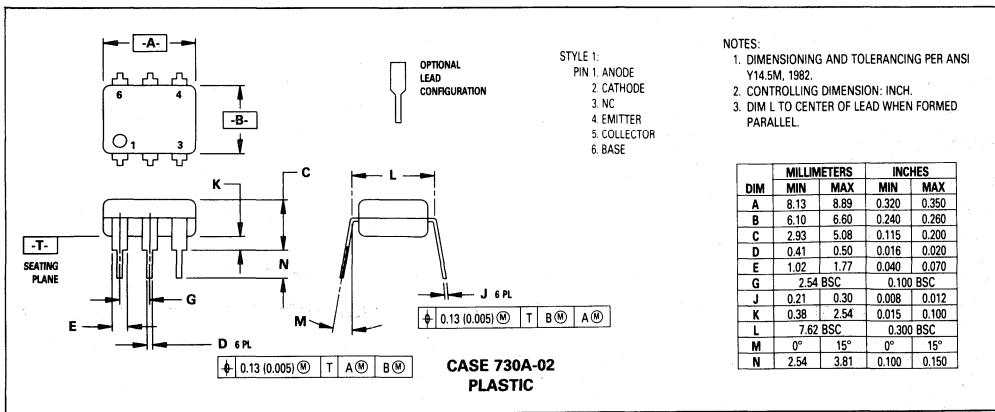



Figure 11. Switching Times

OUTLINE DIMENSIONS



6-Pin DIP Optoisolators Transistor Output

These devices consist of a gallium arsenide infrared emitting diode optically coupled to a monolithic silicon phototransistor detector.

- Convenient Plastic Dual-In-Line Package
- High Current Transfer Ratio — 100% Minimum at Spec Conditions
- Guaranteed Switching Speeds
- High Input-Output Isolation Guaranteed — 7500 Volts Peak
- UL Recognized. File Number E54915 
- VDE approved per standard 0883/6.80 (Certificate number 41853), with additional approval to DIN IEC380/VDE0806, IEC435/VDE0805, IEC65/VDE0860, VDE0110b, covering all other standards with equal or less stringent requirements, including IEC204/VDE0113, VDE0160, VDE0832, VDE0833, etc. 
- Meets or Exceeds All JEDEC Registered Specifications
- Special lead form available (add suffix "T" to part number) which satisfies VDE0883/6.80 requirement for 8 mm minimum creepage distance between input and output solder pads.
- Various lead form options available. Consult "Optoisolator Lead Form Options" data sheet for details.

4N35
4N36
4N37

**6-PIN DIP
 OPTOISOLATORS
 TRANSISTOR
 OUTPUT**

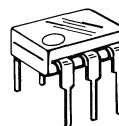

**CASE 730A-02
 PLASTIC**

MAXIMUM RATINGS ($T_A = 25^\circ\text{C}$ unless otherwise noted)

| Rating | Symbol | Value | Unit |
|--------|--------|-------|------|
|--------|--------|-------|------|

INPUT LED

| | | | |
|--|-------|------|----------------------|
| Reverse Voltage | V_R | 6 | Volts |
| Forward Current — Continuous | I_F | 60 | mA |
| LED Power Dissipation @ $T_A = 25^\circ\text{C}$ with Negligible Power in Output Detector | P_D | 120 | mW |
| Derate above 25°C | | 1.41 | mW/ $^\circ\text{C}$ |

OUTPUT TRANSISTOR

| | | | |
|---|-----------|------|----------------------|
| Collector-Emitter Voltage | V_{CEO} | 30 | Volts |
| Emitter-Base Voltage | V_{EBO} | 7 | Volts |
| Collector-Base Voltage | V_{CBO} | 70 | Volts |
| Collector Current — Continuous | I_C | 150 | mA |
| Detector Power Dissipation @ $T_A = 25^\circ\text{C}$ with Negligible Power in Input LED | P_D | 150 | mW |
| Derate above 25°C | | 1.76 | mW/ $^\circ\text{C}$ |

TOTAL DEVICE

| | | | |
|--|-----------|-------------|----------------------------|
| Isolation Source Voltage (1) (Peak ac Voltage, 60 Hz, 1 sec Duration) | V_{ISO} | 7500 | Vac |
| Total Device Power Dissipation @ $T_A = 25^\circ\text{C}$ Derate above 25°C | P_D | 250 2.94 | mW mW/ $^\circ\text{C}$ |
| Ambient Operating Temperature Range | T_A | -55 to +100 | $^\circ\text{C}$ |
| Storage Temperature Range | T_{stg} | -55 to +150 | $^\circ\text{C}$ |
| Soldering Temperature (10 seconds, 1/16" from case) | — | 260 | $^\circ\text{C}$ |

(1) Isolation surge voltage is an internal device dielectric breakdown rating. For this test, Pins 1 and 2 are common, and Pins 4, 5 and 6 are common.

SCHEMATIC

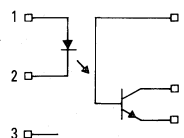

1. LED ANODE
2. LED CATHODE
3. N.C.
4. EMITTER
5. COLLECTOR
6. BASE

4N35, 4N36, 4N37

ELECTRICAL CHARACTERISTICS ($T_A = 25^\circ\text{C}$ unless otherwise noted)

| Characteristic | Symbol | Min | Typ | Max | Unit | |
|---|--|-------|-----|------|------|---------------|
| INPUT LED | | | | | | |
| Forward Voltage ($I_F = 10\text{ mA}$) | $T_A = 25^\circ\text{C}$ $T_A = -55^\circ\text{C}$ $T_A = 100^\circ\text{C}$ | V_F | 0.8 | 1.15 | 1.5 | V |
| | | | 0.9 | 1.3 | 1.7 | |
| | | | 0.7 | 1.05 | 1.4 | |
| Reverse Leakage Current ($V_R = 6\text{ V}$) | | I_R | — | — | 10 | μA |
| Capacitance ($V = 0\text{ V}$, $f = 1\text{ MHz}$) | | C_J | — | 18 | — | pF |

OUTPUT TRANSISTOR

| | | | | | | |
|--|---|-----------|-----|-----|---------------|----|
| Collector-Emitter Dark Current ($V_{CE} = 10\text{ V}$, $T_A = 25^\circ\text{C}$) ($V_{CE} = 30\text{ V}$, $T_A = 100^\circ\text{C}$) | I_{CEO} | — | 1 | 50 | nA | |
| | | — | — | 500 | μA | |
| Collector-Base Dark Current ($V_{CB} = 10\text{ V}$) | $T_A = 25^\circ\text{C}$ $T_A = 100^\circ\text{C}$ | I_{CBO} | — | 0.2 | 20 | nA |
| | | | — | 100 | — | |
| Collector-Emitter Breakdown Voltage ($I_C = 1\text{ mA}$) | $V_{(BR)CEO}$ | 30 | 45 | — | V | |
| Collector-Base Breakdown Voltage ($I_C = 100\text{ }\mu\text{A}$) | $V_{(BR)CBO}$ | 70 | 100 | — | V | |
| Emitter-Base Breakdown Voltage ($I_E = 100\text{ }\mu\text{A}$) | $V_{(BR)EBO}$ | 7 | 7.8 | — | V | |
| DC Current Gain ($I_C = 2\text{ mA}$, $V_{CE} = 5\text{ V}$) | h_{FE} | — | 400 | — | — | |
| Collector-Emitter Capacitance ($f = 1\text{ MHz}$, $V_{CE} = 0$) | C_{CE} | — | 7 | — | pF | |
| Collector-Base Capacitance ($f = 1\text{ MHz}$, $V_{CB} = 0$) | C_{CB} | — | 19 | — | pF | |
| Emitter-Base Capacitance ($f = 1\text{ MHz}$, $V_{EB} = 0$) | C_{EB} | — | 9 | — | pF | |

COUPLED

| | | | | | | |
|---|--|---------------|-----------|------|-----|---------------|
| Output Collector Current ($I_F = 10\text{ mA}$, $V_{CE} = 10\text{ V}$) | $T_A = 25^\circ\text{C}$ $T_A = -55^\circ\text{C}$ $T_A = 100^\circ\text{C}$ | I_C | 10 | 30 | — | mA |
| | | | 4 | — | — | |
| | | | 4 | — | — | |
| Collector-Emitter Saturation Voltage ($I_C = 0.5\text{ mA}$, $I_F = 10\text{ mA}$) | | $V_{CE(sat)}$ | — | 0.14 | 0.3 | V |
| Turn-On Time | $I_C = 2\text{ mA}$, $V_{CC} = 10\text{ V}$, $R_L = 100\text{ }\Omega$, Figure 11) | t_{on} | — | 7.5 | 10 | μs |
| Turn-Off Time | | t_{off} | — | 5.7 | 10 | |
| Rise Time | | t_r | — | 3.2 | — | |
| Fall Time | | t_f | — | 4.7 | — | |
| Isolation Voltage ($f = 60\text{ Hz}$, $t = 1\text{ sec}$) | | V_{ISO} | 7500 | — | — | |
| Isolation Current ($V_{I-O} = 3550\text{ Vpk}$) | 4N35 | I_{ISO} | — | — | 100 | μA |
| ($V_{I-O} = 2500\text{ Vpk}$) | 4N36 | | — | — | 100 | |
| ($V_{I-O} = 1500\text{ Vpk}$) | 4N37 | | — | 8 | 100 | |
| Isolation Resistance ($V = 500\text{ V}$) | | R_{ISO} | 10^{11} | — | — | Ω |
| Isolation Capacitance ($V = 0\text{ V}$, $f = 1\text{ MHz}$) | | C_{ISO} | — | 0.2 | 2 | pF |

TYPICAL CHARACTERISTICS

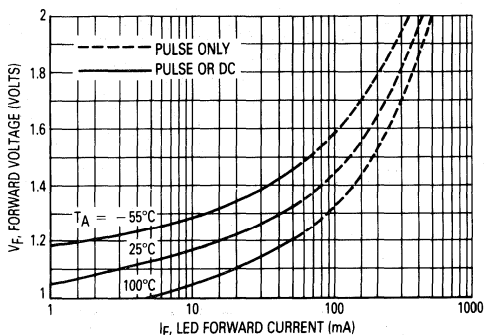

Figure 1. LED Forward Voltage versus Forward Current

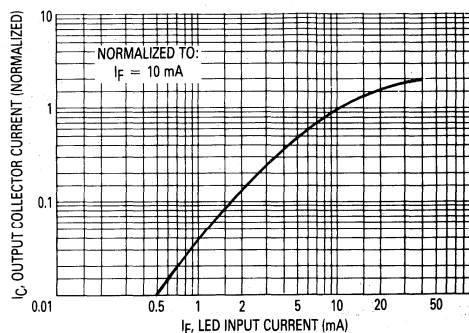

Figure 2. Output Current versus Input Current

4N35, 4N36, 4N37

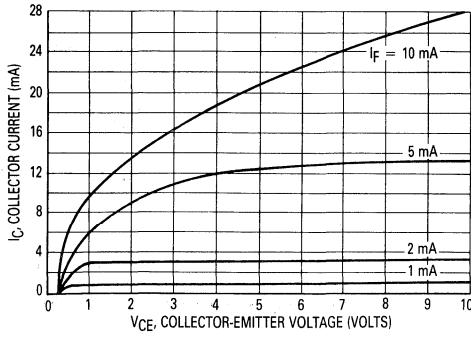

Figure 3. Collector Current versus Collector-Emitter Voltage

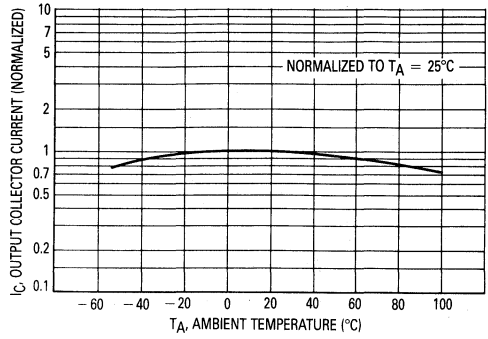

Figure 4. Output Current versus Ambient Temperature

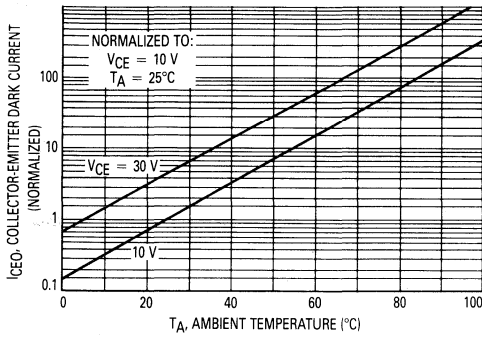

Figure 5. Dark Current versus Ambient Temperature

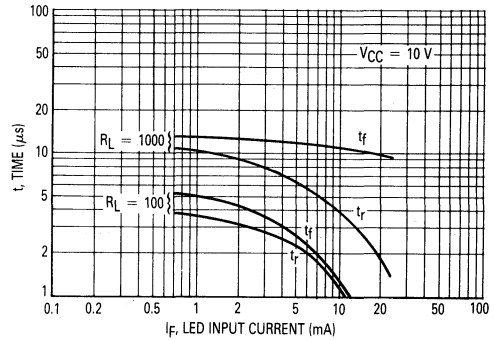

Figure 6. Rise and Fall Times

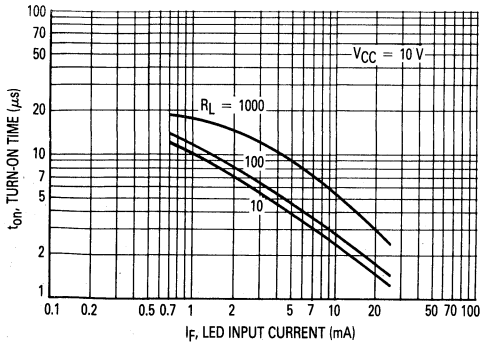

Figure 7. Turn-On Switching Times

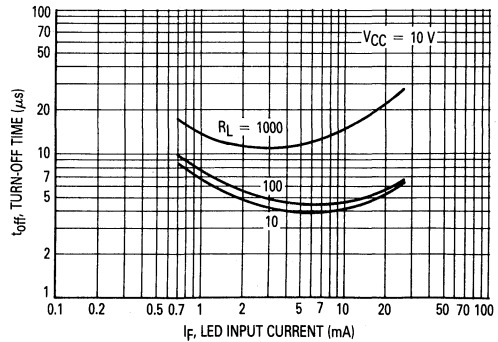

Figure 8. Turn-Off Switching Times



4N35, 4N36, 4N37

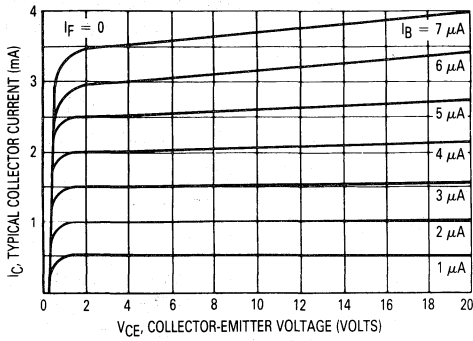

Figure 9. DC Current Gain (Detector Only)

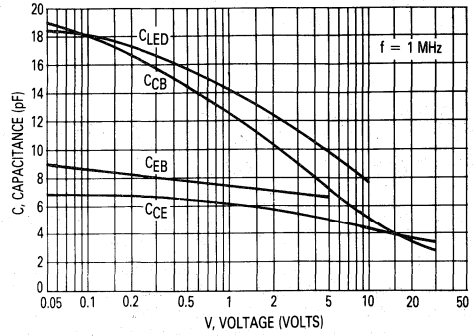

Figure 10. Capacitances versus Voltage

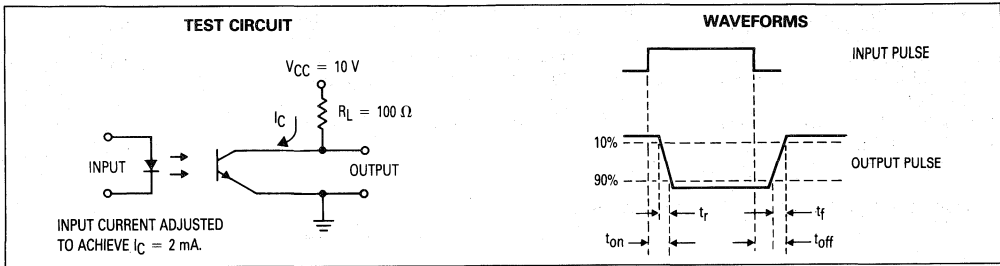
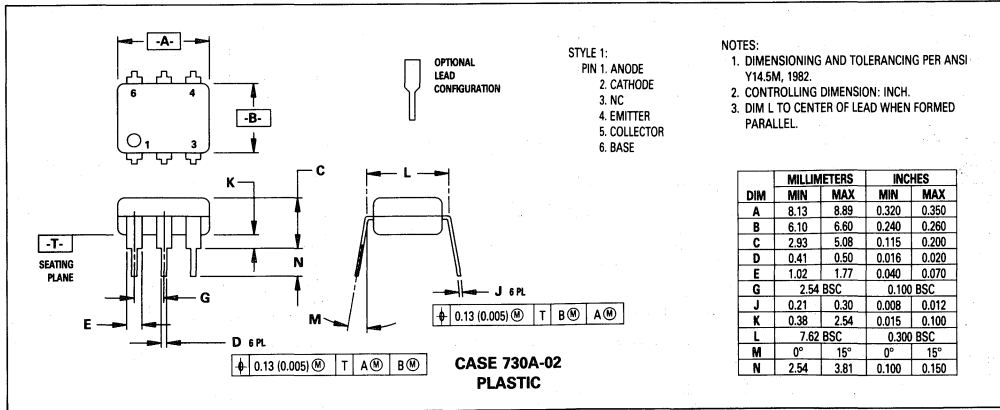



Figure 11. Switching Times

OUTLINE DIMENSIONS



6-Pin DIP Optoisolators Transistor Output

These devices consist of a gallium arsenide infrared emitting diode optically coupled to a monolithic silicon phototransistor detector.

- Convenient Plastic Dual-in-Line Package
- Guaranteed 80 Volt $V_{(BR)CEO}$ Minimum
- High Input-Output Isolation Guaranteed — 7500 Volts Peak
- Meets or Exceeds All JEDEC Registered Specifications
- UL Recognized. (1) File Number E54915 
- VDE approved per standard 0883/6.80 (Certificate number 41853), with additional approval to DIN IEC380/VDE0806, IEC435/VDE0805, IEC65/VDE0860, VDE0110b, covering all other standards with equal or less stringent requirements, including IEC204/VDE0113, VDE0160, VDE0832, VDE0833, etc. 
- Special lead form available (add suffix "T" to part number) which satisfies VDE0883/6.80 requirement for 8 mm minimum creepage distance between input and output solder pads.
- Various lead form options available. Consult "Optoisolator Lead Form Options" data sheet for details.

MAXIMUM RATINGS ($T_A = 25^\circ\text{C}$ unless otherwise noted)

| Rating | Symbol | Value | Unit |
|--|------------------|-------|----------------------|
| INPUT LED | | | |
| Reverse Voltage | V_R | 3 | Volts |
| Forward Current — Continuous | I_F | 80 | mA |
| Forward Current — Pk (PW = 300 μs , 2% duty cycle) | $I_F(\text{pk})$ | 3 | A |
| LED Power Dissipation @ $T_A = 25^\circ\text{C}$ with Negligible Power in Output Detector | P_D | 150 | mW |
| Derate above 25°C | | 1.41 | mW/ $^\circ\text{C}$ |

OUTPUT TRANSISTOR

| | | | |
|---|-----------|------|----------------------|
| Collector-Emitter Voltage | V_{CEO} | 80 | Volts |
| Emitter-Collector Voltage | V_{ECO} | 7 | Volts |
| Collector-Base Voltage | V_{CBO} | 80 | Volts |
| Collector Current — Continuous | I_C | 100 | mA |
| Detector Power Dissipation @ $T_A = 25^\circ\text{C}$ with Negligible Power in Input LED | P_D | 150 | mW |
| Derate above 25°C | | 1.76 | mW/ $^\circ\text{C}$ |

TOTAL DEVICE

| | | | |
|--|-----------|-------------|----------------------------|
| Isolation Surge Voltage (1) (Peak ac Voltage, 60 Hz, 1 sec Duration) | V_{ISO} | 7500 | Vac |
| Total Device Power Dissipation @ $T_A = 25^\circ\text{C}$ Derate above 25°C | P_D | 250 2.94 | mW mW/ $^\circ\text{C}$ |
| Ambient Operating Temperature Range | T_A | -55 to +100 | $^\circ\text{C}$ |
| Storage Temperature Range | T_{stg} | -55 to +150 | $^\circ\text{C}$ |
| Soldering Temperature (10 sec, 1/16" from case) | T_{sol} | 260 | $^\circ\text{C}$ |

Note: (1) 4N38 does not require UL approval; 4N38A does. Otherwise both parts are identical. Both parts built by Motorola have UL approval.

4N38
4N38A

6-PIN DIP
OPTOISOLATORS
TRANSISTOR OUTPUT



CASE 730A-02
PLASTIC

SCHEMATIC

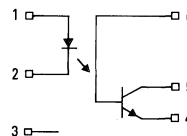

1. LED ANODE
2. LED CATHODE
3. N.C.
4. EMITTER
5. COLLECTOR
6. BASE

4N38, 4N38A

ELECTRICAL CHARACTERISTICS ($T_A = 25^\circ\text{C}$ unless otherwise noted)

| Characteristic | Symbol | Min | Typ | Max | Unit |
|---|---------------------------|-----|------|-----|---------------|
| INPUT LED | | | | | |
| Forward Voltage ($I_F = 10\text{ mA}$) | $T_A = 25^\circ\text{C}$ | — | 1.15 | 1.5 | Volts |
| | $T_A = -55^\circ\text{C}$ | — | 1.3 | — | |
| | $T_A = 100^\circ\text{C}$ | — | 1.05 | — | |
| Reverse Leakage Current ($V_R = 3\text{ V}$) | I_R | — | — | 100 | μA |
| Capacitance ($V = 0\text{ V}$, $f = 1\text{ MHz}$) | C_J | — | 18 | — | pF |

OUTPUT TRANSISTOR

| | | | | | | |
|--|---|---------------|----|-----|----|---------------|
| Collector-Emitter Dark Current | $(V_{CE} = 60\text{ V}, T_A = 25^\circ\text{C})$ | I_{CEO} | — | 20 | 50 | nA |
| | $(V_{CE} = 60\text{ V}, T_A = 100^\circ\text{C})$ | I_{CEO} | — | 6 | — | μA |
| Collector-Base Dark Current ($V_{CB} = 60\text{ V}$) | | I_{CBO} | — | 2 | 20 | nA |
| Collector-Emitter Breakdown Voltage ($I_C = 1\text{ mA}$) | | $V_{(BR)CEO}$ | 80 | 120 | — | Volts |
| Collector-Base Breakdown Voltage ($I_C = 1\text{ }\mu\text{A}$) | | $V_{(BR)CBO}$ | 80 | 120 | — | Volts |
| Emitter-Collector Breakdown Voltage ($I_E = 100\text{ }\mu\text{A}$) | | $V_{(BR)ECO}$ | 7 | 7.8 | — | Volts |
| DC Current Gain ($I_C = 2\text{ mA}$, $V_{CE} = 5\text{ V}$) | | h_{FE} | — | 400 | — | — |
| Collector-Emitter Capacitance ($f = 1\text{ MHz}$, $V_{CE} = 0$) | | C_{CE} | — | 8 | — | pF |
| Collector-Base Capacitance ($f = 1\text{ MHz}$, $V_{CB} = 0$) | | C_{CB} | — | 21 | — | pF |
| Emitter-Base Capacitance ($f = 1\text{ MHz}$, $V_{EB} = 0$) | | C_{EB} | — | 8 | — | pF |

COUPLED

| | | | | | |
|---|---------------|-----------|-----|---|---------------|
| Output Collector Current ($I_F = 20\text{ mA}$, $V_{CE} = 1\text{ V}$) | I_C | 4 | 7 | — | mA |
| Collector-Emitter Saturation Voltage ($I_C = 4\text{ mA}$, $I_F = 20\text{ mA}$) | $V_{CE(sat)}$ | — | — | 1 | Volts |
| Turn-On Time ($I_C = 2\text{ mA}$, $V_{CC} = 10\text{ V}$, $R_L = 100\text{ }\Omega$, Figure 11) | t_{on} | — | 3 | — | μs |
| Turn-Off Time ($I_C = 2\text{ mA}$, $V_{CC} = 10\text{ V}$, $R_L = 100\text{ }\Omega$, Figure 11) | t_{off} | — | 2.8 | — | μs |
| Rise Time ($I_C = 2\text{ mA}$, $V_{CC} = 10\text{ V}$, $R_L = 100\text{ }\Omega$, Figure 11) | t_r | — | 1.6 | — | μs |
| Fall Time ($I_C = 2\text{ mA}$, $V_{CC} = 10\text{ V}$, $R_L = 100\text{ }\Omega$, Figure 11) | t_f | — | 2.2 | — | μs |
| Isolation Voltage ($f = 60\text{ Hz}$, $t = 1\text{ sec}$) | V_{ISO} | 7500 | — | — | Vac(pk) |
| Isolation Resistance ($V = 500\text{ V}$) | R_{ISO} | 10^{11} | — | — | Ω |
| Isolation Capacitance ($V = 0\text{ V}$, $f = 1\text{ MHz}$) | C_{ISO} | — | 0.2 | — | pF |

TYPICAL CHARACTERISTICS

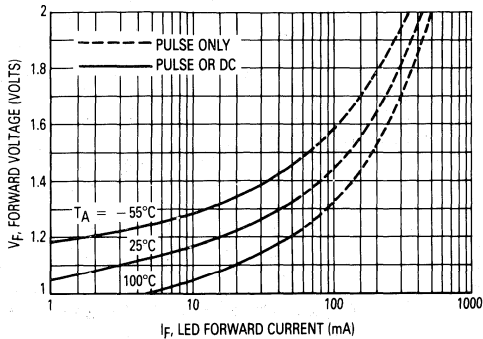

Figure 1. LED Forward Voltage versus Forward Current

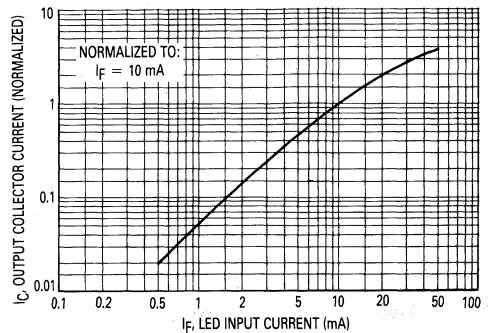

Figure 2. Output Current versus Input Current

4N38, 4N38A

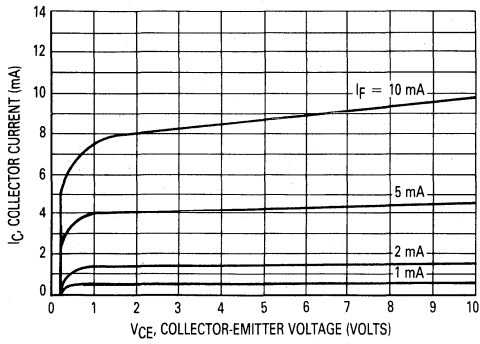

Figure 3. Collector Current versus Collector-Emitter Voltage

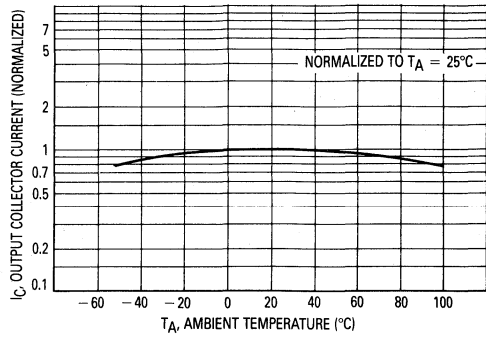

Figure 4. Output Current versus Ambient Temperature

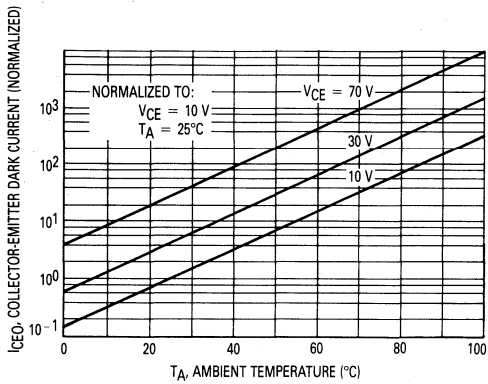

Figure 5. Dark Current versus Ambient Temperature

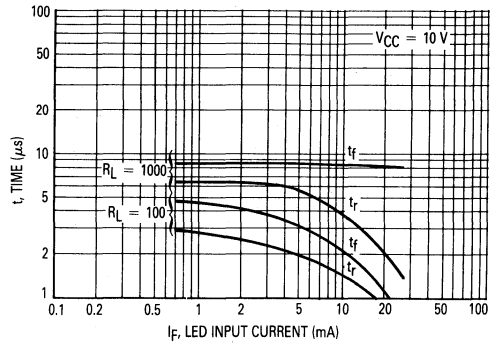

Figure 6. Rise and Fall Times

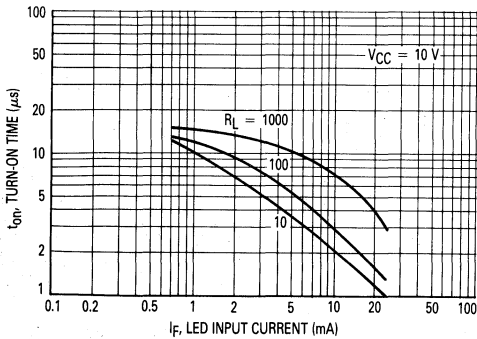

Figure 7. Turn-On Switching Times

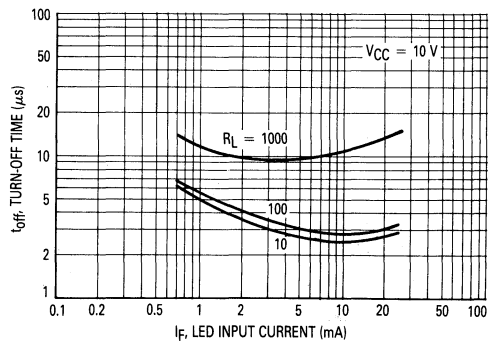

Figure 8. Turn-Off Switching Times

4N38, 4N38A

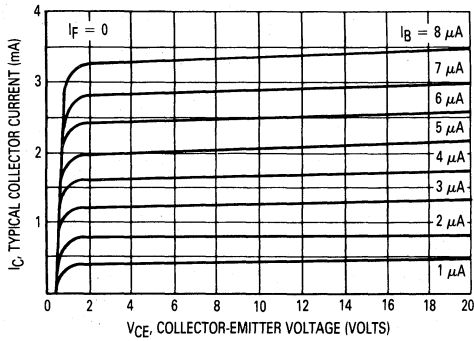

Figure 9. DC Current Gain (Detector Only)

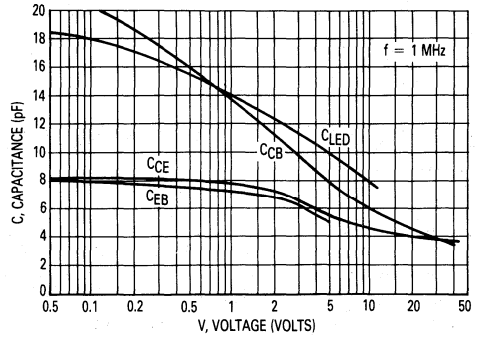

Figure 10. Capacitances versus Voltage

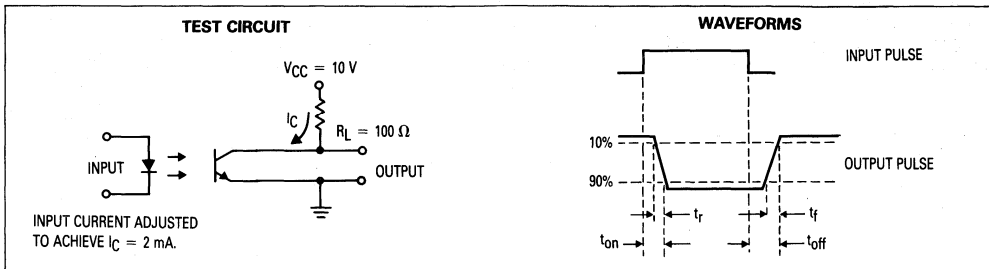
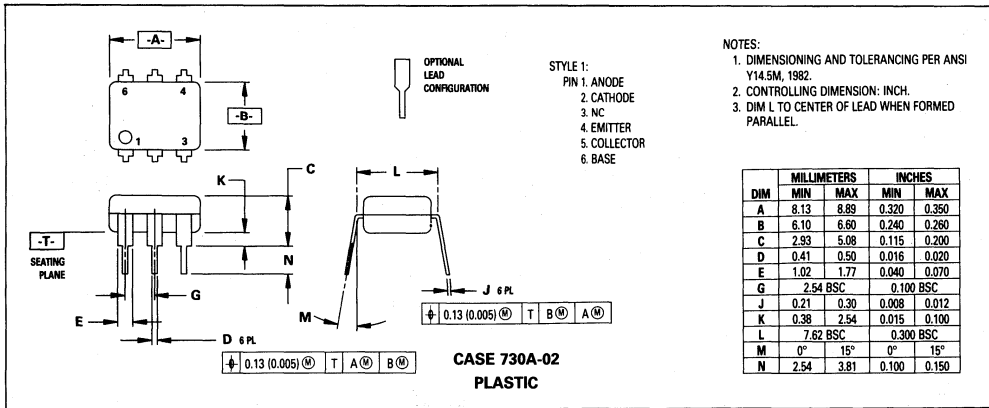



Figure 11. Switching Times

OUTLINE DIMENSIONS



6-Pin DIP Optoisolators SCR Output

These devices consist of a gallium-arsenide infrared emitting diode optically coupled to a photo sensitive silicon controlled rectifier (SCR). They are designed for applications requiring high electrical isolation between low voltage control circuitry and the ac line.

- High Blocking Voltage of 200 V for 120 Vac lines, or 400 V for 240 Vac Lines
- Very High Isolation Voltage: $V_{ISO} = 7500$ Vac Min
- Standard 6-Pin DIP
- UL Recognized, File Number E54915 
- Meets or Exceeds All JEDEC Registered Values
- VDE approved per standard 0883/6.80 (Certificate number 41853), with additional approval to DIN IEC380/VDE0806, IEC435/VDE0805, IEC65/VDE0860, VDE110b, covering all other standards with equal or less stringent requirements, including IEC204/
- Various lead form options available. Consult "Optoisolator Lead Form Options" data sheet for details.

MAXIMUM RATINGS* ($T_A = 25^\circ\text{C}$ unless otherwise noted)

| Rating | Symbol | Value | Unit |
|---|---------------------------|----------|-------------|
| INPUT LED | | | |
| Reverse Voltage | V_R | 6 | Volts |
| Forward Current — Continuous — Peak (PW = 100 μs , 1% duty cycle) | I_F $I_F(\text{pk})$ | 60 1 | mA A |
| Power Dissipation Derate above 50°C | P_D | 100 2 | mW mW/°C |

OUTPUT DRIVER

| | | | | |
|---|--------------|-------------------|------------|-------------|
| Peak Forward Blocking Voltage (-55° to +100°C) | 4N39 4N40 | V_{DM} | 200 400 | Volts |
| Forward RMS Current (Full Cycle, 50 to 60 Hz) | | $I_T(\text{RMS})$ | 300 | mA |
| Peak Nonrepetitive Surge Current (PW = 100 μs) | | I_{TSM} | 10 | A |
| Peak Reverse Gate Voltage | | V_{GR} | 6 | Volts |
| Peak Gate Input Current | | $I_G(\text{pk})$ | 100 | mA |
| Power Dissipation Derate above 25°C | | P_D | 400 8 | mW mW/°C |

TOTAL DEVICE

| | | | |
|--|-----------|-------------|-------------|
| Isolation Surge Voltage (1) (Peak ac Voltage, 60 Hz, 5 Second Duration) | V_{ISO} | 7500 | Vac |
| Total Device Power Dissipation Derate above 50°C | P_D | 450 9 | mW mW/°C |
| Junction Temperature Range | T_J | -40 to +100 | °C |
| Ambient Operating Temperature Range | T_A | -55 to +100 | °C |
| Storage Temperature Range | T_{stg} | -55 to +150 | °C |
| Soldering Temperature (10 s) | — | 260 | °C |

(1) Isolation surge voltage, V_{ISO} , is an internal device dielectric breakdown rating.
 * Indicates JEDEC registered values.

4N39
4N40

6-PIN DIP
OPTOISOLATORS
SCR OUTPUT
200 and 400 VOLTS

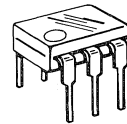

CASE 730A-02
PLASTIC

SCHEMATIC

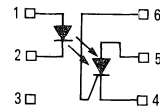

1. ANODE
2. CATHODE
3. N.C.
4. SCR CATHODE
5. SCR ANODE
6. SCR GATE

4N39, 4N40

ELECTRICAL CHARACTERISTICS ($T_A = 25^\circ\text{C}$ unless otherwise noted)

| Characteristic | Symbol | Min | Typ | Max | Unit |
|----------------|--------|-----|-----|-----|------|
|----------------|--------|-----|-----|-----|------|

INPUT LED

| | | | | | |
|---|-------|---|------|-----|---------------|
| Reverse Leakage Current ($V_R = 3\text{ V}$) | I_R | — | 0.05 | 10 | μA |
| Forward Voltage ($I_F = 10\text{ mA}$) | V_F | — | 1.2 | 1.5 | Volts |
| Capacitance ($V = 0\text{ V}$, $f = 1\text{ MHz}$) | C_J | — | 50 | — | pF |

OUTPUT DETECTOR

| | | | | | | |
|--|--------------|----------|------------|-----------|-----------|---------------|
| Peak Off-State Voltage ($R_{GK} = 10\text{ k}\Omega$, $T_A = 100^\circ\text{C}$) | 4N39 4N40 | V_{DM} | 200 400 | — — | — — | Volts |
| Peak Reverse Voltage ($T_A = 100^\circ\text{C}$) | 4N39 4N40 | V_{RM} | 200 400 | — — | — — | Volts |
| On-State Voltage ($I_{TM} = 0.3\text{ A}$) | | V_{TM} | — | 1.1 | 1.3 | Volts |
| Off-State Current ($V_{DM} = \text{Rated Voltage}$, $R_{GK} = 10\text{ k}\Omega$, $I_F = 0$, $T_A = 100^\circ\text{C}$) | 4N39 4N40 | I_{DM} | — — | — — | 50 150 | μA |
| Reverse Current ($V_{RM} = \text{Rated Voltage}$, $I_F = 0$, $T_A = 100^\circ\text{C}$) | 4N39 4N40 | I_{RM} | — — | — — | 50 150 | μA |
| Holding Current ($V_{FX} = 50\text{ V}$, $R_{GK} = 27\text{ k}\Omega$) | | I_H | — | — | 200 | μA |
| Capacitance ($V = 0\text{ V}$, $f = 1\text{ MHz}$) Anode — Gate Gate — Cathode | | C_J | — — | 20 350 | — — | pF |

COUPLED

| | | | | | |
|--|-----------|--------|---------|----------|----------------------|
| LED Current Required to Trigger ($V_{AK} = 50\text{ V}$, $R_{GK} = 10\text{ k}\Omega$) ($V_{AK} = 100\text{ V}$, $R_{GK} = 27\text{ k}\Omega$) | I_{FT} | — — | 15 8 | 30 14 | mA |
| Isolation Resistance Input to Output ($V_{IO} = 500\text{ Vdc}$) | R_{ISO} | 100 | — | — | $\text{G}\Omega$ |
| Capacitance Input to Output ($V_{IO} = 0$, $f = 1\text{ MHz}$) | C_{ISO} | — | 2 | — | pF |
| Turn-On Time ($V_{AK} = 50\text{ V}$, $I_F = 30\text{ mA}$, $R_{GK} = 10\text{ k}\Omega$, $R_L = 200\ \Omega$) | t_{on} | — | — | 50 | μs |
| Coupled dv/dt, Input to Output (See Figure 8) | dv/dt | — | 500 | — | Volts/ μs |
| Isolation Surge Voltage (1) (Peak ac Voltage, 60 Hz, 5 Second Duration) | V_{ISO} | 7500 | — | — | Vac(pk) |

(1) Isolation surge voltage, V_{ISO} , is an internal device dielectric breakdown rating.
* Indicates JEDEC registered values.

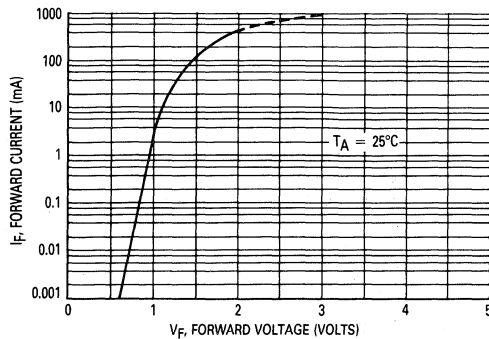

Figure 1. Forward Current versus LED Forward Voltage

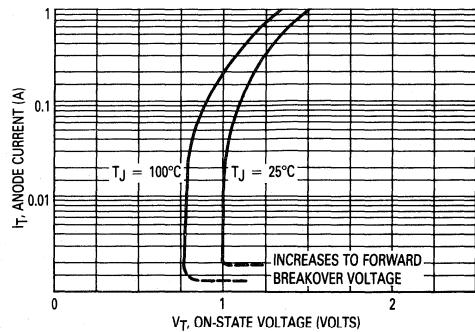

Figure 2. On-State Characteristics

4N39, 4N40

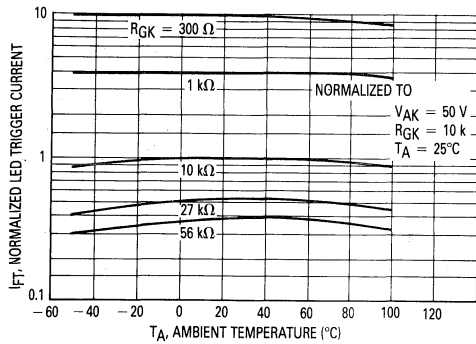

Figure 3. LED Trigger Current versus Temperature

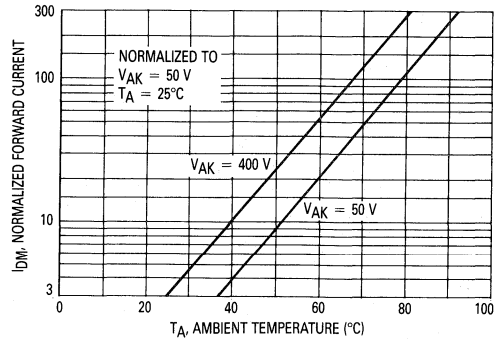
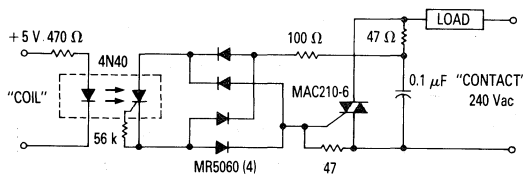

Figure 4. Forward Leakage Current versus Temperature

TYPICAL APPLICATIONS



Use of the 4N40 for high sensitivity, 7500 V isolation capability, provides this highly reliable solid state relay design. This design is compatible with 74, 74S and 74H series T²L logic systems inputs and 240 Vac loads up to 10 A.

Figure 5. 10 A, T²L Compatible, Solid State Relay

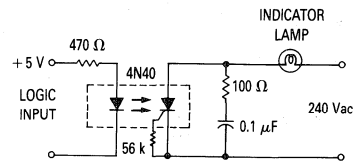

The high surge capability and non-reactive input characteristics of the 4N40 allow it to directly couple, without buffers, T²L and DTL logic to indicator and alarm devices, without danger of introducing noise and logic glitches.

Figure 6. 25 W Logic Indicator Lamp Driver

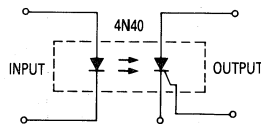

Use of the high voltage PNP portion of the 4N40, provides a 400 V transistor capable of conducting positive and negative signals with current transfer ratios of over 1%. This function is useful in remote instrumentation, high voltage power supplies and test equipment. Care should be taken not to exceed the device 400 mW power dissipation rating when used at high voltages.

Figure 7. 400 V Symmetrical Transistor Coupler

4N39, 4N40

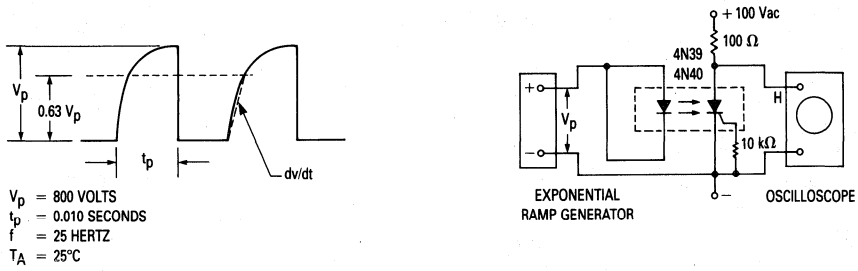
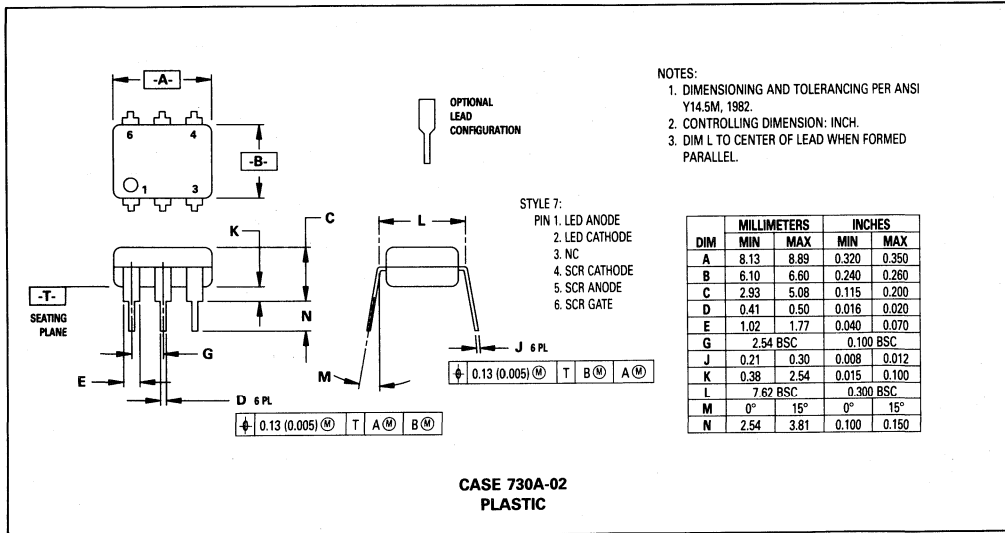



Figure 8. Coupled dv/dt — Test Circuit

OUTLINE DIMENSIONS



6-Pin DIP Optoisolators Transistor Output

These devices consist of a gallium arsenide infrared emitting diode optically coupled to a monolithic silicon phototransistor detector.

- Convenient Plastic Dual-in-Line Package
- Guaranteed 70 Volt $V_{(BR)CEO}$ Minimum
- High Input-Output Isolation Guaranteed — 7500 Volts Peak
- UL Recognized. File Number E54915 
- VDE approved per standard 0883/6.80 (Certificate number 41853), with additional approval to DIN IEC380/VDE0806, IEC435/VDE0805, IEC65/VDE0860, VDE0110b, covering all other standards with equal or less stringent requirements, including  883
- Special lead form available (add suffix "T" to part number) which satisfies VDE0883/6.80 requirement for 8 mm minimum creepage distance between input and output solder pads.
- Various lead form options available. Consult "Optoisolator Lead Form Options" data sheet for details.

CNY17-1
CNY17-2
CNY17-3

6-PIN DIP
OPTOISOLATORS
TRANSISTOR OUTPUT



CASE 730A-02
PLASTIC

MAXIMUM RATINGS ($T_A = 25^\circ\text{C}$ unless otherwise noted)

| Rating | Symbol | Value | Unit |
|--------|--------|-------|------|
|--------|--------|-------|------|

INPUT LED

| | | | |
|---|------------------|------|----------------------------|
| Reverse Voltage | V_R | 6 | Volts |
| Forward Current — Continuous | I_F | 60 | mA |
| Forward Current — Pk ($PW = 1 \mu\text{s}$, 330 pps) | $I_F(\text{pk})$ | 1.5 | A |
| LED Power Dissipation @ $T_A = 25^\circ\text{C}$ with Negligible Power in Output Detector Derate above 25°C | P_D | 120 | mW |
| | | 1.41 | $\text{mW}/^\circ\text{C}$ |

OUTPUT TRANSISTOR

| | | | |
|--|-----------|------|----------------------------|
| Collector-Emitter Voltage | V_{CEO} | 70 | Volts |
| Emitter-Base Voltage | V_{EBO} | 7 | Volts |
| Collector-Base Voltage | V_{CBO} | 70 | Volts |
| Collector Current — Continuous | I_C | 100 | mA |
| Detector Power Dissipation @ $T_A = 25^\circ\text{C}$ with Negligible Power in Input LED Derate above 25°C | P_D | 150 | mW |
| | | 1.76 | $\text{mW}/^\circ\text{C}$ |

TOTAL DEVICE

| | | | |
|--|-----------|-------------|----------------------------------|
| Isolation Surge Voltage (1) (Peak ac Voltage, 60 Hz, 1 sec Duration) | V_{ISO} | 7500 | Vac |
| Total Device Power Dissipation @ $T_A = 25^\circ\text{C}$ Derate above 25°C | P_D | 250 2.94 | mW $\text{mW}/^\circ\text{C}$ |
| Ambient Operating Temperature Range | T_A | -55 to +100 | $^\circ\text{C}$ |
| Storage Temperature Range | T_{stg} | -55 to +150 | $^\circ\text{C}$ |
| Soldering Temperature (10 sec, 1/16" from case) | T_{sol} | 260 | $^\circ\text{C}$ |

(1) Isolation surge voltage is an internal device dielectric breakdown rating. For this test, Pins 1 and 2 are common, and Pins 4, 5 and 6 are common.

SCHEMATIC

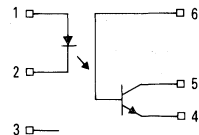

1. LED ANODE
2. LED CATHODE
3. N.C.
4. EMITTER
5. COLLECTOR
6. BASE

CNY17-1, CNY17-2, CNY17-3

ELECTRICAL CHARACTERISTICS ($T_A = 25^\circ\text{C}$ unless otherwise noted)

| Characteristic | Symbol | Min | Typ | Max | Unit | |
|--|--|---------------|----------------|---------------------|-----------------|------------------|
| INPUT LED | | | | | | |
| Forward Voltage ($I_F = 60\text{ mA}$) | $T_A = 25^\circ\text{C}$ $T_A = -55^\circ\text{C}$ $T_A = 100^\circ\text{C}$ | V_F | — — — | 1.35 1.5 1.25 | 1.65 — — | Volts |
| Reverse Leakage Current ($V_R = 6\text{ V}$) | | I_R | — | — | 10 | μA |
| Capacitance ($V = 0, f = 1\text{ MHz}$) | | C_J | — | 18 | — | pF |
| OUTPUT TRANSISTOR | | | | | | |
| Collector-Emitter Dark Current ($V_{CE} = 10\text{ V}, T_A = 25^\circ\text{C}$) | CNY17-1,2 CNY17-3 | I_{CEO} | — — | 5 5 | 50 100 | nA |
| ($V_{CE} = 10\text{ V}, T_A = 100^\circ\text{C}$) | All devices | I_{CEO} | — | 1.6 | — | μA |
| Collector-Base Dark Current ($V_{CB} = 10\text{ V}$) | | I_{CBO} | — | 0.5 | — | nA |
| Collector-Emitter Breakdown Voltage ($I_C = 1\text{ mA}$) | | $V_{(BR)CEO}$ | 70 | 120 | — | Volts |
| Collector-Base Breakdown Voltage ($I_C = 100\text{ }\mu\text{A}$) | | $V_{(BR)CBO}$ | 70 | 120 | — | Volts |
| Emitter-Base Breakdown Voltage ($I_E = 100\text{ }\mu\text{A}$) | | $V_{(BR)EBO}$ | 7 | 7.8 | — | Volts |
| DC Current Gain ($I_C = 2\text{ mA}, V_{CE} = 5\text{ V}$) | | h_{FE} | — | 400 | — | — |
| Collector-Emitter Capacitance ($f = 1\text{ MHz}, V_{CE} = 0$) | | C_{CE} | — | 8 | — | pF |
| Collector-Base Capacitance ($f = 1\text{ MHz}, V_{CB} = 0$) | | C_{CB} | — | 21 | — | pF |
| Emitter-Base Capacitance ($f = 1\text{ MHz}, V_{EB} = 0$) | | C_{EB} | — | 8 | — | pF |
| COUPLED | | | | | | |
| Output Collector Current ($I_F = 10\text{ mA}, V_{CE} = 5\text{ V}$) | CNY17-1 CNY17-2 CNY17-3 | I_C | 4 6.3 10 | 6 10 15 | 8 12.5 20 | mA |
| Collector-Emitter Saturation Voltage ($I_C = 2.5\text{ mA}, I_F = 10\text{ mA}$) | | $V_{CE(sat)}$ | — | 0.18 | 0.4 | Volts |
| Delay Time ($I_F = 10\text{ mA}, V_{CC} = 5\text{ V}, R_L = 75\text{ }\Omega$, Figure 11) | | t_d | — | 1.6 | 5.6 | μs |
| Rise Time ($I_F = 10\text{ mA}, V_{CC} = 5\text{ V}, R_L = 75\text{ }\Omega$, Figure 11) | | t_r | — | 1.6 | 4 | μs |
| Storage Time ($I_F = 10\text{ mA}, V_{CC} = 5\text{ V}, R_L = 75\text{ }\Omega$, Figure 11) | | t_s | — | 0.7 | 4.1 | μs |
| Fall Time ($I_F = 10\text{ mA}, V_{CC} = 5\text{ V}, R_L = 75\text{ }\Omega$, Figure 11) | | t_f | — | 2.3 | 3.5 | μs |
| Delay Time ($I_F = 20\text{ mA}, V_{CC} = 5\text{ V}, R_L = 1\text{ k}\Omega$, Figure 11) | CNY17-1 | t_d | — | 1.2 | 5.5 | μs |
| ($I_F = 10\text{ mA}, V_{CC} = 5\text{ V}, R_L = 1\text{ k}\Omega$, Figure 11) | CNY17-2,3 | | — | 1.8 | 8 | |
| Rise Time ($I_F = 20\text{ mA}, V_{CC} = 5\text{ V}, R_L = 1\text{ k}\Omega$, Figure 11) | CNY17-1 | t_r | — | 3.3 | 4 | μs |
| ($I_F = 10\text{ mA}, V_{CC} = 5\text{ V}, R_L = 1\text{ k}\Omega$, Figure 11) | CNY17-2,3 | | — | 5 | 6 | |
| Storage Time ($I_F = 20\text{ mA}, V_{CC} = 5\text{ V}, R_L = 1\text{ k}\Omega$, Figure 11) | CNY17-1 | t_s | — | 4.4 | 34 | μs |
| ($I_F = 10\text{ mA}, V_{CC} = 5\text{ V}, R_L = 1\text{ k}\Omega$, Figure 11) | CNY17-2,3 | | — | 2 | 39 | |
| Fall Time ($I_F = 20\text{ mA}, V_{CC} = 5\text{ V}, R_L = 1\text{ k}\Omega$, Figure 11) | CNY17-1 | t_f | — | 9.7 | 20 | μs |
| ($I_F = 10\text{ mA}, V_{CC} = 5\text{ V}, R_L = 1\text{ k}\Omega$, Figure 11) | CNY17-2,3 | | — | 9.4 | 24 | |
| Isolation Voltage ($f = 60\text{ Hz}, t = 1\text{ sec}$) | | V_{ISO} | 7500 | — | — | Vac(pk) |
| Isolation Resistance ($V = 500\text{ V}$) | | R_{ISO} | 10^{11} | — | — | Ω |
| Isolation Capacitance ($V = 0, f = 1\text{ MHz}$) | | C_{ISO} | — | 0.2 | 0.5 | pF |

CNY17-1, CNY17-2, CNY17-3

TYPICAL CHARACTERISTICS

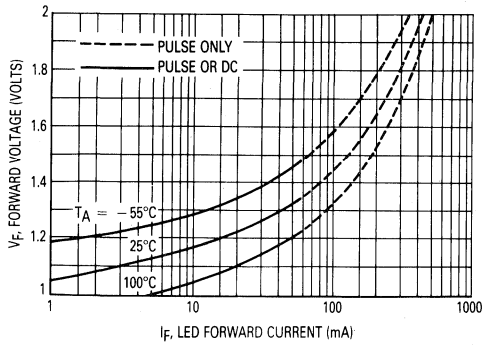

Figure 1. LED Forward Voltage versus Forward Current

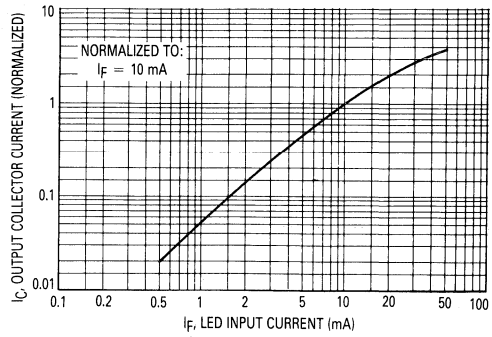

Figure 2. Output Current versus Input Current

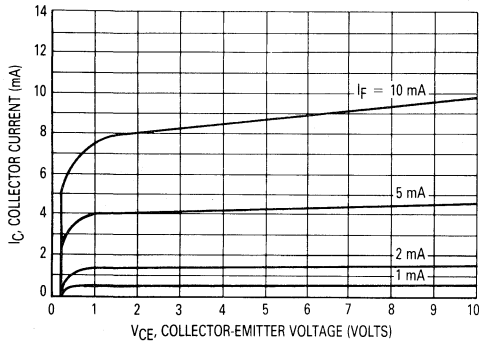

Figure 3. Collector Current versus Collector-Emitter Voltage

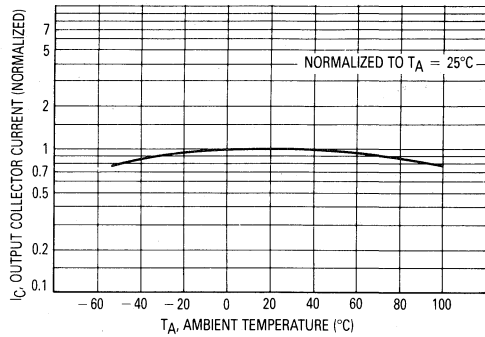

Figure 4. Output Current versus Ambient Temperature

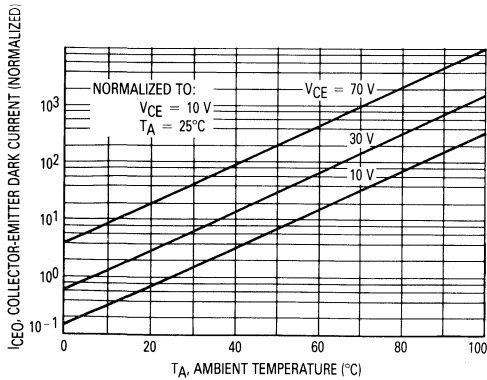

Figure 5. Dark Current versus Ambient Temperature

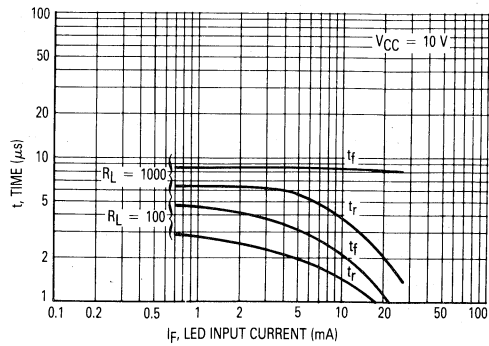

Figure 6. Rise and Fall Times

CNY17-1, CNY17-2, CNY17-3

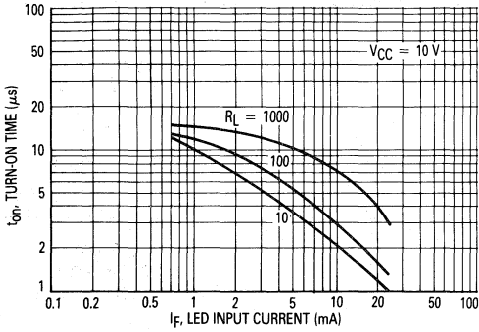

Figure 7. Turn-On Switching Times

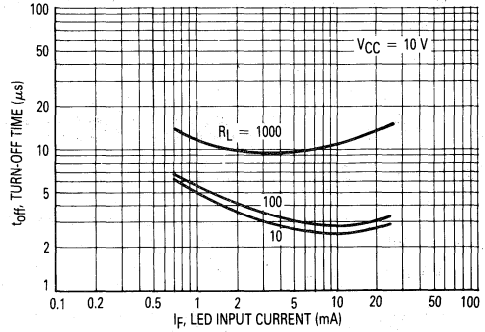

Figure 8. Turn-Off Switching Times

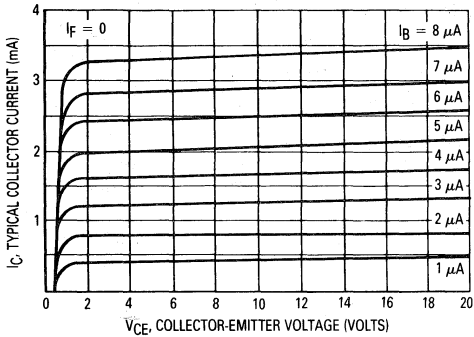

Figure 9. DC Current Gain (Detector Only)

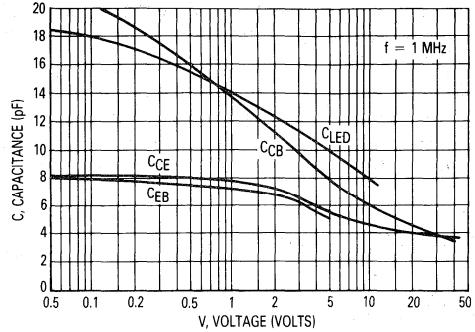

Figure 10. Capacitances versus Voltage

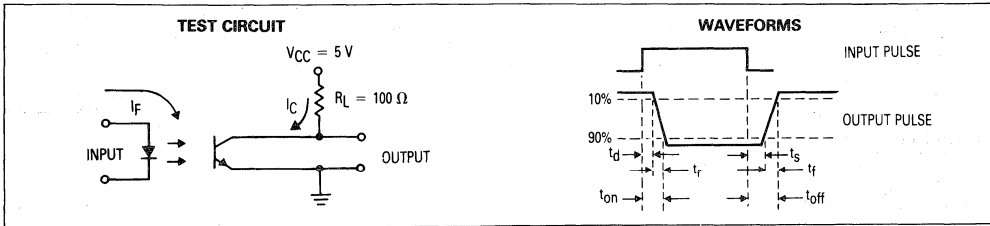
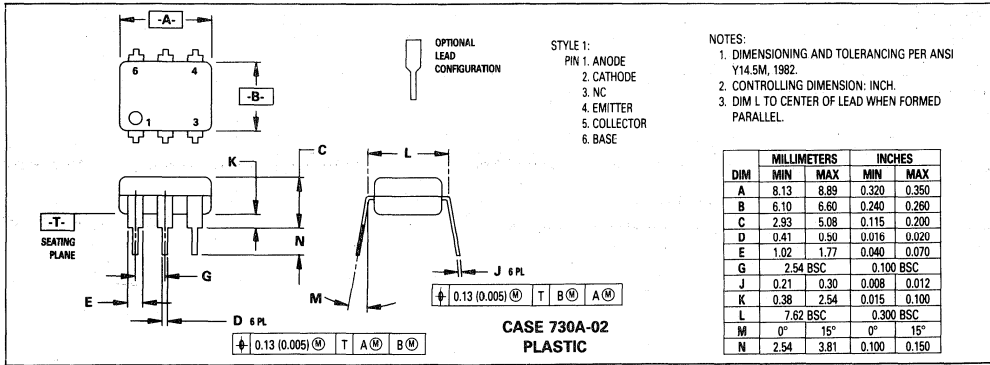



Figure 11. Switching Times

OUTLINE DIMENSIONS



6-Pin DIP Optoisolators Transistor Output

These devices consist of a gallium arsenide infrared emitting diode optically coupled to a monolithic silicon phototransistor detector.

- Convenient Plastic Dual-in-Line Package
- Economical
- High Input-Output Isolation Guaranteed — 7500 Volts Peak
- UL Recognized. File Number E54915 
- VDE approved per standard 0883/6.80 (Certificate number 41853), with additional approval to DIN IEC380/VDE0806, IEC435/VDE0805, IEC65/VDE0860, VDE110b, covering all other standards with equal or less stringent requirements, including IEC204/VDE0113, VDE0160, VDE0832, VDE0833, etc. 
- Special lead form available (add suffix "T" to part number) which satisfies VDE0883/6.80 requirement for 8 mm minimum creepage distance between input and output solder pads.
- Various lead form options available. Consult "Optoisolator Lead Form Options" data sheet for details.

MAXIMUM RATINGS ($T_A = 25^\circ\text{C}$ unless otherwise noted)

| Rating | Symbol | Value | Unit |
|--------|--------|-------|------|
|--------|--------|-------|------|

INPUT LED

| | | | |
|---|-------|------|----------------------|
| Reverse Voltage | V_R | 3 | Volts |
| Forward Current — Continuous | I_F | 60 | mA |
| LED Power Dissipation @ $T_A = 25^\circ\text{C}$ with Negligible Power in Output Detector Derate above 25°C | P_D | 120 | mW |
| | | 1.41 | mW/ $^\circ\text{C}$ |

OUTPUT TRANSISTOR

| | | | |
|--|-----------|------|----------------------|
| Collector-Emitter Voltage | V_{CEO} | 30 | Volts |
| Emitter-Collector Voltage | V_{ECO} | 7 | Volts |
| Collector-Base Voltage | V_{CBO} | 70 | Volts |
| Collector Current — Continuous | I_C | 150 | mA |
| Detector Power Dissipation @ $T_A = 25^\circ\text{C}$ with Negligible Power in Input LED Derate above 25°C | P_D | 150 | mW |
| | | 1.76 | mW/ $^\circ\text{C}$ |

TOTAL DEVICE

| | | | |
|--|-----------|-------------|----------------------------|
| Isolation Surge Voltage (1) (Peak ac Voltage, 60 Hz, 1 sec Duration) | V_{ISO} | 7500 | Vac |
| Total Device Power Dissipation @ $T_A = 25^\circ\text{C}$ Derate above 25°C | P_D | 250 2.94 | mW mW/ $^\circ\text{C}$ |
| Ambient Operating Temperature Range | T_A | -55 to +100 | $^\circ\text{C}$ |
| Storage Temperature Range | T_{stg} | -55 to +150 | $^\circ\text{C}$ |
| Soldering Temperature (10 sec, 1/16" from case) | T_{sol} | 260 | $^\circ\text{C}$ |

(1) Isolation surge voltage is an internal device dielectric breakdown rating. For this test, Pins 1 and 2 are common, and Pins 4, 5 and 6 are common.

**H11A1
 thru
 H11A5**

**6-PIN DIP
 OPTOISOLATORS
 TRANSISTOR OUTPUT**

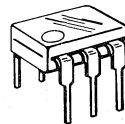

**CASE 730A-02
 PLASTIC**

SCHEMATIC

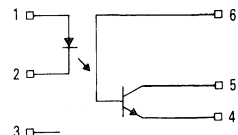

1. LED ANODE
2. LED CATHODE
3. N.C.
4. EMITTER
5. COLLECTOR
6. BASE

H11A1 thru H11A5

ELECTRICAL CHARACTERISTICS (T_A = 25°C unless otherwise noted)

| Characteristic | Symbol | Min | Typ | Max | Unit |
|---|----------------|-----|---------------------|-----|-------|
| Forward Voltage (I _F = 10 mA, T _A = 25°C) T _A = -55°C T _A = 100°C | V _F | — | 1.15 1.3 1.05 | 1.5 | Volts |
| Reverse Leakage Current (V _R = 3 V) | I _R | — | 0.01 | 10 | μA |
| Capacitance (V = 0 V, f = 1 MHz) | C _J | — | 18 | — | pF |

OUTPUT TRANSISTOR

| | | | | | |
|--|----------------------|----|------------|----|----------|
| Collector-Emitter Dark Current (V _{CE} = 10 V) T _A = 25°C T _A = 100°C | I _{CEO} | — | 1 1 | 50 | nA μA |
| Collector-Base Dark Current (V _{CB} = 10 V) T _A = 25°C T _A = 100°C | I _{CBO} | — | 0.2 100 | 20 | nA |
| Collector-Emitter Breakdown Voltage (I _C = 10 mA) | V _{(BR)CEO} | 30 | 45 | — | Volts |
| Collector-Base Breakdown Voltage (I _C = 100 μA) | V _{(BR)CBO} | 70 | 100 | — | Volts |
| Emitter-Collector Breakdown Voltage (I _E = 100 μA) | V _{(BR)ECO} | 7 | 7.8 | — | Volts |
| DC Current Gain (I _C = 5 mA, V _{CE} = 5 V) | h _{FE} | — | 500 | — | — |
| Collector-Emitter Capacitance (f = 1 MHz, V _{CE} = 0 V) | C _{CE} | — | 7 | — | pF |
| Collector-Base Capacitance (f = 1 MHz, V _{CB} = 0 V) | C _{CB} | — | 19 | — | pF |
| Emitter-Base Capacitance (f = 1 MHz, V _{EB} = 0 V) | C _{EB} | — | 9 | — | pF |

COUPLED

| | | | | | |
|---|----------------------|------------------|-------------------|-----|---------|
| Output Collector Current (I _F = 10 mA, V _{CE} = 10 V) H11A1 H11A2,3 H11A4 H11A5 | I _C | 5 2 1 3 | 12 7 5 9 | — | mA |
| Collector-Emitter Saturation Voltage (I _C = 0.5 mA, I _F = 10 mA) | V _{CE(sat)} | — | 0.1 | 0.4 | Volts |
| Turn-On Time (I _F = 10 mA, V _{CC} = 10 V, R _L = 100 Ω, Figure 11) | t _{on} | — | 2.8 | — | μs |
| Turn-Off Time (I _F = 10 mA, V _{CC} = 10 V, R _L = 100 Ω, Figure 11) | t _{off} | — | 4.5 | — | μs |
| Rise Time (I _F = 10 mA, V _{CC} = 10 V, R _L = 100 Ω, Figure 11) | t _r | — | 1.2 | — | μs |
| Fall Time (I _F = 10 mA, V _{CC} = 10 V, R _L = 100 Ω, Figure 11) | t _f | — | 1.3 | — | μs |
| Isolation Voltage (f = 60 Hz, t = 1 sec) | V _{ISO} | 7500 | — | — | Vac(pk) |
| Isolation Resistance (V = 500 V) | R _{ISO} | 10 ¹¹ | — | — | Ω |
| Isolation Capacitance (V = 0 V, f = 1 MHz) | C _{ISO} | — | 0.2 | — | pF |

6

TYPICAL CHARACTERISTICS

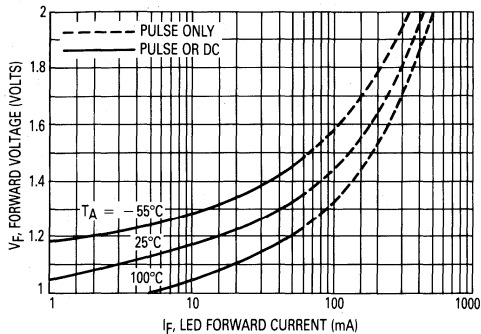

Figure 1. LED Forward Voltage versus Forward Current

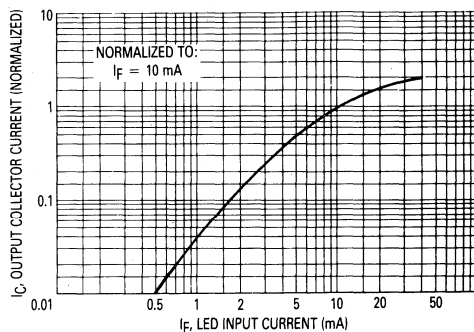

Figure 2. Output Current versus Input Current

H11A1 thru H11A5

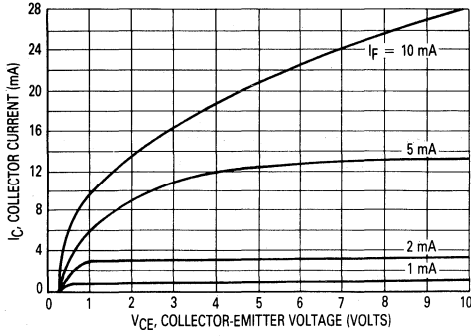

Figure 3. Collector Current versus Collector-Emitter Voltage

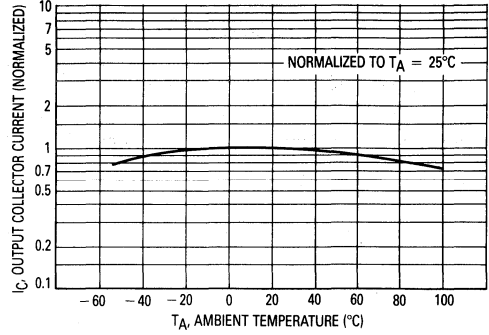

Figure 4. Output Current versus Ambient Temperature

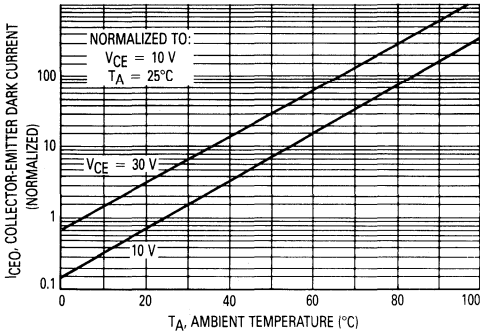

Figure 5. Dark Current versus Ambient Temperature

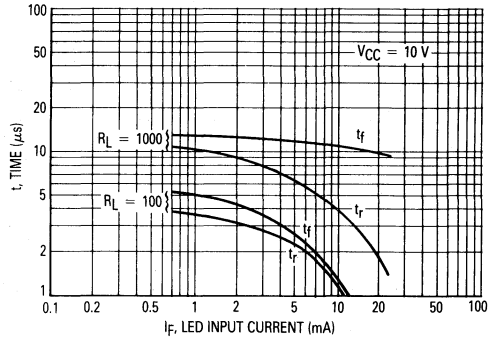

Figure 6. Rise and Fall Times

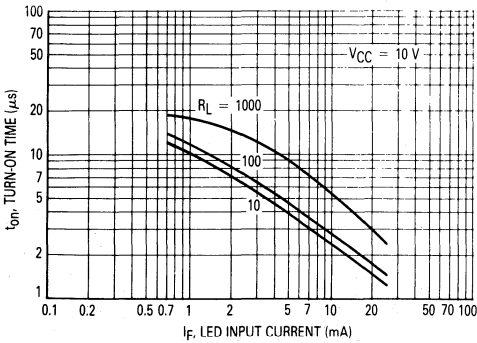

Figure 7. Turn-On Switching Times

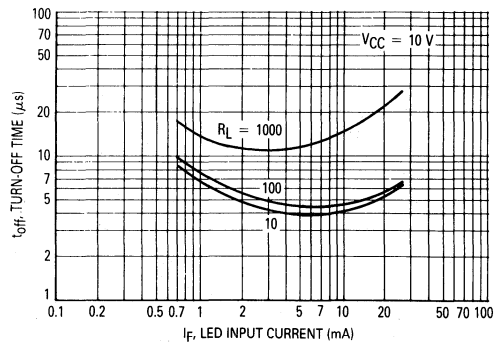

Figure 8. Turn-Off Switching Times



H11A1 thru H11A5

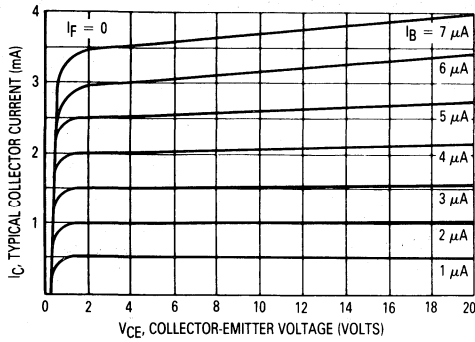

Figure 9. DC Current Gain (Detector Only)

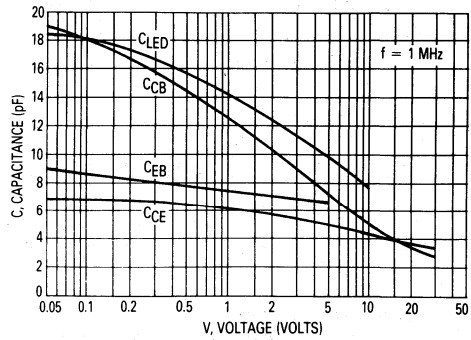

Figure 10. Capacitances versus Voltage

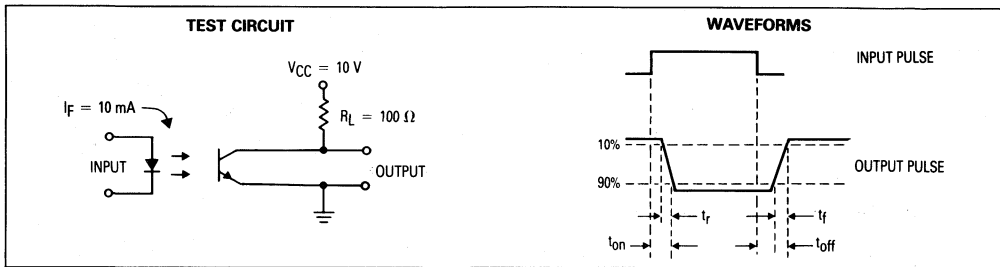
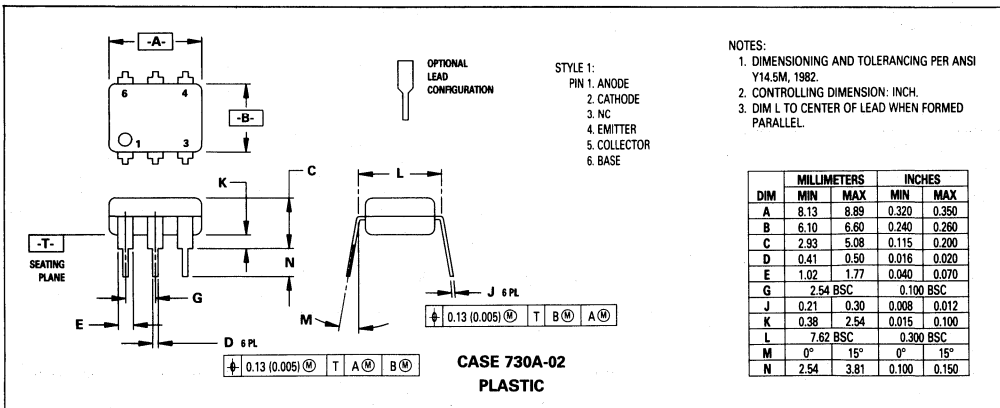



Figure 11. Switching Times

OUTLINE DIMENSIONS



6-Pin DIP Optoisolators AC Input/Transistor Output

These devices consist of two gallium arsenide infrared emitting diodes connected in inverse-parallel, optically coupled to a monolithic silicon phototransistor detector. They are designed for applications requiring the detection or monitoring of ac signals.

- Convenient Plastic Dual-in-Line Package
- Built-In Protection for Reverse Polarity
- High Input-Output Isolation Guaranteed — 7500 Volts Peak
- UL Recognized. File Number E54915 
- Various lead form options available. Consult "Optoisolator Lead Form Options" data sheet for details.

**H11AA1
thru
H11AA4**

**6-PIN DIP
OPTOISOLATORS
AC INPUT
TRANSISTOR OUTPUT**

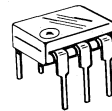

**CASE 730A-02
PLASTIC**

MAXIMUM RATINGS ($T_A = 25^\circ\text{C}$ unless otherwise noted)

| Rating | Symbol | Value | Unit |
|--------|--------|-------|------|
|--------|--------|-------|------|

INPUT LED

| | | | |
|---|-------|------|----------------------|
| Forward Current — Continuous (RMS) | I_F | 60 | mA |
| LED Power Dissipation @ $T_A = 25^\circ\text{C}$ with Negligible Power in Output Detector Derate above 25°C | P_D | 120 | mW |
| | | 1.41 | mW/ $^\circ\text{C}$ |

OUTPUT TRANSISTOR

| | | | |
|---|-----------|------|----------------------|
| Collector-Emitter Voltage | V_{CEO} | 30 | Volts |
| Emitter-Base Voltage | V_{EBO} | 5 | Volts |
| Collector-Base Voltage | V_{CBO} | 70 | Volts |
| Collector Current — Continuous | I_C | 150 | mA |
| Detector Power Dissipation @ $T_A = 25^\circ\text{C}$ with Negligible Power in Input LEDs Derate above 25°C | P_D | 150 | mW |
| | | 1.76 | mW/ $^\circ\text{C}$ |

TOTAL DEVICE

| | | | |
|--|-----------|-------------|----------------------------|
| Isolation Surge Voltage (1) (Peak ac Voltage, 60 Hz, 1 sec Duration) | V_{ISO} | 7500 | Vac |
| Total Device Power Dissipation @ $T_A = 25^\circ\text{C}$ Derate above 25°C | P_D | 250 2.94 | mW mW/ $^\circ\text{C}$ |
| Ambient Operating Temperature Range | T_A | -55 to +100 | $^\circ\text{C}$ |
| Storage Temperature Range | T_{stg} | -55 to +150 | $^\circ\text{C}$ |
| Soldering Temperature (10 sec, 1/16" from case) | T_{sol} | 260 | $^\circ\text{C}$ |

(1) Isolation surge voltage is an internal device dielectric breakdown rating. For this test, Pins 1 and 2 are common, and Pins 4, 5 and 6 are common.

SCHEMATIC

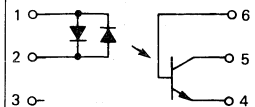

1. INPUT LED
2. INPUT LED
3. N.C.
4. EMITTER
5. COLLECTOR
6. BASE

H11AA1 thru H11AA4

ELECTRICAL CHARACTERISTICS (T_A = 25°C unless otherwise noted)

| Characteristic | Symbol | Min | Typ | Max | Unit |
|---|------------------------------------|-----|------|-----|-------|
| INPUT LEDS | | | | | |
| Forward Voltage (I _F = 10 mA, either direction) | H11AA1,3,4 | — | 1.15 | 1.5 | Volts |
| | H11AA2 | — | 1.15 | 1.8 | |
| | T _A = -55°C All devices | — | 1.3 | — | |
| | T _A = 100°C All devices | — | 1.05 | — | |
| Capacitance (V = 0 V, f = 1 MHz) | C _J | — | 18 | — | pF |

OUTPUT TRANSISTOR

| | | | | | | |
|--|------------------------------------|----------------------|----|-----|-----|-------|
| Collector-Emitter Dark Current (V _{CE} = 10 V) | H11AA1,3,4 | I _{CEO} | — | 1 | 100 | nA |
| | H11AA2 | | — | 1 | 200 | nA |
| | T _A = 100°C All devices | | — | 1 | — | μA |
| Collector-Base Dark Current (V _{CB} = 10 V) | | I _{CBO} | — | 0.2 | — | nA |
| Collector-Emitter Breakdown Voltage (I _C = 10 mA) | | V _{(BR)CEO} | 30 | 45 | — | Volts |
| Collector-Base Breakdown Voltage (I _C = 100 μA) | | V _{(BR)CBO} | 70 | 100 | — | Volts |
| Emitter-Collector Breakdown Voltage (I _E = 100 μA) | | V _{(BR)ECO} | 5 | 7.8 | — | Volts |
| DC Current Gain (I _C = 2 mA, V _{CE} = 5 V) | | h _{FE} | — | 500 | — | — |
| Collector-Emitter Capacitance (f = 1 MHz, V _{CE} = 0 V) | | C _{CE} | — | 7 | — | pF |
| Collector-Base Capacitance (f = 1 MHz, V _{CB} = 0 V) | | C _{CB} | — | 19 | — | pF |
| Emitter-Base Capacitance (f = 1 MHz, V _{EB} = 0 V) | | C _{EB} | — | 9 | — | pF |

COUPLED

| | | | | | | |
|--|------------|----------------------|------------------|-----|-----|---------|
| Output Collector Current (I _F = ±10 mA, V _{CE} = 10 V) | H11AA1 | I _C | 2 | 5 | — | mA |
| | H11AA2 | | 1 | 2 | — | |
| | H11AA3 | | 5 | 10 | — | |
| | H11AA4 | | 10 | 15 | — | |
| Output Collector Current Symmetry (Note 1) (I _C at I _F = +10 mA, V _{CE} = 10 V) (I _C at I _F = -10 mA, V _{CE} = 10 V) | H11AA1,3,4 | — | 0.33 | — | 3 | — |
| | | | | | | |
| Collector-Emitter Saturation Voltage (I _C = 0.5 mA, I _F = ±10 mA) | | V _{CE(sat)} | — | 0.1 | 0.4 | Volts |
| Isolation Voltage (f = 60 Hz, t = 1 sec) | | V _{ISO} | 7500 | — | — | Vac(pk) |
| Isolation Resistance (V = 500 V) | | R _{ISO} | 10 ¹¹ | — | — | Ω |
| Isolation Capacitance (V = 0 V, f = 1 MHz) | | C _{ISO} | — | 0.2 | — | pF |

Note 1. This specification guarantees that the higher of the two I_C readings will be no more than 3 times the lower at I_F = 10 mA.

6

TYPICAL CHARACTERISTICS

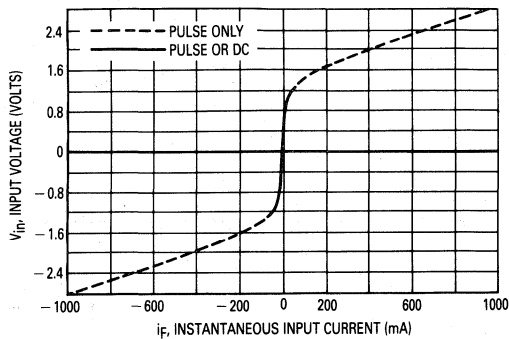

Figure 1. Input Voltage versus Input Current

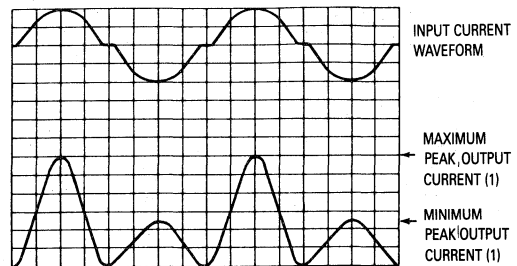

Figure 2. Output Characteristics

H11AA1 thru H11AA4

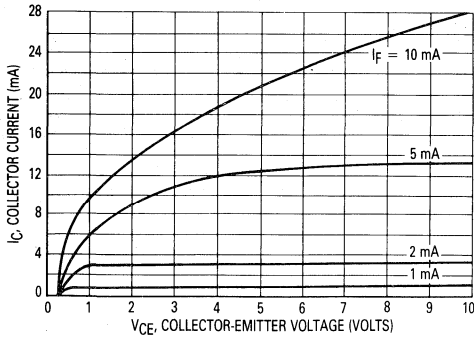

Figure 3. Collector Current versus Collector-Emitter Voltage

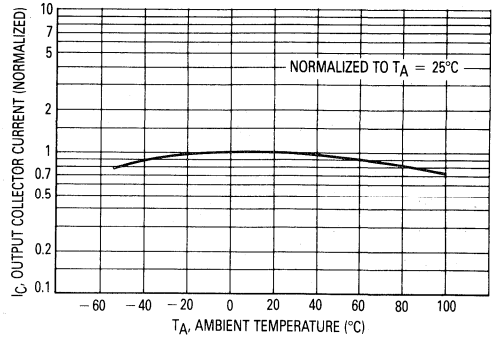

Figure 4. Output Current versus Ambient Temperature

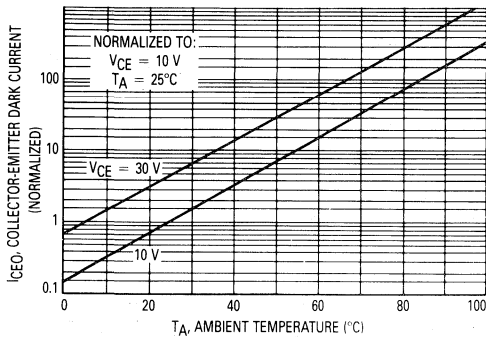

Figure 5. Dark Current versus Ambient Temperature

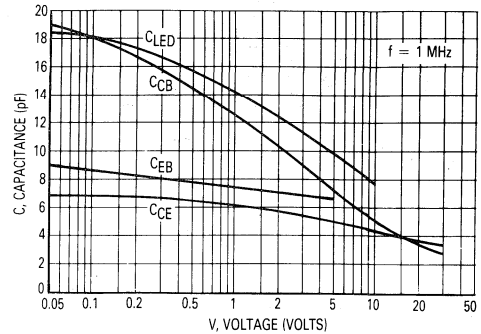
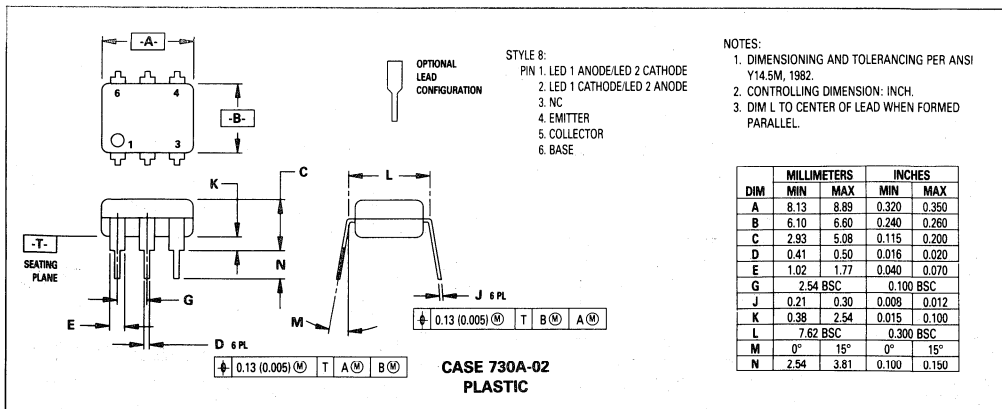



Figure 6. Capacitances versus Voltage

OUTLINE DIMENSIONS



6-Pin DIP Optoisolators Transistor Output

Each device consists of a gallium arsenide infrared emitting diode optically coupled to a monolithic silicon phototransistor detector.

- High Efficiency, Low Degradation Liquid-Phase Epitaxial Emitter
- High Input-Output Isolation Guaranteed — 7500 Volts Peak
- UL Recognized. File Number E54915 
- VDE approved per standard 0883/6.80 (Certificate number 41853), with additional approval to DIN IEC380/VDE0806, IEC435/VDE0805, IEC65/VDE0860, VDE0110b, covering all other standards with equal or less stringent requirements, including IEC204/VDE0113, VDE0160, VDE0832, VDE0833, etc.  883
- Part numbers with suffix 'A' permit circuit board mounting on 0.400" centers, which satisfies VDE requirement for 8 mm minimum creepage distance between input and output solder pads.
- Internal Conductive Part Separation 0.5 mm Minimum which now satisfies all above mentioned VDE and DIN IEC standards. For details consult "Application of the Motorola VDE Approved Optocouplers," AN978.
- Other lead form options are available. Consult "Optoisolator Lead Form Options" data sheet for details.

MAXIMUM RATINGS (T_A = 25°C unless otherwise noted)

| Rating | Symbol | Value | Unit |
|---|----------------|-------|-------|
| INPUT LED | | | |
| Reverse Voltage | V _R | 6 | Volts |
| Forward Current — Continuous | I _F | 60 | mA |
| LED Power Dissipation @ T _A = 25°C with Negligible Power in Output Detector | P _D | 120 | mW |
| Derate above 25°C | | 1.41 | mW/°C |

OUTPUT TRANSISTOR

| | | | |
|--|------------------|------|-------|
| Collector-Emitter Voltage | V _{CEO} | 70 | Volts |
| Emitter-Base Voltage | V _{EB0} | 7 | Volts |
| Collector-Base Voltage | V _{CB0} | 70 | Volts |
| Collector Current — Continuous | I _C | 150 | mA |
| Detector Power Dissipation @ T _A = 25°C with Negligible Power in Input LED | P _D | 150 | mW |
| Derate above 25°C | | 1.76 | mW/°C |

TOTAL DEVICE

| | | | |
|---|------------------|-------------|-------------|
| Isolation Surge Voltage (1) (Peak ac Voltage, 60 Hz, 1 sec Duration) | V _{ISO} | 7500 | Vac |
| Total Device Power Dissipation @ T _A = 25°C Derate above 25°C | P _D | 250 2.94 | mW mW/°C |
| Ambient Operating Temperature Range | T _A | -55 to +100 | °C |
| Storage Temperature Range | T _{stg} | -55 to +150 | °C |
| Soldering Temperature (10 sec, 1/16" from case) | T _{sol} | 260 | °C |

(1) Isolation surge voltage is an internal device dielectric breakdown rating. For this test, Pins 1 and 2 are common, and Pins 4, 5 and 6 are common.

H11AV1,A
H11AV2,A
H11AV3,A

**6-PIN DIP
 OPTOISOLATORS
 TRANSISTOR OUTPUT**

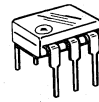

**CASE 730A-02
 PLASTIC**



**CASE 730D-02
 PLASTIC**

SCHEMATIC

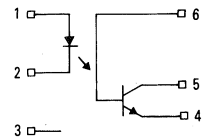

1. LED ANODE
2. LED CATHODE
3. N.C.
4. EMITTER
5. COLLECTOR
6. BASE

H11AV1, H11AV1A, H11AV2, H11AV2A, H11AV3, H11AV3A

ELECTRICAL CHARACTERISTICS ($T_A = 25^\circ\text{C}$ unless otherwise noted)

| Characteristic | Symbol | Min | Typ | Max | Unit |
|----------------|--------|-----|-----|-----|------|
|----------------|--------|-----|-----|-----|------|

INPUT LED

| | | | | | | |
|---|---------------------------|-------|-----|------|-----|---------------|
| Forward Voltage ($I_F = 10\text{ mA}$) | $T_A = 25^\circ\text{C}$ | V_F | 0.8 | 1.15 | 1.5 | Volts |
| | $T_A = -55^\circ\text{C}$ | | 0.9 | 1.3 | 1.7 | |
| | $T_A = 100^\circ\text{C}$ | | 0.7 | 1.05 | 1.4 | |
| Reverse Leakage Current ($V_R = 6\text{ V}$) | | I_R | — | — | 10 | μA |
| Capacitance ($V = 0\text{ V}$, $f = 1\text{ MHz}$) | | C_J | — | 18 | — | pF |

OUTPUT TRANSISTOR

| | | | | | | |
|---|--|---------------|----|-----|----|-------|
| Collector-Emitter Dark Current ($V_{CE} = 10\text{ V}$) | | I_{CEO} | — | 5 | 50 | nA |
| Collector-Base Dark Current ($V_{CB} = 10\text{ V}$) | | I_{CBO} | — | 0.5 | — | nA |
| Collector-Emitter Breakdown Voltage ($I_C = 1\text{ mA}$) | | $V_{(BR)CEO}$ | 70 | 100 | — | Volts |
| Collector-Base Breakdown Voltage ($I_C = 100\text{ }\mu\text{A}$) | | $V_{(BR)CBO}$ | 70 | 100 | — | Volts |
| Emitter-Collector Breakdown Voltage ($I_E = 100\text{ }\mu\text{A}$) | | $V_{(BR)ECO}$ | 7 | 8 | — | Volts |
| DC Current Gain ($I_C = 2\text{ mA}$, $V_{CE} = 10\text{ V}$) | | h_{FE} | — | 500 | — | — |
| Collector-Emitter Capacitance ($f = 1\text{ MHz}$, $V_{CE} = 10\text{ V}$) | | C_{CE} | — | 4.5 | — | pF |

COUPLED

| | | | | | | |
|---|-----------------|---------------|-----------|------|-----|---------------|
| Output Collector Current ($I_F = 10\text{ mA}$, $V_{CE} = 10\text{ V}$) | | I_C | | | | mA |
| | H11AV1, H11AV1A | | 10 | 15 | 30 | |
| | H11AV2, H11AV2A | | 5 | 10 | — | |
| | H11AV3, H11AV3A | | 2 | 7 | — | |
| Collector-Emitter Saturation Voltage ($I_C = 2\text{ mA}$, $I_F = 20\text{ mA}$) | | $V_{CE(sat)}$ | — | 0.15 | 0.4 | Volts |
| Turn-On Time ($I_C = 2\text{ mA}$, $V_{CC} = 10\text{ V}$, $R_L = 100\text{ }\Omega$, Figure 11) | | t_{on} | — | 5 | 15 | μs |
| Turn-Off Time ($I_C = 2\text{ mA}$, $V_{CC} = 10\text{ V}$, $R_L = 100\text{ }\Omega$, Figure 11) | | t_{off} | — | 4 | 15 | μs |
| Isolation Voltage ($f = 60\text{ Hz}$, $t = 1\text{ sec}$) | | V_{ISO} | 7500 | — | — | Vac(pk) |
| Isolation Resistance ($V = 500\text{ V}$) | | R_{ISO} | 10^{11} | — | — | Ω |
| Isolation Capacitance ($V = 0\text{ V}$, $f = 1\text{ MHz}$) | | C_{ISO} | — | 0.2 | 0.5 | pF |

TYPICAL CHARACTERISTICS

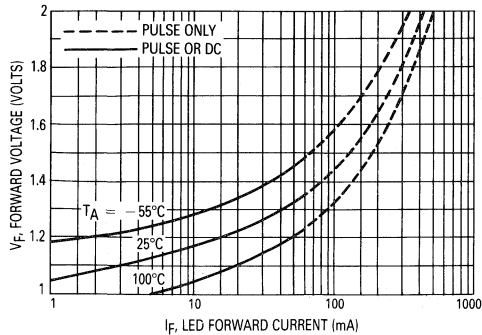

Figure 1. LED Forward Voltage versus Forward Current

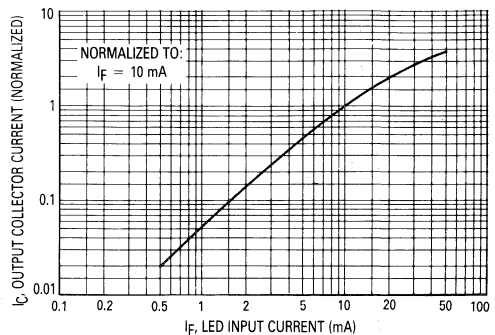

Figure 2. Output Current versus Input Current

H11AV1, H11AV1A, H11AV2, H11AV2A, H11AV3, H11AV3A

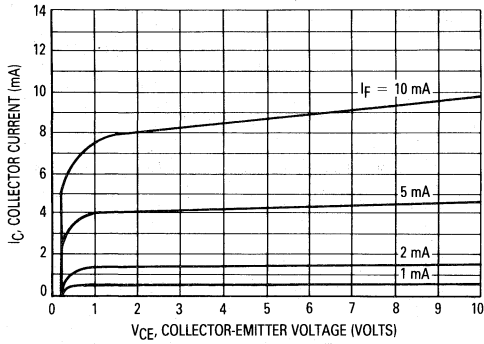

Figure 3. Collector Current versus Collector-Emitter Voltage

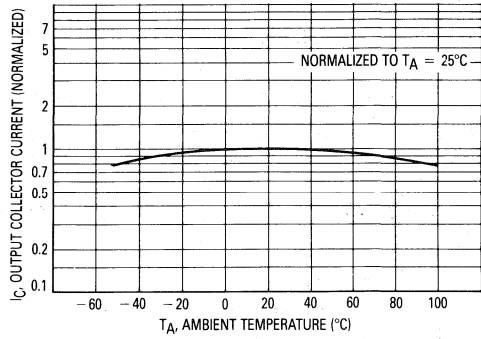

Figure 4. Output Current versus Ambient Temperature

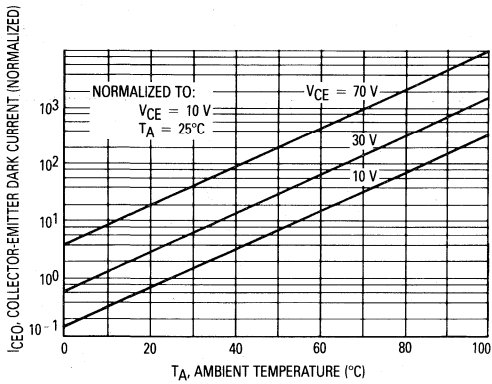

Figure 5. Dark Current versus Ambient Temperature

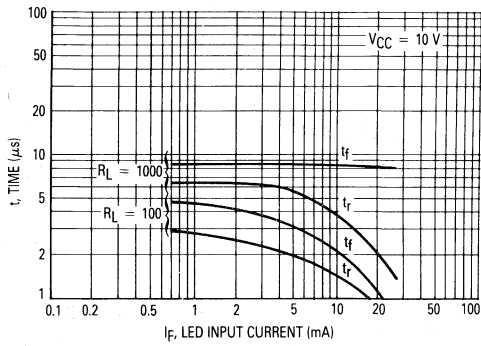

Figure 6. Rise and Fall Times

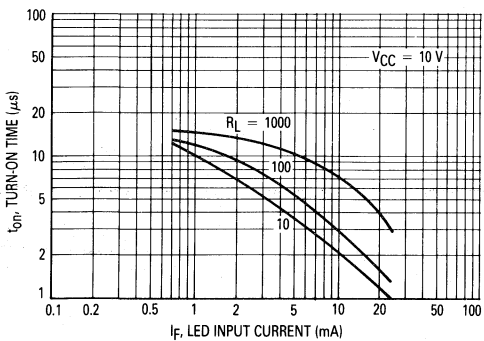

Figure 7. Turn-On Switching Times

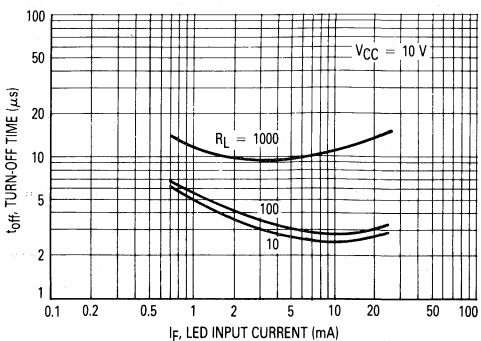

Figure 8. Turn-Off Switching Times

H11AV1, H11AV1A, H11AV2, H11AV2A, H11AV3, H11AV3A

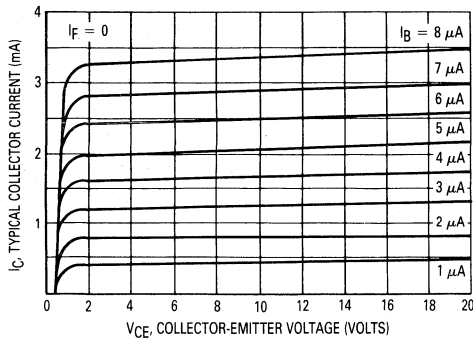

Figure 9. DC Current Gain (Detector Only)

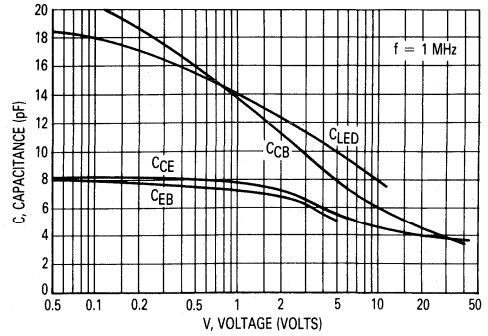

Figure 10. Capacitances versus Voltage

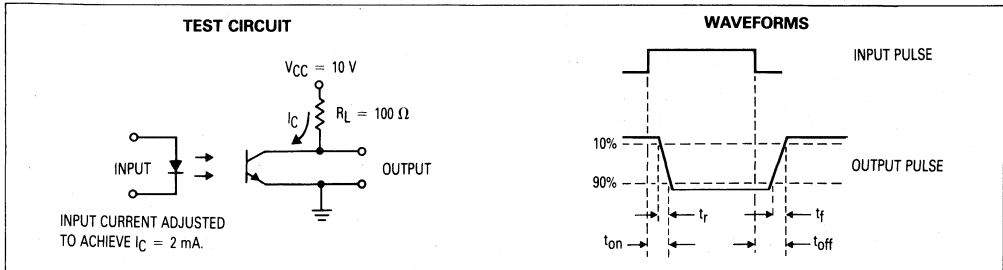
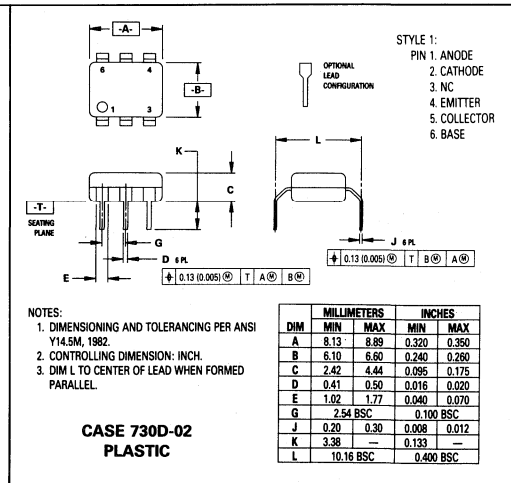
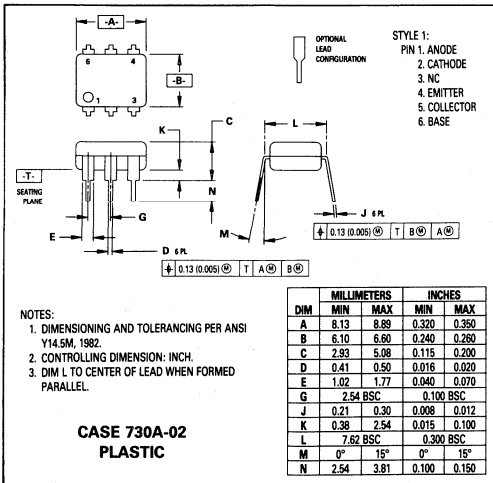



Figure 11. Switching Times

OUTLINE DIMENSIONS



6-Pin DIP Optoisolators Darlington Output

These devices consist of a gallium arsenide infrared emitting diode optically coupled to a monolithic silicon photodarlington detector. They are designed for use in applications requiring high sensitivity at low input currents.

- Convenient Plastic Dual-In-Line Package
- High Sensitivity to Low Input Drive Current
- High Input-Output Isolation Guaranteed — 7500 Volts Peak
- UL Recognized. File Number E54915 
- VDE approved per standard 0883/6.80 (Certificate number 41853), with additional approval to DIN IEC380/VDE0806, IEC435/VDE0805, IEC65/VDE0860, VDE0110b, covering all other standards with equal or less stringent requirements, including IEC204/VDE0113, VDE0160, VDE0832, VDE0833, etc. 
- Special lead form available (add suffix "T" to part number) which satisfies VDE0883/6.80 requirement for 8 mm minimum creepage distance between input and output solder pads.
- Various lead form options available. Consult "Optoisolator Lead Form Options" data sheet for details.

H11B1
H11B2
H11B3

6-PIN DIP
OPTOISOLATORS
DARLINGTON OUTPUT

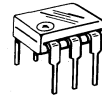

CASE 730A-02
PLASTIC

MAXIMUM RATINGS ($T_A = 25^\circ\text{C}$ unless otherwise noted)

| Rating | Symbol | Value | Unit |
|--------|--------|-------|------|
|--------|--------|-------|------|

INPUT LED

| | | | |
|---|-------|------|-------|
| Reverse Voltage | V_R | 3 | Volts |
| Forward Current — Continuous | I_F | 60 | mA |
| LED Power Dissipation @ $T_A = 25^\circ\text{C}$ with Negligible Power in Output Detector Derate above 25°C | P_D | 150 | mW |
| | | 1.41 | mW/°C |

OUTPUT DETECTOR

| | | | |
|--|-----------|------|-------|
| Collector-Emitter Voltage | V_{CEO} | 25 | Volts |
| Emitter-Base Voltage | V_{EBO} | 7 | Volts |
| Collector-Base Voltage | V_{CBO} | 30 | Volts |
| Collector Current — Continuous | I_C | 100 | mA |
| Detector Power Dissipation @ $T_A = 25^\circ\text{C}$ with Negligible Power in Input LED Derate above 25°C | P_D | 150 | mW |
| | | 1.76 | mW/°C |

TOTAL DEVICE

| | | | |
|--|-----------|-------------|-------------|
| Isolation Surge Voltage (1) (Peak ac Voltage, 60 Hz, 1 sec Duration) | V_{ISO} | 7500 | Vac |
| Total Device Power Dissipation @ $T_A = 25^\circ\text{C}$ Derate above 25°C | P_D | 250 2.94 | mW mW/°C |
| Ambient Operating Temperature Range | T_A | -55 to +100 | °C |
| Storage Temperature Range | T_{stg} | -55 to +150 | °C |
| Soldering Temperature (10 sec, 1/16" from case) | — | 260 | °C |

(1) Isolation surge voltage is an internal device dielectric breakdown rating. For this test, Pins 1 and 2 are common, and Pins 4, 5 and 6 are common.

SCHEMATIC

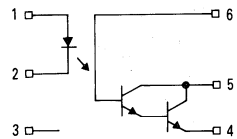

1. LED ANODE
2. LED CATHODE
3. N.C.
4. EMITTER
5. COLLECTOR
6. BASE

H11B1, H11B2, H11B3

ELECTRICAL CHARACTERISTICS ($T_A = 25^\circ\text{C}$ unless otherwise noted)

| Characteristic | Symbol | Min | Typ | Max | Unit | |
|---|--------------|-------|-----|------|------|---------------|
| INPUT LED | | | | | | |
| Forward Voltage ($I_F = 10\text{ mA}$) | H11B1, H11B2 | V_F | — | 1.15 | 1.5 | Volts |
| Forward Voltage ($I_F = 50\text{ mA}$) | H11B3 | V_F | — | 1.34 | 1.5 | Volts |
| Reverse Leakage Current ($V_R = 3\text{ V}$) | | I_R | — | — | 10 | μA |
| Capacitance ($V = 0\text{ V}$, $f = 1\text{ MHz}$) | | C_J | — | 18 | — | pF |

OUTPUT DETECTOR

| | | | | | |
|--|---------------|----|-----|-----|-------|
| Collector-Emitter Dark Current ($V_{CE} = 10\text{ V}$) | I_{CEO} | — | 5 | 100 | nA |
| Collector-Emitter Breakdown Voltage ($I_C = 10\text{ mA}$) | $V_{(BR)CEO}$ | 25 | 80 | — | Volts |
| Collector-Base Breakdown Voltage ($I_C = 100\ \mu\text{A}$) | $V_{(BR)CBO}$ | 30 | 100 | — | Volts |
| Emitter-Collector Breakdown Voltage ($I_E = 100\ \mu\text{A}$) | $V_{(BR)ECO}$ | 7 | — | — | Volts |
| DC Current Gain ($I_C = 5\text{ mA}$, $V_{CE} = 5\text{ V}$) | h_{FE} | — | 16K | — | — |
| Collector-Emitter Capacitance ($f = 1\text{ MHz}$, $V_{CE} = 5\text{ V}$) | C_{CE} | — | 3.9 | — | pF |
| Collector-Base Capacitance ($f = 1\text{ MHz}$, $V_{CB} = 5\text{ V}$) | C_{CB} | — | 6.3 | — | pF |
| Emitter-Base Capacitance ($f = 1\text{ MHz}$, $V_{EB} = 5\text{ V}$) | C_{EB} | — | 3.8 | — | pF |

COUPLED

| | | | | | | |
|--|-------------------------|---------------|-------------|-------------|-------------|---------------|
| Output Collector Current ($I_F = 1\text{ mA}$, $V_{CE} = 5\text{ V}$) | H11B1 H11B2 H11B3 | I_C | 5 2 1 | — — — | — — — | mA |
| Collector-Emitter Saturation Voltage ($I_C = 1\text{ mA}$, $I_F = 1\text{ mA}$) | | $V_{CE(sat)}$ | — | 0.7 | 1 | Volts |
| Turn-On Time ($I_F = 5\text{ mA}$, $V_{CC} = 10\text{ V}$, $R_L = 100\ \Omega$) | | t_{on} | — | 3.5 | — | μs |
| Turn-Off Time ($I_F = 5\text{ mA}$, $V_{CC} = 10\text{ V}$, $R_L = 100\ \Omega$) | | t_{off} | — | 95 | — | μs |
| Rise Time ($I_F = 5\text{ mA}$, $V_{CC} = 10\text{ V}$, $R_L = 100\ \Omega$) | | t_r | — | 1 | — | μs |
| Fall Time ($I_F = 5\text{ mA}$, $V_{CC} = 10\text{ V}$, $R_L = 100\ \Omega$) | | t_f | — | 2 | — | μs |
| Isolation Voltage ($f = 60\text{ Hz}$, $t = 1\text{ sec}$) (2) | | V_{ISO} | 7500 | — | — | Vac(pk) |
| Isolation Resistance ($V = 500\text{ V}$) (2) | | R_{ISO} | 10^{11} | — | — | Ω |
| Isolation Capacitance ($V = 0\text{ V}$, $f = 1\text{ MHz}$) (2) | | C_{ISO} | — | 0.2 | — | pF |

Note 2. For this test, Pins 1 and 2 are common, and Pins 4, 5 and 6 are common.

6

TYPICAL CHARACTERISTICS

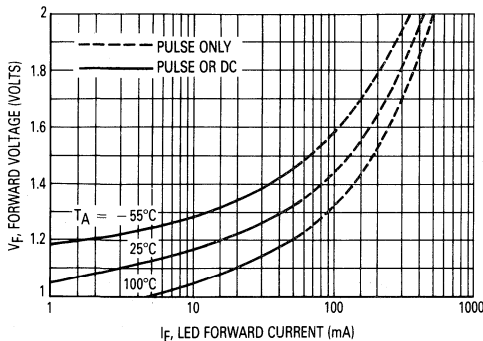

Figure 1. LED Forward Voltage versus Forward Current

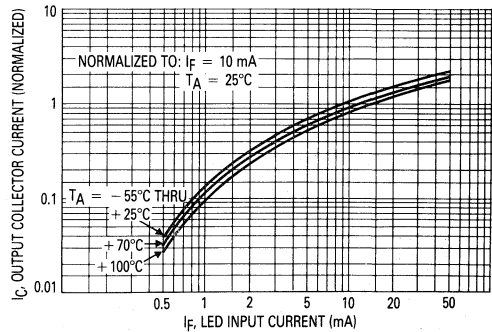

Figure 2. Output Current versus Input Current

H11B1, H11B2, H11B3

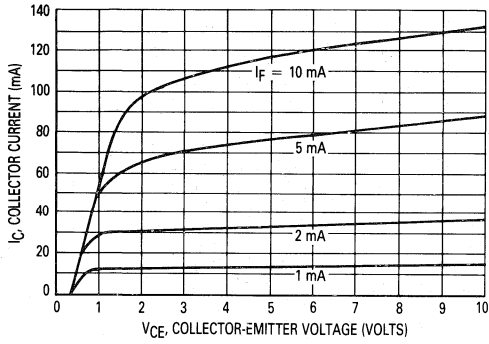

Figure 3. Collector Current versus Collector-Emitter Voltage

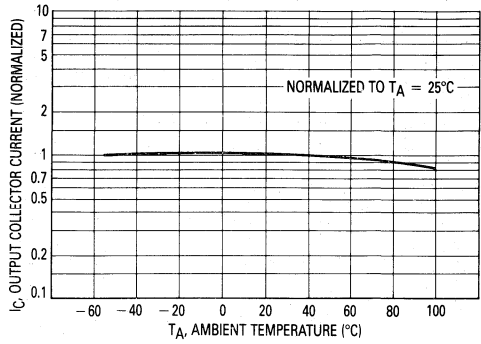

Figure 4. Output Current versus Ambient Temperature

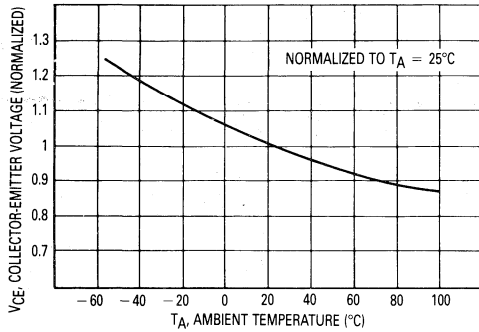

Figure 5. Collector-Emitter Voltage versus Ambient Temperature

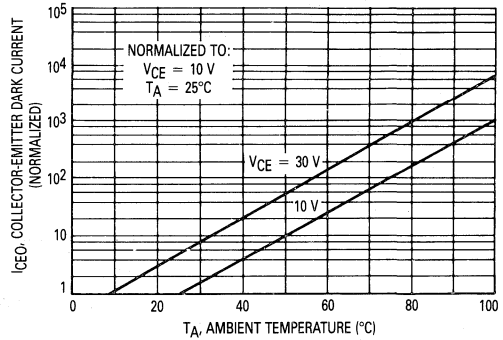

Figure 6. Collector-Emitter Dark Current versus Ambient Temperature

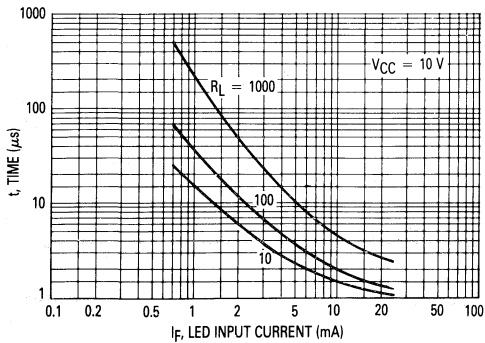

Figure 7. Turn-On Switching Times

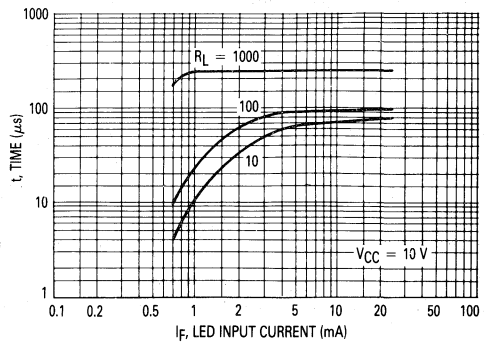

Figure 8. Turn-Off Switching Times

H11B1, H11B2, H11B3

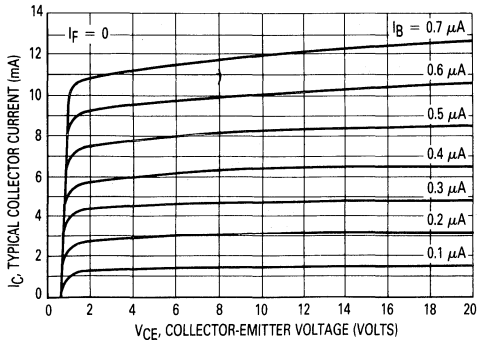

Figure 9. DC Current Gain (Detector Only)

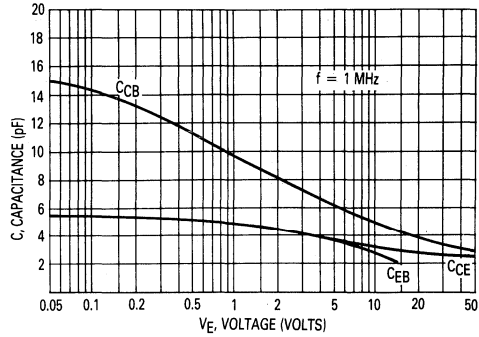

Figure 10. Detector Capacitances versus Voltage

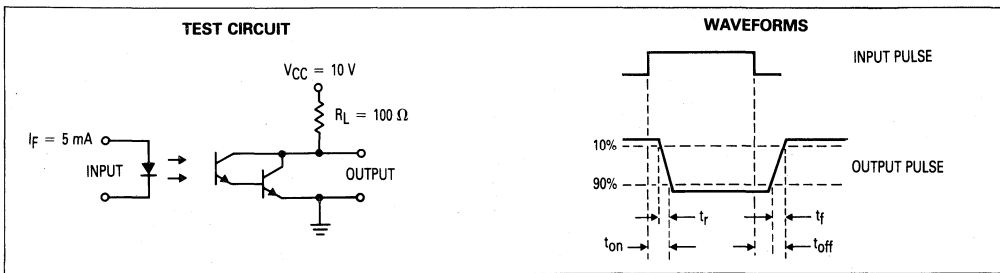
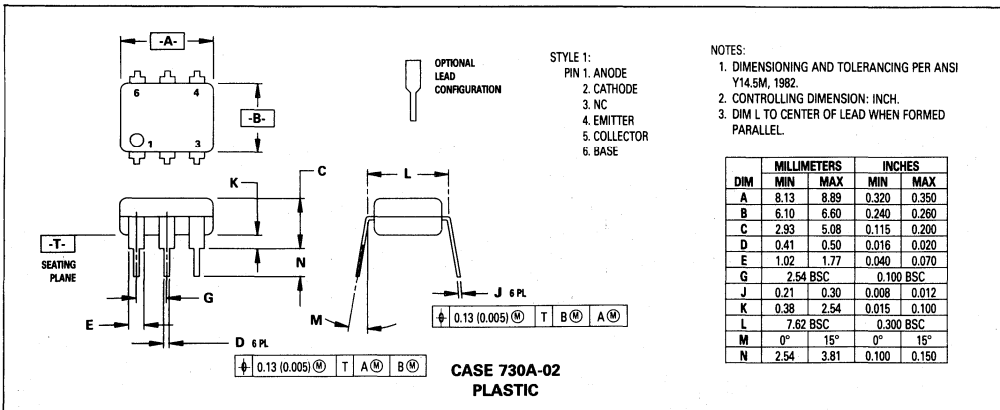



Figure 11. Switching Times

OUTLINE DIMENSIONS



6-Pin DIP Optoisolators SCR Output

These devices consist of gallium-arsenide infrared emitting diodes optically coupled to photo sensitive silicon controlled rectifiers (SCR). They are designed for applications requiring high electrical isolation between low voltage circuitry, like integrated circuits, and the ac line.

- High Blocking Voltage of 200 V for 120 Vac Lines
- Very High Isolation: $V_{ISO} = 7500 \text{ Vac (pk) Min}$
- Standard 6-Pin DIP
- UL Recognized, File Number E54915 
- VDE approved per standard 0883/6.80 (Certificate number 41853), with additional approval to DIN IEC380/VDE0806, IEC435/VDE0805, IEC65/VDE0860, VDE110b, covering all other standards with equal or less stringent requirements, including IEC204/ 883, VDE0113, VDE0160, VDE0832, VDE0833, etc.
- Special lead form available (add suffix "T" to part number) which satisfies VDE0883/6.80 requirement for 8 mm minimum creepage distance between input and output solder pads.
- Various lead form options available. Consult "Optoisolator Lead Form Options" data sheet for details.

MAXIMUM RATINGS ($T_A = 25^\circ\text{C}$ unless otherwise noted)

| Rating | Symbol | Value | Unit |
|--------|--------|-------|------|
|--------|--------|-------|------|

INPUT LED

| | | | |
|---|-------|-------------|-------------|
| Reverse Voltage | V_R | 7 | Volts |
| Forward Current — Continuous | I_F | 60 | mA |
| LED Power Dissipation @ $T_A = 25^\circ\text{C}$ Derate above 25°C | P_D | 120 1.41 | mW mW/°C |

OUTPUT DETECTOR

| | | | |
|--|-------------------|-------------|-------------|
| Peak Forward Voltage | V_{DM} | 200 | Volts |
| Forward RMS Current (Full Cycle, 50 to 60 Hz) $T_A = 25^\circ\text{C}$ | $I_T(\text{RMS})$ | 300 | mA |
| Peak Nonrepetitive Surge Current (PW = 10 ms) | I_{TSM} | 3 | A |
| Detector Power Dissipation @ $T_A = 25^\circ\text{C}$ Derate above 25°C | P_D | 150 1.76 | mW mW/°C |

TOTAL DEVICE

| | | | |
|--|-----------|-------------|-------------|
| Isolation Surge Voltage (1) (Peak ac Voltage, 60 Hz, 1 Second Duration) | V_{ISO} | 7500 (2) | Vac |
| Total Device Power Dissipation @ $T_A = 25^\circ\text{C}$ Derate above 25°C | P_D | 250 2.94 | mW mW/°C |
| Junction Temperature Range | T_J | -40 to +100 | °C |
| Ambient Operating Temperature Range | T_A | -55 to +100 | °C |
| Storage Temperature Range | T_{stg} | -55 to +150 | °C |
| Soldering Temperature (10 s) | — | 260 | °C |

(1) Isolation surge voltage, V_{ISO} , is an internal device dielectric breakdown rating.
 (2) Originator's Specifications are: H11C1 — 2500 V, H11C2 and H11C3 — 2100 V.

**H11C1
 H11C2
 H11C3**

**6-PIN DIP
 OPTOISOLATORS
 SCR OUTPUT
 200 VOLTS**

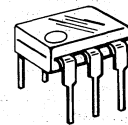

**CASE 730A-02
 PLASTIC**

SCHEMATIC

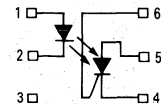

1. LED ANODE
2. LED CATHODE
3. NC
4. SCR CATHODE
5. SCR ANODE
6. SCR GATE

H11C1, H11C2, H11C3

ELECTRICAL CHARACTERISTICS ($T_A = 25^\circ\text{C}$ unless otherwise noted)

| Characteristic | Symbol | Min | Typ | Max | Unit |
|----------------|--------|-----|-----|-----|------|
|----------------|--------|-----|-----|-----|------|

INPUT LED

| | | | | | |
|--|-------|---|------|-----|---------------|
| Reverse Leakage Current ($V_R = 3\text{ V}$) | I_R | — | 0.05 | 10 | μA |
| Forward Voltage ($I_F = 10\text{ mA}$) | V_F | — | 1.2 | 1.5 | Volts |
| Capacitance ($V = 0\text{ V}$, $f = 1\text{ MHz}$) | C_J | — | 18 | — | pF |

OUTPUT DETECTOR

| | | | | | |
|---|----------|-----|-----------|-----|---------------|
| Peak Off-State Voltage ($R_{GK} = 10\text{ k}\Omega$, $T_A = 100^\circ\text{C}$) | V_{DM} | 200 | — | — | Volts |
| Peak Reverse Voltage ($R_{GK} = 10\text{ k}\Omega$, $T_A = 100^\circ\text{C}$) | V_{RM} | 200 | — | — | Volts |
| On-State Voltage ($I_{TM} = 0.3\text{ A}$) | V_{TM} | — | 1.1 | 1.3 | Volts |
| Off-State Current ($V_{DM} = 200\text{ V}$, $T_A = 100^\circ\text{C}$) | I_{DM} | — | — | 50 | μA |
| Reverse Current ($V_{RM} = 200\text{ V}$, $T_A = 100^\circ\text{C}$) | I_{RM} | — | — | 50 | μA |
| Capacitance ($V = 0\text{ V}$, $f = 1\text{ MHz}$) Anode — Gate Gate — Cathode | C_J | — | 20 350 | — | pF |

COUPLED

| | | | | | | |
|--|-----------------------|-----------|--------|----------|----------|----------------------|
| LED Current Required to Trigger ($V_{AK} = 50\text{ V}$, $R_{GK} = 10\text{ k}\Omega$) | H11C1, H11C2 H11C3 | I_{FT} | — — | 10 15 | 20 30 | mA |
| ($V_{AK} = 100\text{ V}$, $R_{GK} = 27\text{ k}\Omega$) | H11C1, H11C2 H11C3 | | — — | 6 8 | 11 14 | |
| Isolation Resistance ($V_{IO} = 500\text{ Vdc}$) | | R_{ISO} | 100 | — | — | $\text{G}\Omega$ |
| Capacitance Input to Output ($V_{IO} = 0$, $f = 1\text{ MHz}$) | | C_{ISO} | — | 0.2 | 2 | pF |
| Coupled dv/dt , Input to Output ($R_{GK} = 10\text{ k}\Omega$) | | dv/dt | — | 500 | — | Volts/ μs |
| Isolation Surge Voltage (Peak ac Voltage, 60 Hz, 1 Second Duration) | | V_{ISO} | 7500 | — | — | Vac(pk) |

H11C1, H11C2, H11C3

TYPICAL ELECTRICAL CHARACTERISTICS

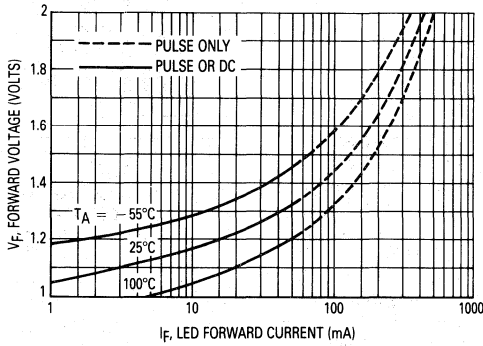

Figure 1. LED Forward Voltage versus Forward Current

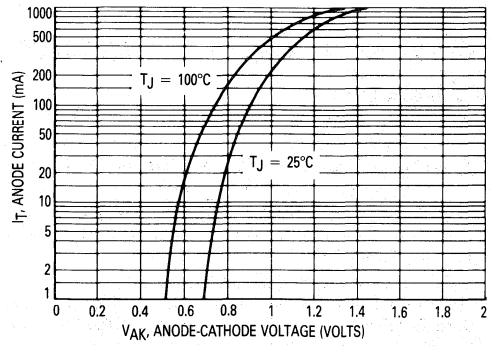

Figure 2. Anode Current versus Anode-Cathode Voltage

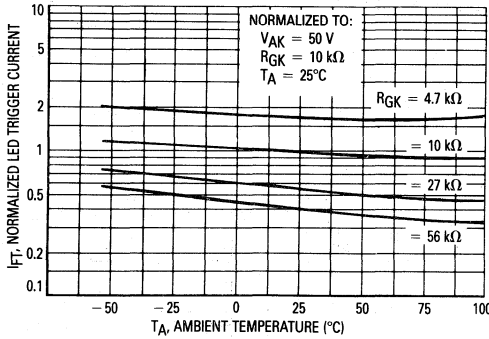

Figure 3. LED Trigger Current versus Temperature

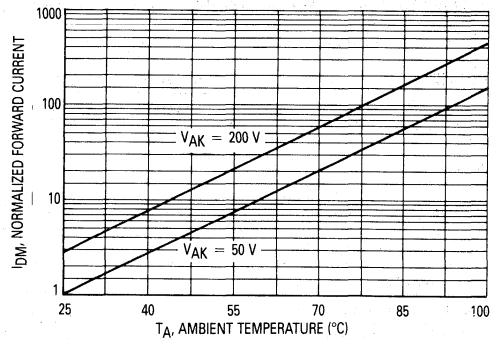
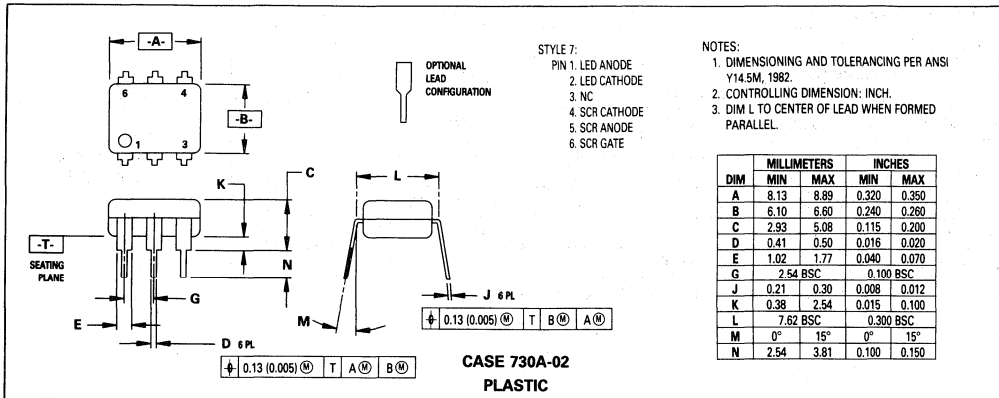



Figure 4. Forward Leakage Current versus Temperature

OUTLINE DIMENSIONS



6-Pin DIP Optoisolators SCR Output

These devices consist of gallium-arsenide infrared emitting diodes optically coupled to photo sensitive silicon controlled rectifiers (SCR). They are designed for applications requiring high electrical isolation between low voltage control circuitry and the ac line.

- High Blocking Voltage of 400 V for 240 Vac Lines
- Very High Isolation Voltage: $V_{ISO} = 7500$ Vac (pk) Min
- Standard 6-Pin DIP
- UL Recognized, File Number E54915 
- VDE approved per standard 0883/6.80 (Certificate number 41853), with additional approval to DIN IEC380/VDE0806, IEC435/VDE0805, IEC65/VDE0860, VDE110b, covering all other standards with equal or less stringent requirements, including IEC204/VDE0113, VDE0160, VDE0832, VDE0833, etc. 
- Special lead form available (add suffix "T" to part number) which satisfies VDE0883/6.80 requirement for 8 mm minimum creepage distance between input and output solder pads.
- Various lead form options available. Consult "Optoisolator Lead Form Options" data sheet for details.

MAXIMUM RATINGS ($T_A = 25^\circ\text{C}$ unless otherwise noted)

| | Rating | Symbol | Value | Unit |
|--|--------|-------------------|-------------|----------------------------|
| INPUT LED | | | | |
| Reverse Voltage | | V_R | 6 | Volts |
| Forward Current — Continuous | | I_F | 60 | mA |
| LED Power Dissipation @ $T_A = 25^\circ\text{C}$ Derate above 25°C | | P_D | 120 1.41 | mW mW/ $^\circ\text{C}$ |
| OUTPUT DETECTOR | | | | |
| Peak Forward Voltage | | V_{DM} | 400 | Volts |
| Forward RMS Current (Full Cycle, 50 to 60 Hz) $T_A = 25^\circ\text{C}$ | | $I_T(\text{RMS})$ | 300 | mA |
| Peak Nonrepetitive Surge Current (PW = 10 ms) | | I_{TSM} | 3 | A |
| Detector Power Dissipation @ $T_A = 25^\circ\text{C}$ Derate above 25°C | | P_D | 150 1.76 | mW mW/ $^\circ\text{C}$ |

TOTAL DEVICE

| | | | |
|--|-----------|-------------|----------------------------|
| Isolation Surge Voltage (1) (Peak ac Voltage, 60 Hz, 1 Second Duration) | V_{ISO} | 7500 | Vac |
| Total Device Power Dissipation @ $T_A = 25^\circ\text{C}$ Derate above 25°C | P_D | 250 2.94 | mW mW/ $^\circ\text{C}$ |
| Junction Temperature Range | T_J | -40 to +100 | $^\circ\text{C}$ |
| Ambient Operating Temperature Range | T_A | -55 to +100 | $^\circ\text{C}$ |
| Storage Temperature Range | T_{stg} | -55 to +150 | $^\circ\text{C}$ |
| Soldering Temperature (10 s, 1/16" from case) | — | 260 | $^\circ\text{C}$ |

(1) Isolation surge voltage, V_{ISO} , is an internal device dielectric breakdown rating.

H11C4
H11C5
H11C6

6-PIN DIP
OPTOISOLATORS
SCR OUTPUT
400 VOLTS

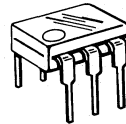

CASE 730A-02
PLASTIC

SCHEMATIC

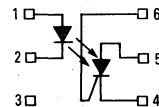

1. ANODE
2. CATHODE
3. NC
4. SCR CATHODE
5. SCR ANODE
6. SCR GATE

H11C4, H11C5, H11C6

ELECTRICAL CHARACTERISTICS ($T_A = 25^\circ\text{C}$ unless otherwise noted)

| Characteristic | Symbol | Min | Typ | Max | Unit |
|----------------|--------|-----|-----|-----|------|
|----------------|--------|-----|-----|-----|------|

INPUT LED

| | | | | | |
|---|-------|---|------|-----|---------------|
| Reverse Leakage Current ($V_R = 3\text{ V}$) | I_R | — | 0.05 | 10 | μA |
| Forward Voltage ($I_F = 10\text{ mA}$) | V_F | — | 1.2 | 1.5 | Volts |
| Capacitance ($V = 0\text{ V}, f = 1\text{ MHz}$) | C_J | — | 18 | — | pF |

OUTPUT DETECTOR

| | | | | | |
|---|----------|-----|-----------|-----|---------------|
| Peak Off-State Voltage ($R_{GK} = 10\text{ k}\Omega, T_A = 100^\circ\text{C}$) | V_{DM} | 400 | — | — | Volts |
| Peak Reverse Voltage ($R_{GK} = 10\text{ k}\Omega, T_A = 100^\circ\text{C}$) | V_{RM} | 400 | — | — | Volts |
| On-State Voltage ($I_{TM} = 0.3\text{ A}$) | V_{TM} | — | 1.1 | 1.3 | Volts |
| Off-State Current ($V_{DM} = 400\text{ V}, T_A = 100^\circ\text{C}, R_{GK} = 10\text{ k}\Omega$) | I_{DM} | — | — | 150 | μA |
| Reverse Current ($V_{RM} = 400\text{ V}, T_A = 100^\circ\text{C}, R_{GK} = 10\text{ k}\Omega$) | I_{RM} | — | — | 150 | μA |
| Capacitance ($V = 0\text{ V}, f = 1\text{ MHz}$) Anode - Gate Gate - Cathode | C_J | — | 20 350 | — | pF |

COUPLED

| | | | | | | |
|---|-----------|-----------------------|------|-----|----|----------------------|
| LED Current Required to Trigger ($V_{AK} = 50\text{ V}, R_{GK} = 10\text{ k}\Omega$) | I_{FT} | H11C4, H11C5 H11C6 | — | 10 | 20 | mA |
| ($V_{AK} = 100\text{ V}, R_{GK} = 27\text{ k}\Omega$) | | | — | 15 | 30 | |
| | | H11C4, H11C5 H11C6 | — | 6 | 11 | |
| | | | — | 8 | 14 | |
| Isolation Resistance ($V_{IO} = 500\text{ Vdc}$) | R_{ISO} | | 100 | — | — | $\text{G}\Omega$ |
| Capacitance Input to Output ($V_{IO} = 0, f = 1\text{ MHz}$) | C_{ISO} | | — | 0.2 | 2 | pF |
| Coupled dv/dt , Input to Output ($R_{GK} = 10\text{ k}\Omega$) | dv/dt | | — | 500 | — | Volts/ μs |
| Isolation Surge Voltage (Peak ac Voltage, 60 Hz, 1 Second Duration) | V_{ISO} | | 7500 | — | — | Vac(pk) |

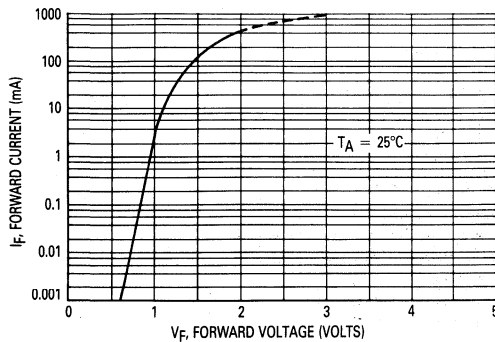

Figure 1. Forward Current versus LED Forward Voltage

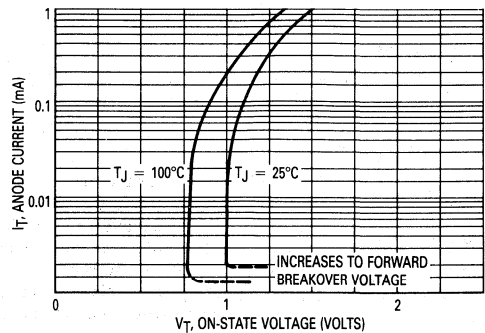

Figure 2. On-State Characteristics

H11C4, H11C5, H11C6

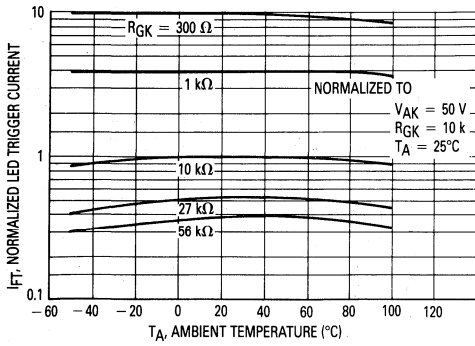

Figure 3. LED Trigger Current versus Temperature

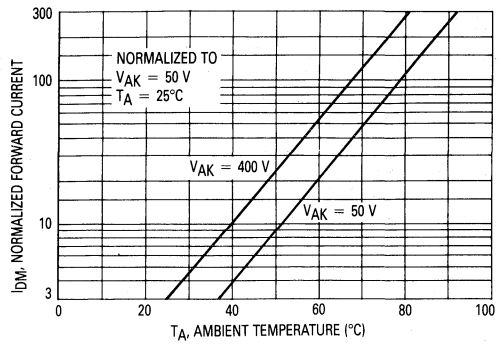
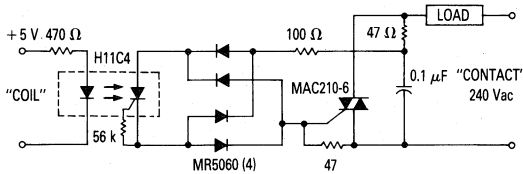

Figure 4. Forward Leakage Current versus Temperature

TYPICAL APPLICATIONS



Use of the H11C4 for high sensitivity, 7500 V isolation capability, provides this highly reliable solid state relay design. This design is compatible with 74, 74S and 74H series T²L logic systems inputs and 240 Vac loads up to 10 A.

Figure 5. 10 A, T²L Compatible, Solid State Relay

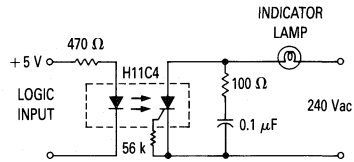

The high surge capability and non-reactive input characteristics of the H11C allow it to directly couple, without buffers, T²L and DTL logic to indicator and alarm devices, without danger of introducing noise and logic glitches.

Figure 6. 25 W Logic Indicator Lamp Driver

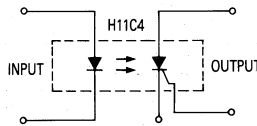

Use of the high voltage PNP portion of the H11C provides a 400 V transistor capable of conducting positive and negative signals with current transfer ratios of over 1%. This function is useful in remote instrumentation, high voltage power supplies and test equipment. Care should be taken not to exceed the H11C 400 mW power dissipation rating when used at high voltages.

Figure 7. 400 V Symmetrical Transistor Coupler

H11C4, H11C5, H11C6

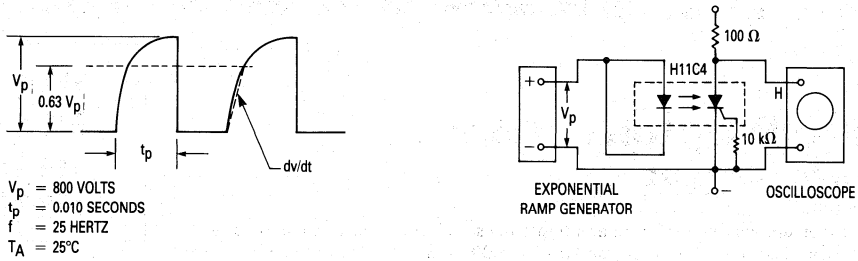
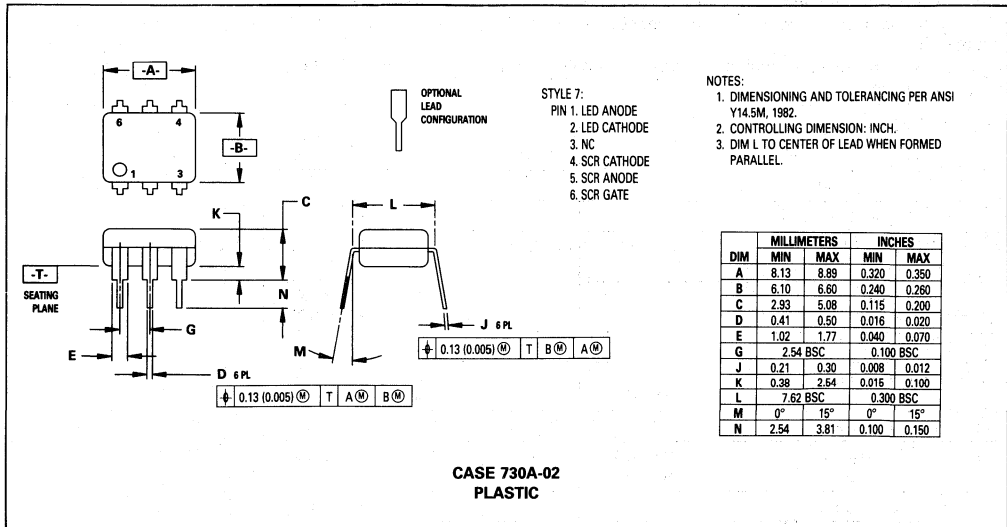

Figure 8. Coupled dv/dt — Test Circuit



OUTLINE DIMENSIONS



6

6-Pin DIP Optoisolators Transistor Output

... consist of gallium-arsenide infrared emitting diodes optically coupled to high voltage, silicon, phototransistor detectors in a standard 6-pin DIP package. They are designed for applications requiring high voltage output and are particularly useful in copy machines and solid state relays.

- High Voltage — H11D1,2 — 300 V
 — H11D3,4 — 200 V
- High Isolation Voltage — $V_{ISO} = 7500$ Vac pk Min
- Standard 6-Pin DIP Package
- UL Recognized, File Number E54915 
- VDE approved per standard 0883/6.80 (Certificate number 41853), with additional approval to DIN IEC380/VDE0806, IEC435/VDE0805, IEC65/VDE0860, VDE110b, covering all other standards with equal or less stringent requirements, including IEC204/ 883, VDE0113, VDE0160, VDE0832, VDE0833, etc.
- Special lead form available (add suffix "T" to part number) which satisfies VDE0883/6.80 requirement for 8 mm minimum creepage distance between input and output solder pads.
- Various lead form options available. Consult "Optoisolator Lead Form Options" data sheet for details.

MAXIMUM RATINGS ($T_A = 25^\circ\text{C}$ unless otherwise noted)

| Rating | Symbol | Value | Unit |
|--------|--------|-------|------|
|--------|--------|-------|------|

INPUT LED

| | | | |
|---|-------|-------------|----------------------------|
| Forward Current — Continuous | I_F | 60 | mA |
| Forward Current — Peak Pulse Width = 1 μs , 330 pps | I_F | 1.2 | Amps |
| LED Power Dissipation @ $T_A = 25^\circ\text{C}$ Derate above 25°C | P_D | 120 1.41 | mW mW/ $^\circ\text{C}$ |

OUTPUT TRANSISTOR

| | | | | |
|--|--------------------|-----------|-------------|----------------------------|
| Collector-Emitter Voltage | H11D1,2 H11D3,4 | V_{CER} | 300 200 | Volts |
| Emitter-Collector Voltage | | V_{ECO} | 7 | Volts |
| Collector-Base Voltage | H11D1,2 H11D3,4 | V_{CBO} | 300 200 | Volts |
| Collector Current — Continuous | | I_C | 100 | mA |
| Detector Power Dissipation @ $T_A = 25^\circ\text{C}$ Derate above 25°C | | P_D | 150 1.76 | mW mW/ $^\circ\text{C}$ |

TOTAL DEVICE

| | | | |
|--|-----------|-------------|----------------------------|
| Total Device Power Dissipation @ $T_A = 25^\circ\text{C}$ Derate above 25°C | P_D | 250 2.94 | mW mW/ $^\circ\text{C}$ |
| Operating Temperature Range | T_J | -55 to +100 | $^\circ\text{C}$ |
| Storage Temperature Range | T_{stg} | -55 to +150 | $^\circ\text{C}$ |
| Soldering Temperature (10 s) | T_{sol} | 260 | $^\circ\text{C}$ |
| Isolation Surge Voltage Peak ac Voltage, 60 Hz, 1 Second Duration (1) | V_{ISO} | 7500 | Vac(pk) |

(1) Isolation surge voltage is an internal device dielectric breakdown rating.

H11D1
H11D2
H11D3
H11D4

6-PIN DIP
OPTOISOLATORS
TRANSISTOR OUTPUT
200 AND 300 VOLTS

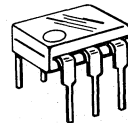

CASE 730A-02
PLASTIC

SCHEMATIC

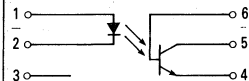

1. ANODE
2. CATHODE
3. NC
4. EMITTER
5. COLLECTOR
6. BASE

H11D1, H11D2, H11D3, H11D4

ELECTRICAL CHARACTERISTICS

| Characteristic | Symbol | Min | Typ | Max | Unit |
|---|--------|-----|-----|-----|---------------|
| INPUT LED ($T_A = 25^\circ\text{C}$ unless otherwise noted) | | | | | |
| Reverse Leakage Current ($V_R = 6\text{ V}$) | I_R | — | — | 10 | μA |
| Forward Voltage ($I_F = 10\text{ mA}$) | V_F | — | 1.2 | 1.5 | Volts |
| Capacitance ($V = 0\text{ V}, f = 1\text{ MHz}$) | C | — | 18 | — | pF |

OUTPUT TRANSISTOR ($T_A = 25^\circ\text{C}$ and $I_F = 0$ unless otherwise noted)

| | | | | | | |
|---|-----------------------------------|---------------|-------------|-------------|-------------------|---------------------------|
| Collector-Emitter Dark Current ($R_{BE} = 1\text{ M}\Omega$) ($V_{CE} = 200\text{ V}, T_A = 25^\circ\text{C}$) ($V_{CE} = 100\text{ V}, T_A = 25^\circ\text{C}$) ($T_A = 100^\circ\text{C}$) | H11D1,2 H11D3,4 All Devices | I_{CER} | — — — | — — — | 100 100 250 | nA nA μA |
| Collector-Base Breakdown Voltage ($I_C = 100\ \mu\text{A}$) | H11D1,2 H11D3,4 | $V_{(BR)CBO}$ | — — | — — | 300 200 | Volts |
| Collector-Emitter Breakdown Voltage ($I_C = 1\text{ mA}, R_{BE} = 1\text{ M}\Omega$) | H11D1,2 H11D3,4 | $V_{(BR)CER}$ | — — | — — | 300 200 | Volts |
| Emitter-Base Breakdown Voltage ($I_E = 100\ \mu\text{A}$) | | $V_{(BR)EBO}$ | 7 | — | — | Volts |

COUPLED ($T_A = 25^\circ\text{C}$ unless otherwise noted)

| | | | | | | |
|--|--|---------------|----------|-----------|--------|---------------|
| Current Transfer Ratio ($V_{CE} = 10\text{ V}, I_F = 10\text{ mA}, R_{BE} = 1\text{ M}\Omega$) | H11D1,2,3 H11D4 | CTR | 20 10 | — — | — — | % |
| Surge Isolation Voltage (Input to Output) (1) Peak ac Voltage, 60 Hz, 1 sec | | V_{ISO} | 7500 | — | — | Volts |
| Isolation Resistance (1) ($V = 500\text{ V}$) | | R_{ISO} | — | 10^{11} | — | Ohms |
| Collector-Emitter Saturation Voltage ($I_C = 0.5\text{ mA}, I_F = 10\text{ mA}, R_{BE} = 1\text{ M}\Omega$) | | $V_{CE(sat)}$ | — | — | 0.4 | Volts |
| Isolation Capacitance (1) ($V = 0, f = 1\text{ MHz}$) | | C_{ISO} | — | 0.2 | — | pF |
| Turn-On Time | $V_{CC} = 10\text{ V}, I_C = 2\text{ mA}, R_L = 100\ \Omega$ | t_{on} | — | 5 | — | μs |
| Turn-Off Time | | t_{off} | — | 5 | — | μs |

NOTE: 1. For this test LED Pins 1 and 2 are common and phototransistor Pins 4, 5, and 6 are common.

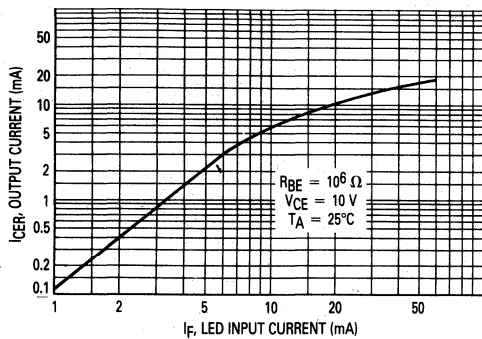

Figure 1. Output Current versus LED Input Current

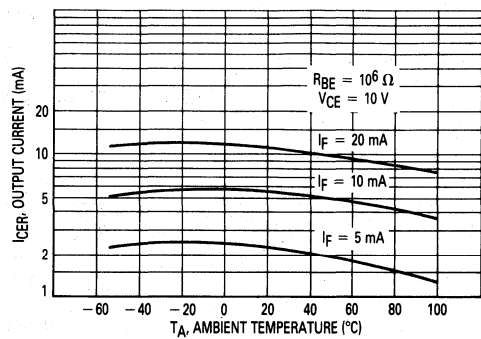

Figure 2. Output Current versus Temperature

H11D1, H11D2, H11D3, H11D4

TYPICAL ELECTRICAL CHARACTERISTICS

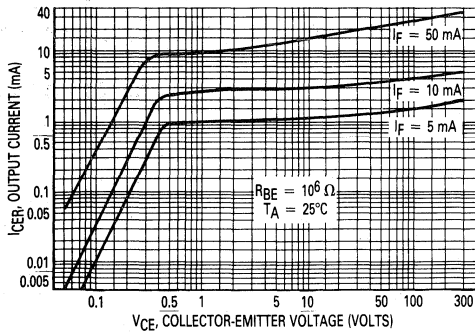

Figure 3. Output Characteristics

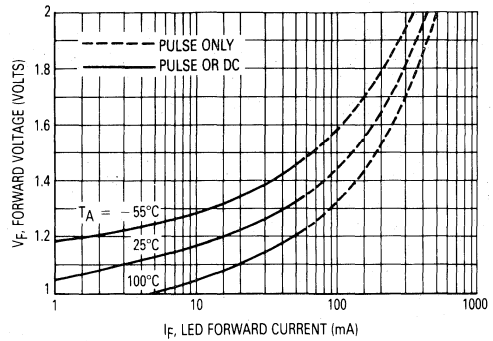

Figure 4. Forward Characteristics

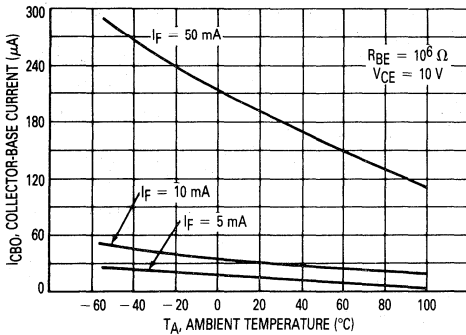

Figure 5. Collector-Base Current versus Temperature

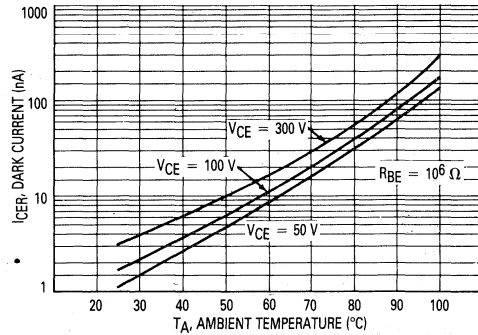

Figure 6. Dark Current versus Temperature

6

OUTLINE DIMENSIONS

OPTIONAL LEAD CONFIGURATION

STYLE 8:
 PIN 1. LED 1 ANODE/LED 2 CATHODE
 2. LED 1 CATHODE/LED 2 ANODE
 3. NC
 4. EMITTER
 5. COLLECTOR
 6. BASE

NOTES:
 1. DIMENSIONING AND TOLERANCING PER ANSI Y14.5M, 1982.
 2. CONTROLLING DIMENSION: INCH.
 3. DIM L TO CENTER OF LEAD WHEN FORMED PARALLEL.

| DIM | MILLIMETERS | | INCHES | |
|-----|-------------|------|-----------|-------|
| | MIN | MAX | MIN | MAX |
| A | 8.13 | 8.89 | 0.320 | 0.350 |
| B | 6.10 | 6.60 | 0.240 | 0.260 |
| C | 2.93 | 5.08 | 0.115 | 0.200 |
| D | 0.41 | 0.50 | 0.016 | 0.020 |
| E | 1.02 | 1.77 | 0.040 | 0.070 |
| G | 2.54 BSC | | 0.100 BSC | |
| J | 0.21 | 0.30 | 0.008 | 0.012 |
| K | 0.38 | 2.54 | 0.015 | 0.100 |
| L | 7.62 BSC | | 0.300 BSC | |
| M | 0° | 15° | 0° | 15° |
| N | 2.54 | 3.81 | 0.100 | 0.150 |

SEATING PLANE



±0.13 (0.005) (M) T A (M) B (M)

±0.13 (0.005) (M) T A (M) B (M)

CASE 730A-02
PLASTIC

6-Pin DIP Optoisolators Darlingtion Output

... consists of gallium-arsenide IREs optically coupled to silicon photodarlington detectors which have integral base-emitter resistors. The on-chip resistors improve higher temperature leakage characteristics. Designed with high isolation, high CTR, high voltage and low leakage, they provide excellent performance in interfacing and coupling systems, phase and feedback controls, solid state relays and general purpose switching circuits.

- High CTR, H11G1 — 1000%, H11G2 — 500%
- High Isolation, $V_{ISO} = 7500$ Vac pk Min
- High $V_{(BR)CEO}$, H11G1 — 100 V, H11G2 — 80 V
- Standard, Economical, 6-Pin DIP Package
- UL Recognized — File Number E54915 
- VDE approved per standard 0883/6.80 (Certificate number 41853), with additional approval to DIN IEC380/VDE0806, IEC435/VDE0805, IEC65/VDE0860, VDE110b, covering all other standards with equal or less stringent requirements, including IEC204/VDE0113, VDE0160, VDE0832, VDE0833, etc. 
- Special lead form available (add suffix "T" to part number) which satisfies VDE0883/6.80 requirement for 8 mm minimum creepage distance between input and output solder pads.
- Various lead form options available. Consult "Optoisolator Lead Form Options" data sheet for details.

MAXIMUM RATINGS ($T_A = 25^\circ\text{C}$ unless otherwise noted)

| Rating | Symbol | Value | Unit |
|--------|--------|-------|------|
|--------|--------|-------|------|

INPUT LED

| | | | |
|---|-------|-------------|----------------------------|
| Reverse Voltage | V_R | 6 | Volts |
| Forward Current — Continuous | I_F | 60 | mA |
| Forward Current — Peak Pulse Width = 300 μs , 2% Duty Cycle | I_F | 3 | Amps |
| LED Power Dissipation @ $T_A = 25^\circ\text{C}$ Derate above 25°C | P_D | 120 1.41 | mW mW/ $^\circ\text{C}$ |

OUTPUT DETECTOR

| | | | |
|--|-----------|-----------------|----------------------------|
| Collector-Emitter Voltage | V_{CEO} | 100 80 55 | Volts |
| Emitter-Base Voltage | V_{EBO} | 7 | Volts |
| Collector Current — Continuous | I_C | 150 | mA |
| Detector Power Dissipation @ $T_A = 25^\circ\text{C}$ Derate above 25°C | P_D | 150 1.76 | mW mW/ $^\circ\text{C}$ |

TOTAL DEVICE

| | | | |
|--|-----------|-------------|----------------------------|
| Total Device Power Dissipation @ $T_A = 25^\circ\text{C}$ Derate above 25°C | P_D | 250 2.94 | mW mW/ $^\circ\text{C}$ |
| Operating Junction Temperature Range | T_J | -55 to +100 | $^\circ\text{C}$ |
| Storage Temperature Range | T_{stg} | -55 to +150 | $^\circ\text{C}$ |
| Soldering Temperature (10 s) | — | 260 | $^\circ\text{C}$ |
| Isolation Surge Voltage (1) (Peak ac Voltage, 60 Hz, 1 sec Duration) | V_{ISO} | 7500 | Vac(pk) |

(1) Isolation surge voltage is an internal device dielectric breakdown rating.

H11G1
H11G2
H11G3

**6-PIN DIP
 OPTOISOLATORS
 DARLINGTON OUTPUT**

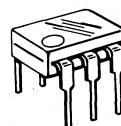

**CASE 730A-02
 PLASTIC**

SCHEMATIC

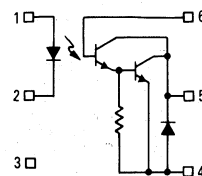

1. ANODE
2. CATHODE
3. NC
4. EMITTER
5. COLLECTOR
6. BASE

H11G1, H11G2, H11G3

ELECTRICAL CHARACTERISTICS (T_A = 25°C unless otherwise noted)

| Characteristic | Symbol | Min | Typ | Max | Unit |
|----------------|--------|-----|-----|-----|------|
|----------------|--------|-----|-----|-----|------|

INPUT LED

| | | | | | |
|--|----------------|---|------|-----|-------|
| Reverse Leakage Current (V _R = 3 V) | I _R | — | 0.05 | 10 | μA |
| Forward Voltage I _F = 10 mA) | V _F | — | 1.1 | 1.5 | Volts |
| Capacitance (V = 0 V, f = 1 MHz) | C _J | — | 18 | — | pF |

DARLINGTON OUTPUT (T_A = 25°C and I_F = 0 unless otherwise noted)

| | | | | | | |
|--|-------------------------|----------------------|-----------------|-------------|-------------|-------|
| Collector-Emitter Breakdown Voltage (I _C = 1 mA, I _F = 0) | H11G1 H11G2 H11G3 | V _{(BR)CEO} | 100 80 55 | — — — | — — — | Volts |
| Collector-Base Breakdown Voltage (I _C = 100 μA, I _F = 0) | H11G1 H11G2 H11G3 | V _{(BR)CBO} | 100 80 55 | — — — | — — — | Volts |
| Emitter-Base Breakdown Voltage (I _E = 100 μA, I _F = 0) | | V _{(BR)EBO} | 7 | — | — | Volts |
| Collector-Emitter Dark Current (V _{CE} = 80 V) | H11G1 | I _{CE} | — | — | 100 | nA |
| (V _{CE} = 80 V, T _A = 80°C) | H11G1 | | — | — | 100 | μA |
| (V _{CE} = 60 V) | H11G2 | | — | — | 100 | nA |
| (V _{CE} = 60 V, T _A = 80°C) | H11G2 | | — | — | 100 | μA |
| (V _{CE} = 30 V) | H11G3 | | — | — | 100 | nA |
| Capacitance (V _{CB} = 10 V, f = 1 MHz) | | C _{CB} | — | 6 | — | pF |

COUPLED (T_A = 25°C unless otherwise noted)

| | | | | | | |
|--|----------|----------------------|------|------------------|-----|-------|
| Collector Output Current (V _{CE} = 1 V, I _F = 10 mA) | H11G1, 2 | I _C | 100 | — | — | mA |
| (V _{CE} = 5 V, I _F = 1 mA) | H11G1, 2 | | 5 | — | — | |
| (V _{CE} = 5 V, I _F = 1 mA) | H11G3 | | 2 | — | — | |
| Collector-Emitter Saturation Voltage (I _F = 1 mA, I _C = 1 mA) | H11G1, 2 | V _{CE(sat)} | — | 0.75 | 1 | Volts |
| (I _F = 16 mA, I _C = 50 mA) | H11G1, 2 | | — | 0.85 | 1 | |
| (I _F = 20 mA, I _C = 50 mA) | H11G3 | | — | 0.85 | 1.2 | |
| Isolation Surge Voltage (1, 2) (60 Hz ac Peak, 1 Second) | | V _{ISO} | 7500 | — | — | Volts |
| Isolation Resistance (1) (V = 500 Vdc) | | | — | 10 ¹¹ | — | Ohms |
| Isolation Capacitance (1) (V = 0 V, f = 1 MHz) | | C _{IO} | — | 2 | — | pF |

SWITCHING (T_A = 25°C)

| | | | | | | |
|---------------|---|------------------|---|-----|---|----|
| Turn-On Time | (I _F = 10 mA, V _{CC} = 5 V, R _L = 100 Ω, Pulse Width ≤ 300 μs, f = 30 Hz) | t _{on} | — | 5 | — | μs |
| Turn-Off Time | | t _{off} | — | 100 | — | |

- (1) For this test LED Pins 1 and 2 are common and Photodarlington Pins 4 and 5 are common.
 (2) Isolation Surge Voltage, V_{ISO}, is an internal device dielectric breakdown rating.

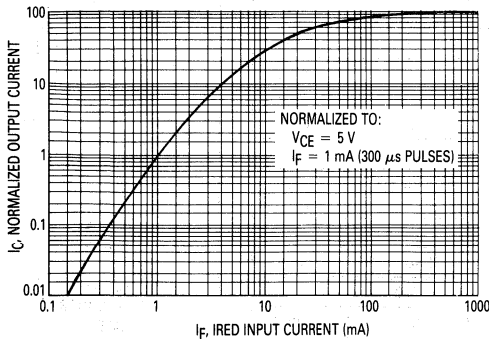

Figure 1. Output Current versus Input Current

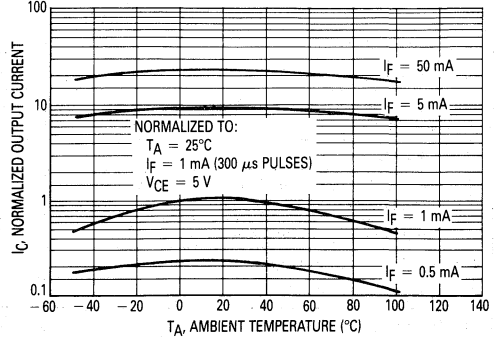

Figure 2. Output Current versus Temperature

H11G1, H11G2, H11G3

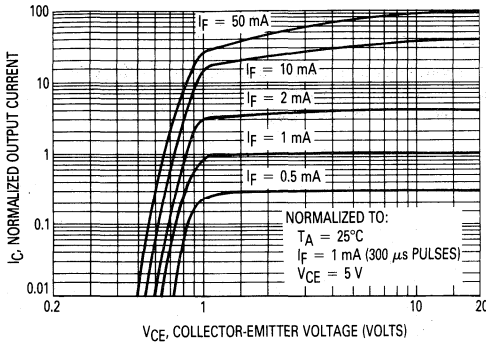

Figure 3. Output Current versus Collector-Emitter Voltage

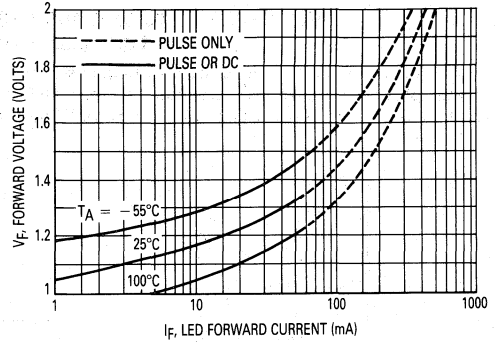

Figure 4. LED Forward Characteristics

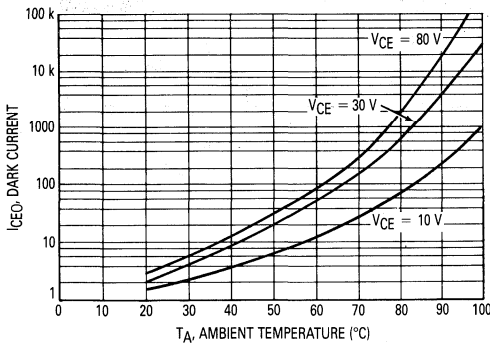

Figure 5. Collector-Emitter Dark Current versus Temperature

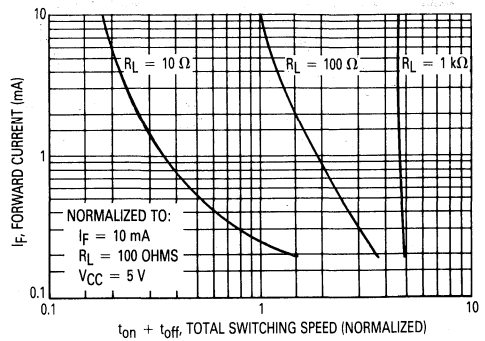
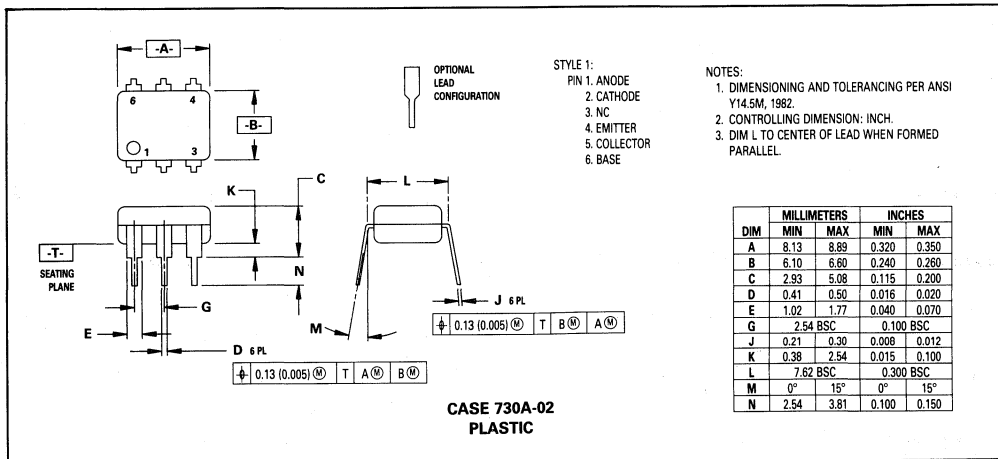

Figure 6. Input Current versus Total Switching Speed

OUTLINE DIMENSIONS



H11G1, H11G2, H11G3

INTERFACING TTL OR CMOS LOGIC TO 50-VOLT, 1000-OHMS RELAY FOR TELEPHONY APPLICATIONS

In order to interface positive logic to negative-powered electromechanical relays, a change in voltage level and polarity plus electrical isolation are required. The H11Gx can provide this interface and eliminate the external amplifiers and voltage divider networks previously required. The circuit below shows a typical approach for the interface.

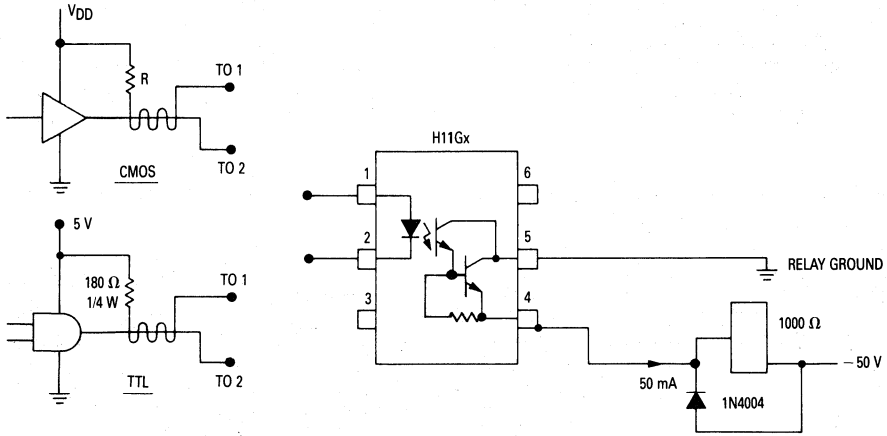

6

6-Pin DIP Optoisolators Logic Output

H11L1
H11L2

**6-PIN DIP
 OPTOISOLATORS
 LOGIC OUTPUT**

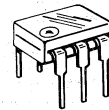

**CASE 730A-02
 PLASTIC**

... gallium arsenide IRED optically coupled to a high-speed integrated detector with Schmitt trigger output. Designed for applications requiring electrical isolation, fast response time, noise immunity and digital logic compatibility such as interfacing computer terminals to peripheral equipment, digital control of power supplies, motors and other servo machine applications.

- High Isolation Voltage — $V_{ISO} = 7500$ Vac pk Min
- Guaranteed Switching Times — $t_{ON}, t_{OFF} < 4 \mu s$
- Built-In ON/OFF Threshold Hysteresis
- Economical, Standard Dual-In-Line Plastic Package
- UL Recognized, File No. E54915

MAXIMUM RATINGS ($T_A = 25^\circ C$ unless otherwise noted)

| Rating | Symbol | Value | Unit |
|---|-----------|-------------|----------------------|
| INPUT LED | | | |
| Reverse Voltage | V_R | 6 | Volts |
| Forward Current — Continuous — Peak Pulse Width = 300 μs , 2% Duty Cycle | I_F | 60 1.2 | mA Amp |
| LED Power Dissipation @ $T_A = 25^\circ C$ Derate above $25^\circ C$ | P_D | 120 1.41 | mW mW/ $^\circ C$ |
| OUTPUT DETECTOR | | | |
| Output Voltage Range | V_O | 0–16 | Volts |
| Supply Voltage Range | V_{CC} | 3–16 | Volts |
| Output Current | I_O | 50 | mA |
| Detector Power Dissipation @ $T_A = 25^\circ C$ Derate above $25^\circ C$ | P_D | 150 1.76 | mW mW/ $^\circ C$ |
| TOTAL DEVICE | | | |
| Total Device Dissipation @ $T_A = 25^\circ C$ Derate above $25^\circ C$ | P_D | 250 2.94 | mW mW/ $^\circ C$ |
| Maximum Operating Temperature | T_A | –40 to +85 | $^\circ C$ |
| Storage Temperature Range | T_{stg} | –55 to +150 | $^\circ C$ |
| Soldering Temperature (10 s) | | 260 | $^\circ C$ |
| Isolation Surge Voltage (Pk ac Voltage, 60 Hz, 1 Second Duration) (1) | V_{ISO} | 7500 | Volts |

(1) Isolation surge voltage is an internal device dielectric breakdown rating.

H11L1, H11L2

ELECTRICAL CHARACTERISTICS (T_A = 0 to 70°C)

| Characteristic | Symbol | Min | Typ | Max | Unit |
|---|---|------------|-------------|-----------|---------|
| INPUT LED | | | | | |
| Reverse Leakage Current (V _R = 3 V, R _L = 1 MΩ) | I _R | — | 0.05 | 10 | μA |
| Forward Voltage (I _F = 10 mA) (I _F = 0.3 mA) | V _F | — 0.75 | 1.2 0.95 | 1.5 | Volts |
| Capacitance (V _R = 0 V, f = 1 MHz) | C | — | 18 | — | pF |
| OUTPUT DETECTOR | | | | | |
| Operating Voltage | V _{CC} | 3 | — | 15 | Volts |
| Supply Current (I _F = 0, V _{CC} = 5 V) | I _{CC(off)} | — | 1 | 5 | mA |
| Output Current, High (I _F = 0, V _{CC} = V _O = 15 V) | I _{OH} | — | — | 100 | μA |
| COUPLED | | | | | |
| Supply Current (I _F = I _{F(on)} , V _{CC} = 5 V) | I _{CC(on)} | — | 1.6 | 5 | mA |
| Output Voltage, Low (R _L = 270 Ω, V _{CC} = 5 V, I _F = I _{F(on)}) | V _{OL} | — | 0.2 | 0.4 | Volts |
| Threshold Current, ON (R _L = 270 Ω, V _{CC} = 5 V) | I _{F(on)} | — — | 1 — | 1.6 10 | mA |
| Threshold Current, OFF (R _L = 270 Ω, V _{CC} = 5 V) | I _{F(off)} | 0.3 0.3 | 0.75 — | — — | mA |
| Hysteresis Ratio (R _L = 270 Ω, V _{CC} = 5 V) | I _{F(off)} / I _{F(on)} | 0.5 | 0.75 | 0.9 | |
| Isolation Voltage (1) 60 Hz, AC Peak, 1 second, T _A = 25°C | V _{ISO} | 7500 | — | — | Vac(pk) |
| Turn-On Time | t _{on} | — | 1.2 | 4 | μs |
| Fall Time | t _f | — | 0.1 | — | |
| Turn-Off Time | t _{off} | — | 1.2 | 4 | |
| Rise Time | t _r | — | 0.1 | — | |

(1) For this test IRED Pins 1 and 2 are common and Output Gate Pins 4, 5, 6 are common.

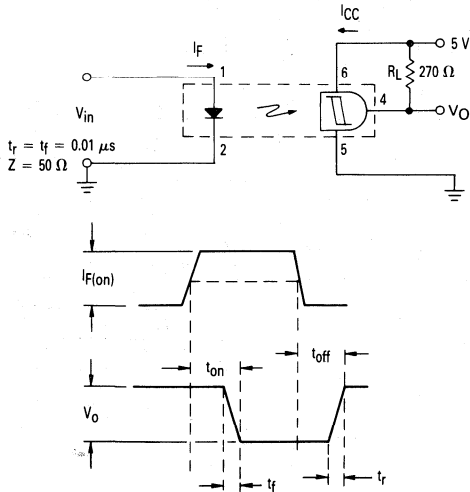
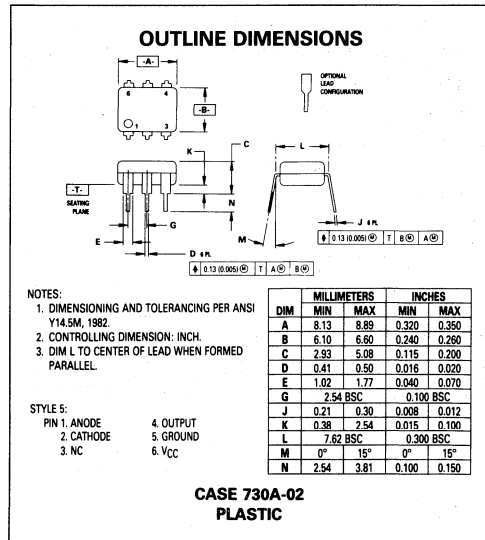

Figure 1. Switching Test Circuit



H11L1, H11L2

TYPICAL CHARACTERISTICS

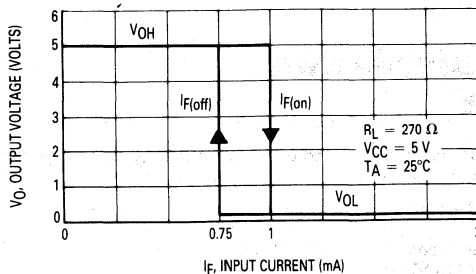

Figure 2. Transfer Characteristics for H11L1

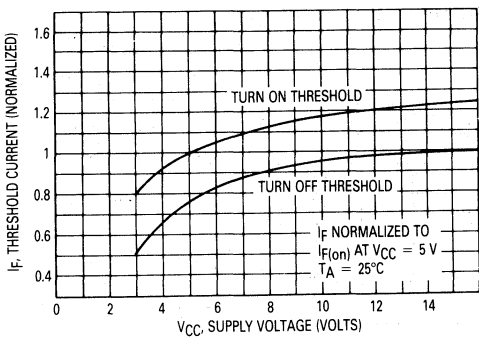

Figure 3. Threshold Current versus Supply Voltage

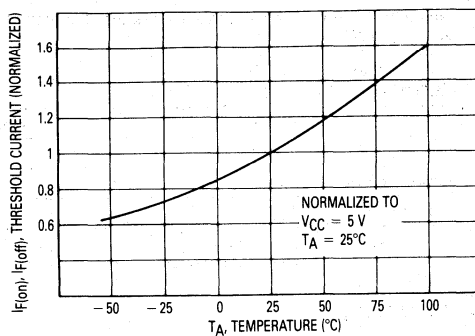

Figure 4. Threshold Current versus Temperature

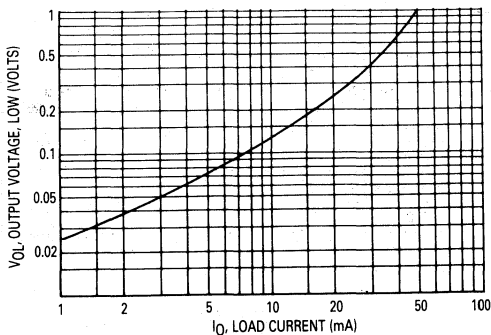

Figure 5. Output Voltage, Low versus Load Current

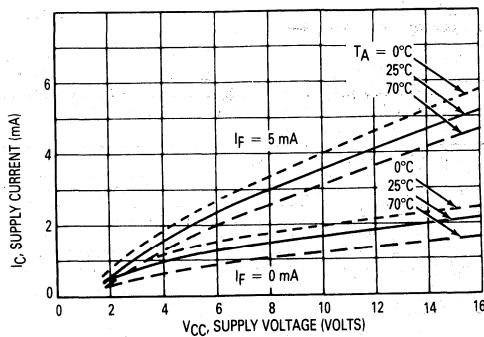



Figure 6. Supply Current versus Supply Voltage

6-Pin DIP Optoisolators Transistor Output

These devices consist of a gallium arsenide infrared emitting diode optically coupled to a monolithic silicon phototransistor detector.

- Convenient Plastic Dual-In-Line Package
- Economical
- High Input-Output Isolation Guaranteed — 7500 Volts Peak
- UL Recognized. File Number E54915 
- VDE approved per standard 0883/6.80 (Certificate number 41853), with additional approval to DIN IEC380/VDE0806, IEC435/VDE0805, IEC65/VDE0860, VDE110b, covering all other standards with equal or less stringent requirements, including IEC204/VDE0113, VDE0160, VDE0832, VDE0833, etc. 
- Special lead form available (add suffix "T" to part number) which satisfies VDE0883/6.80 requirement for 8 mm minimum creepage distance between input and output solder pads.
- Various lead form options available. Consult "Optoisolator Lead Form Options" data sheet for details.

MAXIMUM RATINGS ($T_A = 25^\circ\text{C}$ unless otherwise noted)

| Rating | Symbol | Value | Unit |
|--------|--------|-------|------|
|--------|--------|-------|------|

INPUT LED

| | | | |
|---|-------|-------------|-------------|
| Reverse Voltage | V_R | 3 | Volts |
| Forward Current — Continuous | I_F | 60 | mA |
| LED Power Dissipation @ $T_A = 25^\circ\text{C}$ with Negligible Power in Output Detector Derate above 25°C | P_D | 120 1.41 | mW mW/°C |

OUTPUT TRANSISTOR

| | | | |
|--|-----------|-------------|-------------|
| Collector-Emitter Voltage | V_{CEO} | 30 | Volts |
| Emitter-Collector Voltage | V_{ECO} | 7 | Volts |
| Collector-Base Voltage | V_{CBO} | 70 | Volts |
| Collector Current — Continuous | I_C | 150 | mA |
| Detector Power Dissipation @ $T_A = 25^\circ\text{C}$ with Negligible Power in Input LED Derate above 25°C | P_D | 150 1.76 | mW mW/°C |

TOTAL DEVICE

| | | | |
|--|-----------|-------------|-------------|
| Isolation Surge Voltage (1) (Peak ac Voltage, 60 Hz, 1 sec Duration) | V_{ISO} | 7500 | Vac |
| Total Device Power Dissipation @ $T_A = 25^\circ\text{C}$ Derate above 25°C | P_D | 250 2.94 | mW mW/°C |
| Ambient Operating Temperature Range | T_A | -55 to +100 | °C |
| Storage Temperature Range | T_{stg} | -55 to +150 | °C |
| Soldering Temperature (10 seconds, 1/16" from case) | T_{sol} | 260 | °C |

(1) Isolation surge voltage is an internal device dielectric breakdown rating. For this test, Pins 1 and 2 are common, and Pins 4, 5 and 6 are common.

MCT2
MCT2E

6-PIN DIP
OPTOISOLATORS
TRANSISTOR OUTPUT

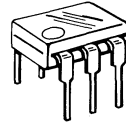

CASE 730A-02
PLASTIC

SCHEMATIC

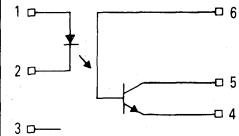

1. LED ANODE
2. LED CATHODE
3. N.C.
4. EMITTER
5. COLLECTOR
6. BASE

MCT2, MCT2E

ELECTRICAL CHARACTERISTICS ($T_A = 25^\circ\text{C}$ unless otherwise noted)

| Characteristic | Symbol | Min | Typ | Max | Unit |
|---|--------|---------------------------|------|------|---------------|
| INPUT LED | | | | | |
| Forward Voltage ($I_F = 20\text{ mA}$) | V_F | $T_A = 25^\circ\text{C}$ | — | 1.23 | Volts |
| | | $T_A = -55^\circ\text{C}$ | — | 1.35 | |
| | | $T_A = 100^\circ\text{C}$ | — | 1.15 | |
| Reverse Leakage Current ($V_R = 3\text{ V}$) | I_R | — | 0.01 | 10 | μA |
| Capacitance ($V = 0\text{ V}$, $f = 1\text{ MHz}$) | C_J | — | 18 | — | pF |

OUTPUT TRANSISTOR

| | | | | | | |
|--|---------------|---------------------------|-----|-----|-------|---------------|
| Collector-Emitter Dark Current ($V_{CE} = 10\text{ V}$) | I_{CEO} | $T_A = 25^\circ\text{C}$ | — | 1 | 50 | nA |
| | | $T_A = 100^\circ\text{C}$ | — | 1 | — | μA |
| Collector-Base Dark Current ($V_{CB} = 10\text{ V}$) | I_{CBO} | $T_A = 25^\circ\text{C}$ | — | 0.2 | 20 | nA |
| | | $T_A = 100^\circ\text{C}$ | — | 100 | — | |
| Collector-Emitter Breakdown Voltage ($I_C = 1\text{ mA}$) | $V_{(BR)CEO}$ | 30 | 45 | — | Volts | |
| Collector-Base Breakdown Voltage ($I_C = 10\text{ }\mu\text{A}$) | $V_{(BR)CB0}$ | 70 | 100 | — | Volts | |
| Emitter-Collector Breakdown Voltage ($I_E = 100\text{ }\mu\text{A}$) | $V_{(BR)ECO}$ | 7 | 7.8 | — | Volts | |
| DC Current Gain ($I_C = 5\text{ mA}$, $V_{CE} = 5\text{ V}$) | h_{FE} | — | 500 | — | — | |
| Collector-Emitter Capacitance ($f = 1\text{ MHz}$, $V_{CE} = 0\text{ V}$) | C_{CE} | — | 7 | — | pF | |
| Collector-Base Capacitance ($f = 1\text{ MHz}$, $V_{CB} = 0\text{ V}$) | C_{CB} | — | 19 | — | pF | |
| Emitter-Base Capacitance ($f = 1\text{ MHz}$, $V_{EB} = 0\text{ V}$) | C_{EB} | — | 9 | — | pF | |

COUPLED

| | | | | | |
|--|---------------|-----------|------|-----|---------------|
| Output Collector Current ($I_F = 10\text{ mA}$, $V_{CE} = 10\text{ V}$) | I_C | 2 | 7 | — | mA |
| Collector-Emitter Saturation Voltage ($I_C = 2\text{ mA}$, $I_F = 16\text{ mA}$) | $V_{CE(sat)}$ | — | 0.19 | 0.4 | Volts |
| Turn-On Time ($I_F = 10\text{ mA}$, $V_{CC} = 10\text{ V}$, $R_L = 100\text{ }\Omega$, Figure 11) | t_{on} | — | 2.8 | — | μs |
| Turn-Off Time ($I_F = 10\text{ mA}$, $V_{CC} = 10\text{ V}$, $R_L = 100\text{ }\Omega$, Figure 11) | t_{off} | — | 4.5 | — | μs |
| Rise Time ($I_F = 10\text{ mA}$, $V_{CC} = 10\text{ V}$, $R_L = 100\text{ }\Omega$, Figure 11) | t_r | — | 1.2 | — | μs |
| Fall Time ($I_F = 10\text{ mA}$, $V_{CC} = 10\text{ V}$, $R_L = 100\text{ }\Omega$, Figure 11) | t_f | — | 1.3 | — | μs |
| Isolation Voltage ($f = 60\text{ Hz}$, $t = 1\text{ sec}$) | V_{ISO} | 7500 | — | — | Vac(pk) |
| Isolation Resistance ($V = 500\text{ V}$) | R_{ISO} | 10^{11} | — | — | Ω |
| Isolation Capacitance ($V = 0\text{ V}$, $f = 1\text{ MHz}$) | C_{ISO} | — | 0.2 | — | pF |

6

TYPICAL CHARACTERISTICS

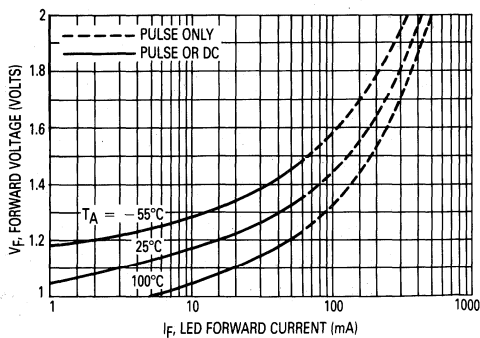

Figure 1. LED Forward Voltage versus Forward Current

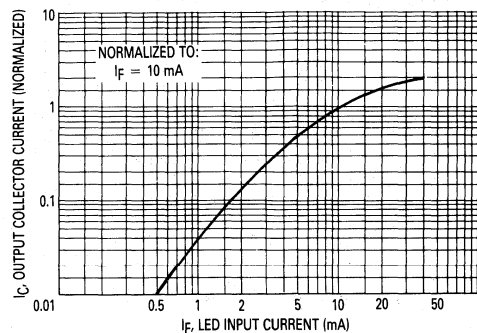

Figure 2. Output Current versus Input Current

MCT2, MCT2E

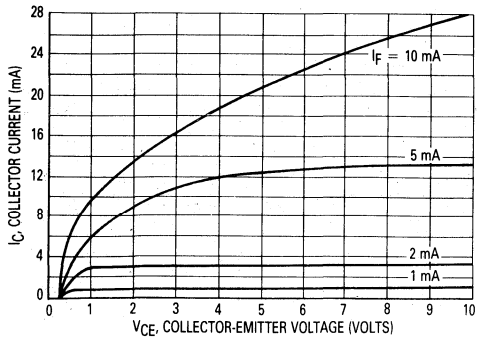

Figure 3. Collector Current versus Collector-Emitter Voltage

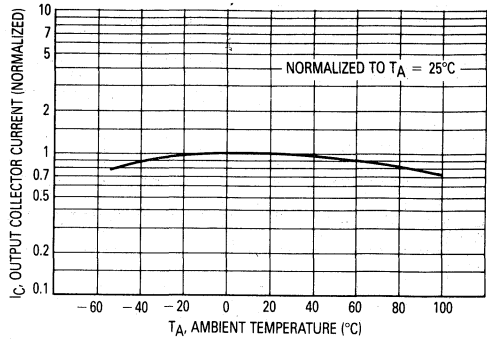

Figure 4. Output Current versus Ambient Temperature

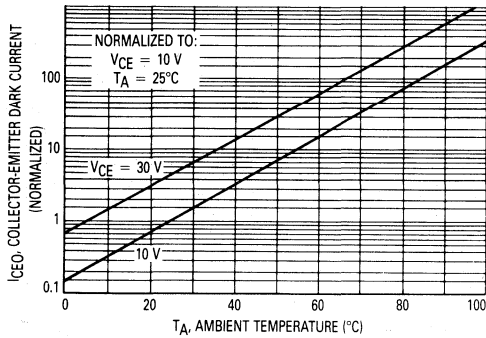

Figure 5. Dark Current versus Ambient Temperature

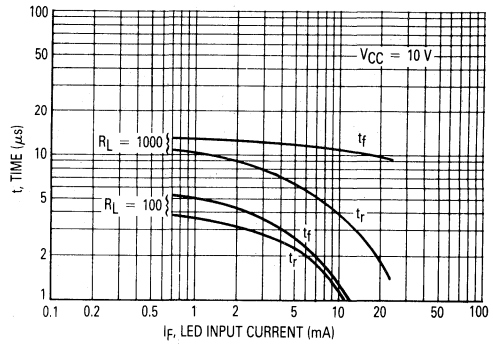

Figure 6. Rise and Fall Times

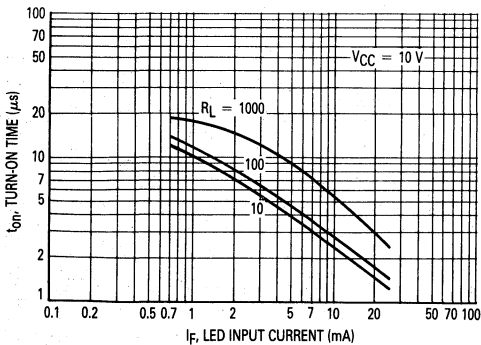

Figure 7. Turn-On Switching Times

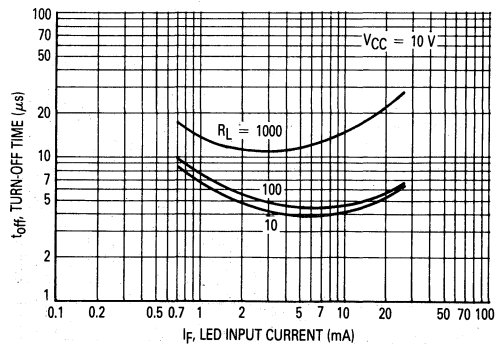

Figure 8. Turn-Off Switching Times

6

MCT2, MCT2E

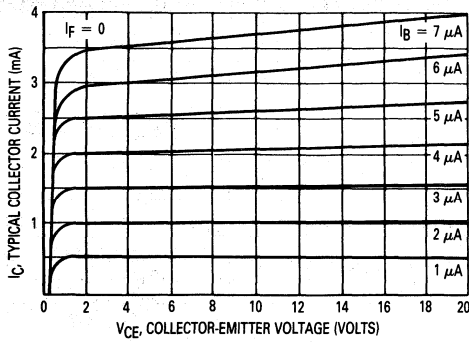

Figure 9. DC Current Gain (Detector Only)

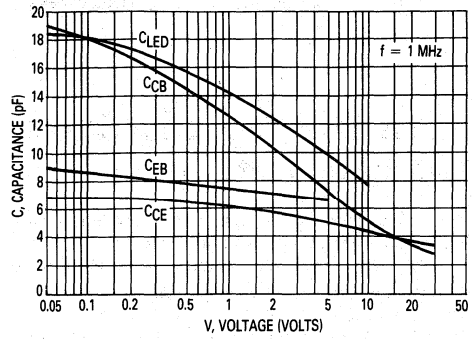

Figure 10. Capacitances versus Voltage

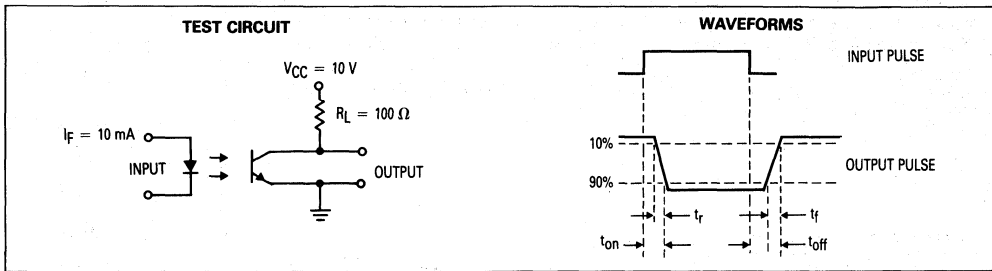
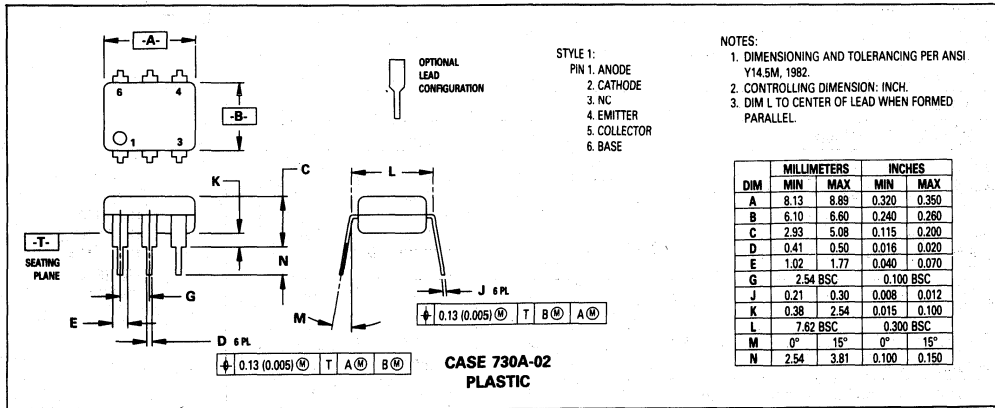

Figure 11. Switching Times



OUTLINE DIMENSIONS



6-Pin DIP Optoisolator Darlington Output

This device consists of a gallium arsenide infrared emitting diode optically coupled to a monolithic silicon photodarlington detector.

It is designed for use in applications requiring high sensitivity at low input currents.

- Convenient Plastic Dual-In-Line Package
- High Sensitivity to Low Input Drive Current
- High Input-Output Isolation Guaranteed — 7500 Volts Peak
- UL Recognized. File Number E54915 
- VDE approved per standard 0883/6.80 (Certificate number 41853), with additional approval to DIN IEC380/VDE0806, IEC435/VDE0805, IEC65/VDE0860, VDE0110b, covering all other standards with equal or less stringent requirements, including IEC204/VDE0113, VDE0160, VDE0832, VDE0833, etc. 
- Special lead form available (add suffix "T" to part number) which satisfies VDE0883/6.80 requirement for 8 mm minimum creepage distance between input and output solder pads.
- Various lead form options available. Consult "Optoisolator Lead Form Options" data sheet for details.

MOC119

**6-PIN DIP
 OPTOISOLATOR
 DARLINGTON
 OUTPUT**

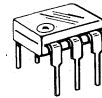

**CASE 730A-02
 PLASTIC**

MAXIMUM RATINGS ($T_A = 25^\circ\text{C}$ unless otherwise noted)

| Rating | Symbol | Value | Unit |
|--------|--------|-------|------|
|--------|--------|-------|------|

INPUT LED

| | | | |
|--|-------|------|----------------------|
| Reverse Voltage | V_R | 3 | Volts |
| Forward Current — Continuous | I_F | 60 | mA |
| LED Power Dissipation @ $T_A = 25^\circ\text{C}$ with Negligible Power in Output Detector | P_D | 120 | mW |
| Derate above 25°C | | 1.41 | mW/ $^\circ\text{C}$ |

OUTPUT DETECTOR

| | | | |
|---|-----------|------|----------------------|
| Collector-Emitter Voltage | V_{CEO} | 30 | Volts |
| Emitter-Collector Voltage | V_{ECO} | 7 | Volts |
| Detector Power Dissipation @ $T_A = 25^\circ\text{C}$ with Negligible Power in Input LED | P_D | 150 | mW |
| Derate above 25°C | | 1.76 | mW/ $^\circ\text{C}$ |

TOTAL DEVICE

| | | | |
|--|-----------|-------------|----------------------------|
| Isolation Surge Voltage (1) (Peak ac Voltage, 60 Hz, 1 sec Duration) | V_{ISO} | 7500 | Vac |
| Total Device Power Dissipation @ $T_A = 25^\circ\text{C}$ Derate above 25°C | P_D | 250 2.94 | mW mW/ $^\circ\text{C}$ |
| Ambient Operating Temperature Range | T_A | -55 to +100 | $^\circ\text{C}$ |
| Storage Temperature Range | T_{stg} | -55 to +150 | $^\circ\text{C}$ |
| Soldering Temperature (10 seconds, 1/16" from case) | — | 260 | $^\circ\text{C}$ |

(1) Isolation surge voltage is an internal device dielectric breakdown rating. For this test, Pins 1 and 2 are common, and Pins 4, 5 and 6 are common.

SCHEMATIC

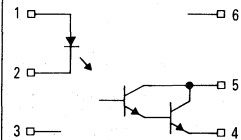

1. LED ANODE
2. LED CATHODE
3. N.C.
4. EMITTER
5. COLLECTOR
6. N.C.

MOC119

ELECTRICAL CHARACTERISTICS ($T_A = 25^\circ\text{C}$ unless otherwise noted)

| Characteristic | Symbol | Min | Typ | Max | Unit |
|--|--------|-----|------|-----|---------------|
| INPUT LED | | | | | |
| Reverse Leakage Current ($V_R = 3\text{ V}$) | I_R | — | 0.05 | 100 | μA |
| Forward Voltage ($I_F = 10\text{ mA}$) | V_F | — | 1.15 | 1.5 | Volts |
| Capacitance ($V_R = 0\text{ V}$, $f = 1\text{ MHz}$) | C | — | 18 | — | pF |

PHOTOTRANSISTOR ($T_A = 25^\circ\text{C}$ and $I_F = 0$ unless otherwise noted)

| | | | | | |
|---|---------------|----|---|-----|-------------|
| Collector-Emitter Dark Current ($V_{CE} = 10\text{ V}$) | I_{CEO} | — | — | 100 | nA |
| Collector-Emitter Breakdown Voltage ($I_C = 100\ \mu\text{A}$) | $V_{(BR)CEO}$ | 30 | — | — | Volts |
| Emitter-Collector Breakdown Voltage ($I_E = 10\ \mu\text{A}$) | $V_{(BR)ECO}$ | 7 | — | — | Volts |

COUPLED ($T_A = 25^\circ\text{C}$ unless otherwise noted)

| | | | | | |
|---|---------------|------|-----------|---|-------------|
| Collector Output Current (1) ($V_{CE} = 2\text{ V}$, $I_F = 10\text{ mA}$) | I_C | 30 | 45 | — | mA |
| Isolation Surge Voltage (2, 5), 60 Hz ac Peak, 1 Second | V_{ISO} | 7500 | — | — | Volts |
| Isolation Resistance (2) ($V = 500\text{ V}$) | R_{ISO} | — | 10^{11} | — | Ohms |
| Collector-Emitter Saturation Voltage (1) ($I_C = 10\text{ mA}$, $I_F = 10\text{ mA}$) | $V_{CE(sat)}$ | — | — | 1 | Volt |
| Isolation Capacitance (2) ($V = 0\text{ V}$, $f = 1\text{ MHz}$) | C_{ISO} | — | 0.2 | — | pF |

SWITCHING (Figures 4, 5)

| | | | | | | |
|---------------|--|-----------|---|-----|---|---------------|
| Turn-On Time | $V_{CE} = 10\text{ V}$, $R_L = 100\ \Omega$, $I_F = 5\text{ mA}$ | t_{on} | — | 3.5 | — | μs |
| Turn-Off Time | | t_{off} | — | 95 | — | |
| Rise Time | | t_r | — | 1 | — | |
| Fall Time | | t_f | — | 2 | — | |

- (1) Pulse Test: Pulse Width = $300\ \mu\text{s}$, Duty Cycle $\leq 2\%$.
 (2) For this test LED Pins 1 and 2 are common and Phototransistor Pins 4 and 5 are common.
 (3) Isolation Surge Voltage, V_{ISO} , is an internal device dielectric breakdown rating.

6

TYPICAL CHARACTERISTICS

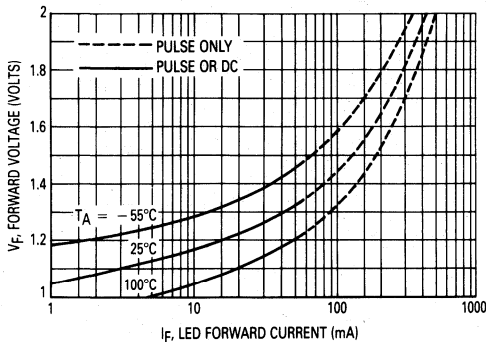

Figure 1. LED Forward Voltage versus Forward Current

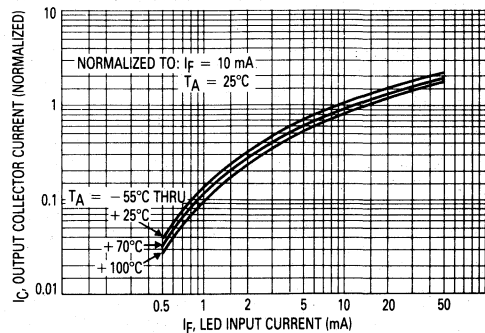

Figure 2. Output Current versus Input Current

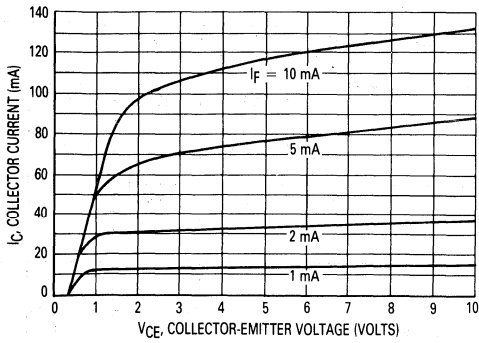

Figure 3. Collector Current versus Collector-Emitter Voltage

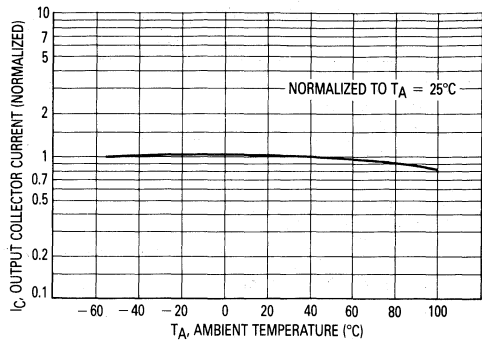

Figure 4. Output Current versus Ambient Temperature

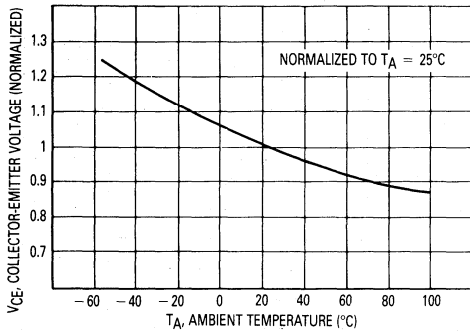

Figure 5. Collector-Emitter Voltage versus Ambient Temperature

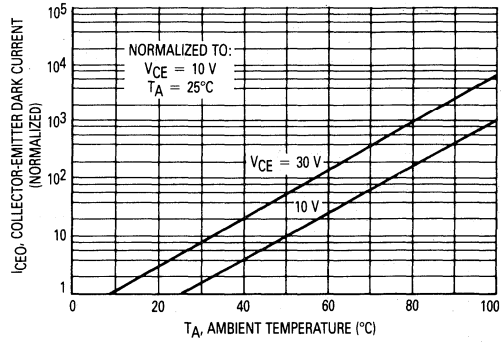

Figure 6. Collector-Emitter Dark Current versus Ambient Temperature

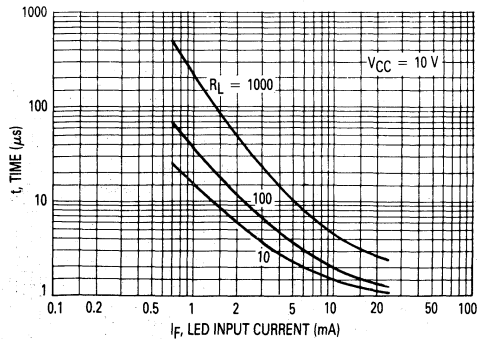

Figure 7. Turn-On Switching Times

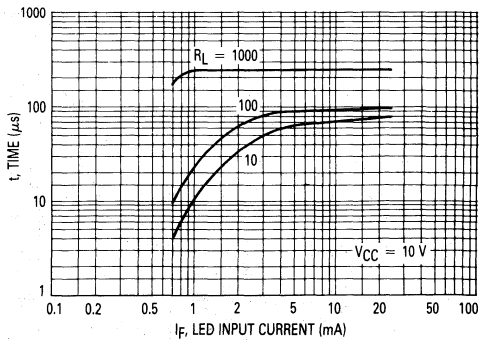

Figure 8. Turn-Off Switching Times

MOC119

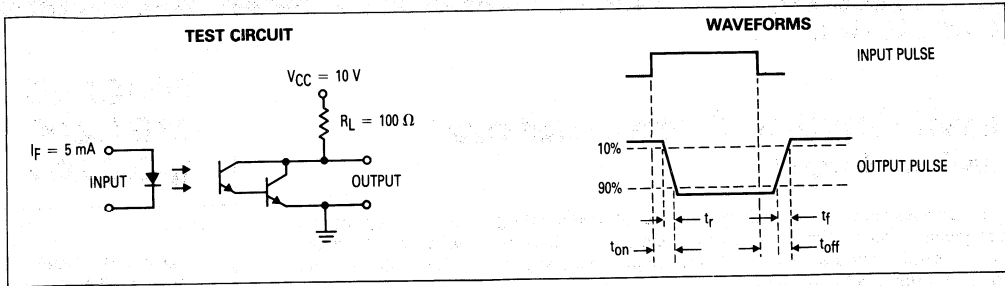
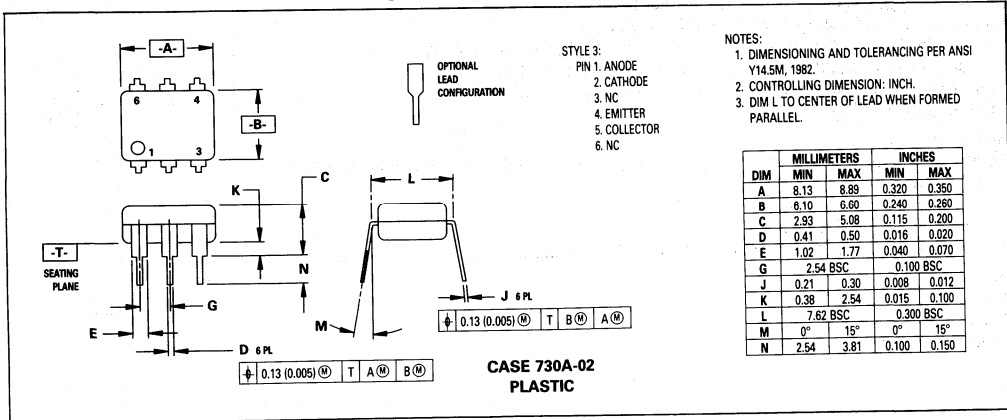



Figure 9. Switching Times

OUTLINE DIMENSIONS



Small Outline Optoisolators Transistor Output

These devices consist of a gallium arsenide infrared emitting diode optically coupled to a monolithic silicon phototransistor detector, in a surface mountable, small outline, plastic package. They are ideally suited for high density applications, and eliminate the need for through-the-board mounting.

- Convenient Plastic SOIC-8 Surface Mountable Package Style
- Closely Matched Current Transfer Ratios
- Minimum $V_{(BR)CEO}$ of 70 Volts Guaranteed
- Standard SOIC-8 Footprint, with .050" Lead Spacing
- Shipped in Tape and Reel, which Conforms to EIA Standard RS481A
- Compatible with Dual Wave, Vapor Phase and IR Reflow Soldering
- High Input-Output Isolation of 2500 Vac (rms) Guaranteed
- UL Recognized 

Ordering Information:

- To obtain MOC205, 206, 207 in Tape and Reel, add R1 or R2 suffix to device numbers as follows:
 R1-500 units on 7" reel
 R2-2500 units on 13" reel
- To obtain MOC205, 206, 207 in quantities of 75 (shipped in sleeves) — No Suffix

Marking Information:

- MOC205 = M205
- MOC206 = M206
- MOC207 = M207

MOC205
MOC206
MOC207

**SMALL OUTLINE
 OPTOISOLATORS
 TRANSISTOR OUTPUT**

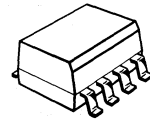

**CASE 846-01
 PLASTIC**

SCHEMATIC

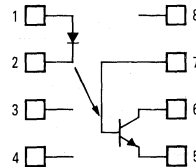

- 1: LED ANODE
- 2: LED CATHODE
- 3: NO CONNECTION
- 4: NO CONNECTION
- 5: EMITTER
- 6: COLLECTOR
- 7: BASE
- 8: NO CONNECTION

MAXIMUM RATINGS ($T_A = 25^\circ\text{C}$ unless otherwise noted)

| Rating | Symbol | Value | Unit |
|--|------------------|-------------|----------------------------|
| INPUT LED | | | |
| Forward Current — Continuous | I_F | 60 | mA |
| Forward Current — Peak ($PW = 100 \mu\text{s}, 120 \text{ pps}$) | $I_F(\text{pk})$ | 1.0 | A |
| Reverse Voltage | V_R | 6.0 | V |
| LED Power Dissipation @ $T_A = 25^\circ\text{C}$ Derate above 25°C | P_D | 90 0.8 | mW mW/ $^\circ\text{C}$ |
| OUTPUT TRANSISTOR | | | |
| Collector-Emitter Voltage | V_{CEO} | 70 | V |
| Collector-Base Voltage | V_{CBO} | 70 | V |
| Emitter-Collector Voltage | V_{ECO} | 7.0 | V |
| Collector Current — Continuous | I_C | 150 | mA |
| Detector Power Dissipation @ $T_A = 25^\circ\text{C}$ Derate above 25°C | P_D | 150 1.76 | mW mW/ $^\circ\text{C}$ |

(continued)

MOC205, MOC206, MOC207

MAXIMUM RATINGS — continued ($T_A = 25^\circ\text{C}$ unless otherwise noted)

| Rating | Symbol | Value | Unit |
|--|-----------|-------------|----------------------------|
| TOTAL DEVICE | | | |
| Input-Output Isolation Voltage (1) (60 Hz, 1.0 sec. duration) | V_{ISO} | 2500 | $V_{ac(rms)}$ |
| Total Device Power Dissipation @ $T_A = 25^\circ\text{C}$ Derate above 25°C | P_D | 150 2.94 | mW mW/ $^\circ\text{C}$ |
| Ambient Operating Temperature Range | T_A | -55 to +100 | $^\circ\text{C}$ |
| Storage Temperature Range | T_{stg} | -55 to +150 | $^\circ\text{C}$ |
| Lead Soldering Temperature (1/16" from case, 10 sec. duration) | — | 260 | $^\circ\text{C}$ |

ELECTRICAL CHARACTERISTICS ($T_A = 25^\circ\text{C}$ unless otherwise noted)

| Characteristic | Symbol | Min | Typ | Max | Unit |
|----------------|--------|-----|-----|-----|------|
|----------------|--------|-----|-----|-----|------|

INPUT LED

| | | | | | |
|--|-------|---|------|-----|---------------|
| Forward Voltage ($I_F = 10\text{ mA}$) | V_F | — | 1.15 | 1.5 | V |
| Reverse Leakage Current ($V_R = 6.0\text{ V}$) | I_R | — | 0.1 | 100 | μA |
| Capacitance | C | — | 18 | — | pF |

OUTPUT TRANSISTOR

| | | | | | | |
|--|---|------------|-----|-----|----|---------------|
| Collector-Emitter Dark Current | $(V_{CE} = 10\text{ V}, T_A = 25^\circ\text{C})$ | I_{CEO1} | — | 1.0 | 50 | nA |
| | $(V_{CE} = 10\text{ V}, T_A = 100^\circ\text{C})$ | I_{CEO2} | — | 1.0 | — | μA |
| Collector-Emitter Breakdown Voltage ($I_C = 100\ \mu\text{A}$) | $V_{(BR)CEO}$ | 70 | 120 | — | V | |
| Emitter-Collector Breakdown Voltage ($I_E = 100\ \mu\text{A}$) | $V_{(BR)ECO}$ | 7.0 | 7.8 | — | V | |
| Collector-Emitter Capacitance ($f = 1.0\text{ MHz}, V_{CE} = 0$) | C_{CE} | — | 7.0 | — | pF | |

COUPLED

| | | | | | | |
|--|---------------|-----------|------|-----|---------------|----|
| Output Collector Current ($I_F = 10\text{ mA}, V_{CE} = 10\text{ V}$) | MOC205 | I_C | 4.0 | 6.0 | 8.0 | mA |
| | MOC206 | | 6.3 | 9.4 | 12.5 | |
| | MOC207 | | 10 | 15 | 20 | |
| Collector-Emitter Saturation Voltage ($I_C = 2.0\text{ mA}, I_F = 10\text{ mA}$) | $V_{CE(sat)}$ | — | 0.15 | 0.4 | V | |
| Turn-On Time ($I_C = 2.0\text{ mA}, V_{CC} = 10\text{ V}, R_L = 100\ \Omega$) | t_{on} | — | 3.0 | — | μs | |
| Turn-Off Time ($I_C = 2.0\text{ mA}, V_{CC} = 10\text{ V}, R_L = 100\ \Omega$) | t_{off} | — | 2.8 | — | μs | |
| Rise Time ($I_C = 2.0\text{ mA}, V_{CC} = 10\text{ V}, R_L = 100\ \Omega$) | t_r | — | 1.6 | — | μs | |
| Fall Time ($I_C = 2.0\text{ mA}, V_{CC} = 10\text{ V}, R_L = 100\ \Omega$) | t_f | — | 2.2 | — | μs | |
| Isolation Voltage ($f = 60\text{ Hz}, t = 1.0\text{ sec.}$) | V_{ISO} | 2500 | — | — | $V_{ac(rms)}$ | |
| Isolation Resistance ($V_{I-O} = 500\text{ V}$) | R_{ISO} | 10^{11} | — | — | Ω | |
| Isolation Capacitance ($V_{I-O} = 0, f = 1.0\text{ MHz}$) | C_{ISO} | — | 0.2 | — | pF | |

(1) Input-Output Isolation Voltage, V_{ISO} , is an internal device dielectric breakdown rating. For this test, pins 1 and 2 are common, and pins 5, 6 and 7 are common.

TYPICAL CHARACTERISTICS

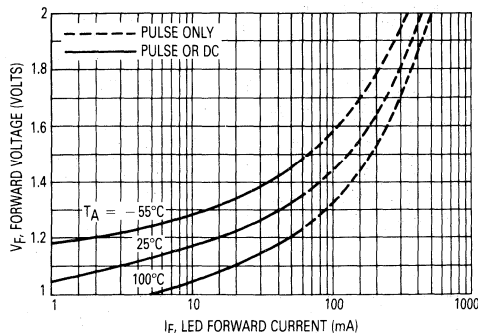

Figure 1. LED Forward Voltage versus Forward Current

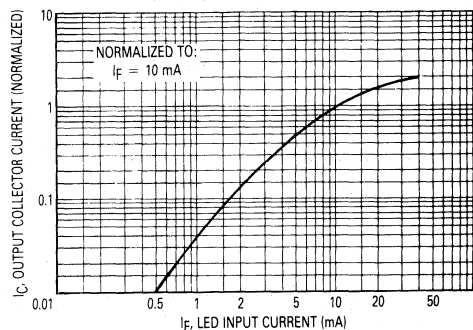

Figure 2. Output Current versus Input Current

MOC205, MOC206, MOC207

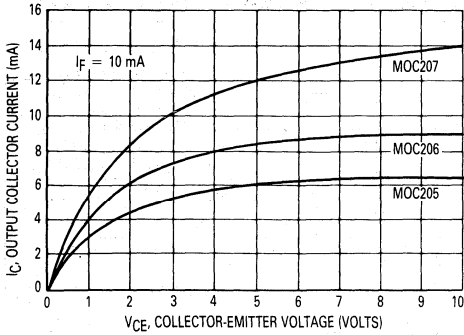

Figure 3. Output Current versus Collector-Emitter Voltage

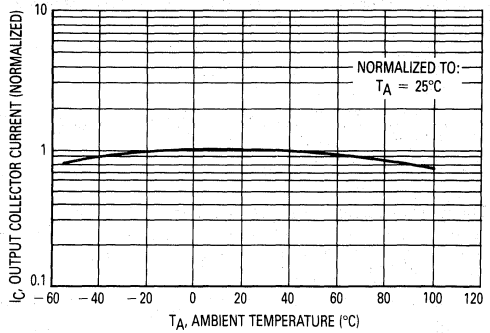

Figure 4. Output Current versus Ambient Temperature

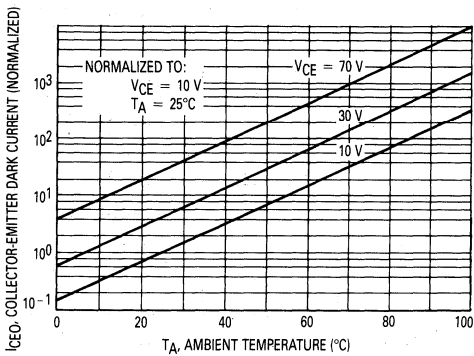

Figure 5. Dark Current versus Ambient Temperature

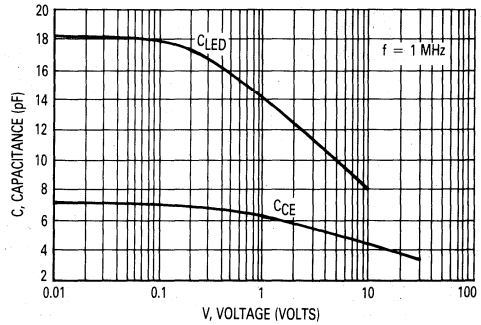
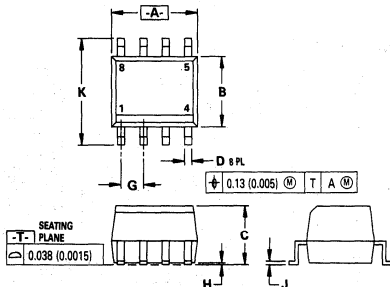

Figure 6. Capacitance versus Voltage

6

OUTLINE DIMENSIONS

CASE 846-01



- NOTES:
1. DIMENSIONING AND TOLERANCING PER ANSI Y14.5M, 1982.
 2. CONTROLLING DIMENSION: INCH.

| DIM | MILLIMETERS | | INCHES | |
|-----|-------------|------|-----------|-------|
| | MIN | MAX | MIN | MAX |
| A | 4.63 | 5.13 | 0.182 | 0.202 |
| B | 3.66 | 4.16 | 0.144 | 0.164 |
| C | 3.13 | 3.63 | 0.123 | 0.143 |
| D | 0.28 | 0.53 | 0.011 | 0.021 |
| G | 1.27 BSC | | 0.050 BSC | |
| H | 0.08 | 0.20 | 0.003 | 0.008 |
| J | 0.16 | 0.25 | 0.006 | 0.010 |
| K | 5.69 | 6.19 | 0.224 | 0.244 |

- STYLE 1:
1. ANODE
 2. CATHODE
 3. NC
 4. NC
 5. EMITTER
 6. COLLECTOR
 7. BASE
 8. NC

Small Outline Optoisolators

Transistor Output

These devices consist of a gallium arsenide infrared emitting diode optically coupled to a monolithic silicon phototransistor detector, in a surface mountable, small outline, plastic package. They are ideally suited for high density applications, and eliminate the need for through-the-board mounting.

- Convenient Plastic SOIC-8 Surface Mountable Package Style
- Standard SOIC-8 Footprint, with .050" Lead Spacing
- Shipped in Tape and Reel, which Conforms to EIA Standard RS481A
- Compatible with Dual Wave, Vapor Phase and IR Reflow Soldering
- High Input-Output Isolation of 2500 Vac (rms) Guaranteed
- UL Recognized 

Ordering Information:

- To obtain MOC211, 212, 213 in Tape and Reel, add R1 or R2 suffix to device numbers as follows:
R1-500 units on 7" reel
R2-2500 units on 13" reel
- To obtain MOC211, 212, 213 in quantities of 75 (shipped in sleeves) — No Suffix

Marking Information:

- MOC211 = M211
- MOC212 = M212
- MOC213 = M213

MAXIMUM RATINGS (T_A = 25°C unless otherwise noted)

| Rating | Symbol | Value | Unit |
|---|--------------------|-------------|-------------|
| INPUT LED | | | |
| Forward Current — Continuous | I _F | 60 | mA |
| Forward Current — Peak (PW = 100 μs, 120 pps) | I _{F(pk)} | 1.0 | A |
| Reverse Voltage | V _R | 6.0 | V |
| LED Power Dissipation @ T _A = 25°C Derate above 25°C | P _D | 90 0.8 | mW mW/°C |
| OUTPUT TRANSISTOR | | | |
| Collector-Emitter Voltage | V _{CEO} | 30 | V |
| Collector-Base Voltage | V _{CBO} | 70 | V |
| Emitter-Collector Voltage | V _{ECO} | 7.0 | V |
| Collector Current — Continuous | I _C | 150 | mA |
| Detector Power Dissipation @ T _A = 25°C Derate above 25°C | P _D | 150 1.76 | mW mW/°C |

(continued)

MOC211
MOC212
MOC213

**SMALL OUTLINE
OPTOISOLATORS
TRANSISTOR OUTPUT**

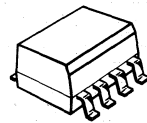

**CASE 846-01
PLASTIC**

SCHEMATIC

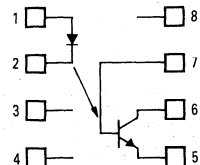

- 1: LED ANODE
- 2: LED CATHODE
- 3: NO CONNECTION
- 4: NO CONNECTION
- 5: EMITTER
- 6: COLLECTOR
- 7: BASE
- 8: NO CONNECTION

MOC211, MOC212, MOC213

MAXIMUM RATINGS — continued ($T_A = 25^\circ\text{C}$ unless otherwise noted)

| Rating | Symbol | Value | Unit |
|--|-----------|-------------|----------------------------|
| TOTAL DEVICE | | | |
| Input-Output Isolation Voltage (1) (60 Hz, 1.0 sec. duration) | V_{ISO} | 2500 | Vac(rms) |
| Total Device Power Dissipation @ $T_A = 25^\circ\text{C}$ Derate above 25°C | P_D | 150 2.94 | mW mW/ $^\circ\text{C}$ |
| Ambient Operating Temperature Range | T_A | -55 to +100 | $^\circ\text{C}$ |
| Storage Temperature Range | T_{stg} | -55 to +150 | $^\circ\text{C}$ |
| Lead Soldering Temperature (1/16" from case, 10 sec. duration) | — | 260 | $^\circ\text{C}$ |

ELECTRICAL CHARACTERISTICS ($T_A = 25^\circ\text{C}$ unless otherwise noted)

| Characteristic | Symbol | Min | Typ | Max | Unit |
|--|--------|-----|------|-----|---------------|
| INPUT LED | | | | | |
| Forward Voltage ($I_F = 10\text{ mA}$) | V_F | — | 1.15 | 1.5 | V |
| Reverse Leakage Current ($V_R = 6.0\text{ V}$) | I_R | — | 0.1 | 100 | μA |
| Capacitance | C | — | 18 | — | pF |

OUTPUT TRANSISTOR

| | | | | | |
|---|--|-----|-----|----|---------------|
| Collector-Emitter Dark Current ($V_{CE} = 10\text{ V}$, $T_A = 25^\circ\text{C}$) | I_{CEO1} | — | 1.0 | 50 | nA |
| | ($V_{CE} = 10\text{ V}$, $T_A = 100^\circ\text{C}$) I_{CEO2} | — | 1.0 | — | μA |
| Collector-Emitter Breakdown Voltage ($I_C = 100\ \mu\text{A}$) | $V_{(BR)CEO}$ | 30 | 90 | — | V |
| Emitter-Collector Breakdown Voltage ($I_E = 100\ \mu\text{A}$) | $V_{(BR)ECO}$ | 7.0 | 7.8 | — | V |
| Collector-Emitter Capacitance ($f = 1.0\text{ MHz}$, $V_{CE} = 0$) | C_{CE} | — | 7.0 | — | pF |

COUPLED

| | | | | | | |
|--|--------|---------------|-----------|------|-----|---------------|
| Output Collector Current ($I_F = 10\text{ mA}$, $V_{CE} = 10\text{ V}$) | MOC211 | I_C | 2.0 | 6.5 | — | mA |
| | MOC212 | | 5.0 | 9.0 | — | |
| | MOC213 | | 10 | 14 | — | |
| | | | | | | |
| Collector-Emitter Saturation Voltage ($I_C = 2.0\text{ mA}$, $I_F = 10\text{ mA}$) | | $V_{CE(sat)}$ | — | 0.15 | 0.4 | V |
| Turn-On Time ($I_C = 2.0\text{ mA}$, $V_{CC} = 10\text{ V}$, $R_L = 100\ \Omega$) | | t_{on} | — | 7.5 | — | μs |
| Turn-Off Time ($I_C = 2.0\text{ mA}$, $V_{CC} = 10\text{ V}$, $R_L = 100\ \Omega$) | | t_{off} | — | 5.7 | — | μs |
| Rise Time ($I_C = 2.0\text{ mA}$, $V_{CC} = 10\text{ V}$, $R_L = 100\ \Omega$) | | t_r | — | 3.2 | — | μs |
| Fall Time ($I_C = 2.0\text{ mA}$, $V_{CC} = 10\text{ V}$, $R_L = 100\ \Omega$) | | t_f | — | 4.7 | — | μs |
| Isolation Voltage ($f = 60\text{ Hz}$, $t = 1.0\text{ sec.}$) | | V_{ISO} | 2500 | — | — | Vac(rms) |
| Isolation Resistance ($V_{I-O} = 500\text{ V}$) | | R_{ISO} | 10^{11} | — | — | Ω |
| Isolation Capacitance ($V_{I-O} = 0$, $f = 1.0\text{ MHz}$) | | C_{ISO} | — | 0.2 | — | pF |

(1) Input-Output Isolation Voltage, V_{ISO} , is an internal device dielectric breakdown rating. For this test, pins 1 and 2 are common, and pins 5, 6 and 7 are common.

TYPICAL CHARACTERISTICS

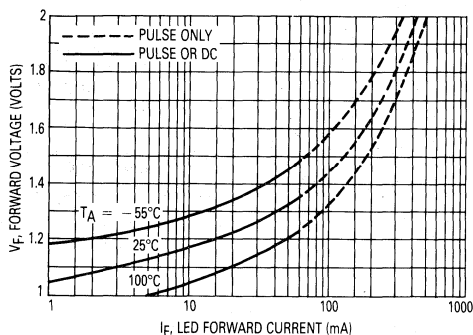

Figure 1. LED Forward Voltage versus Forward Current

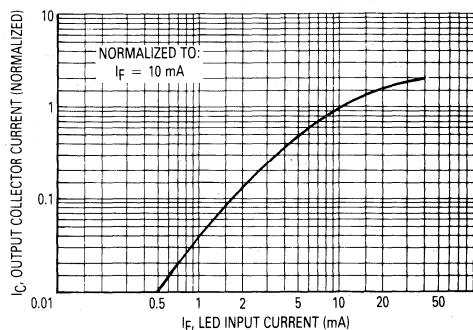

Figure 2. Output Current versus Input Current

MOC211, MOC212, MOC213

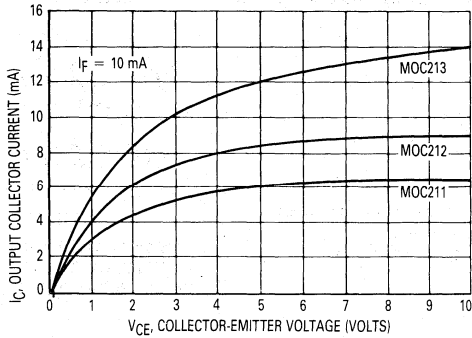

Figure 3. Output Current versus Collector-Emitter Voltage

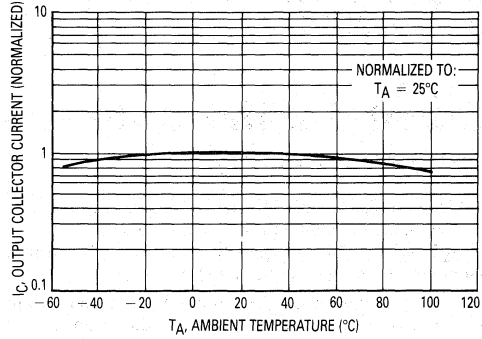

Figure 4. Output Current versus Ambient Temperature

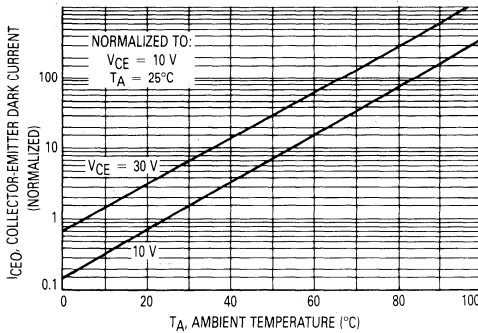

Figure 5. Dark Current versus Ambient Temperature

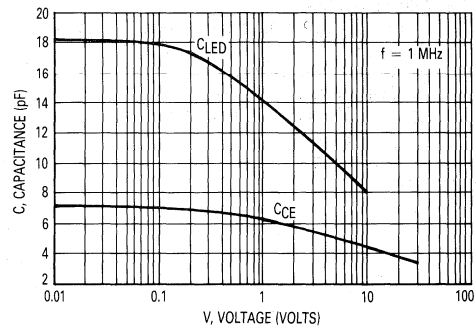
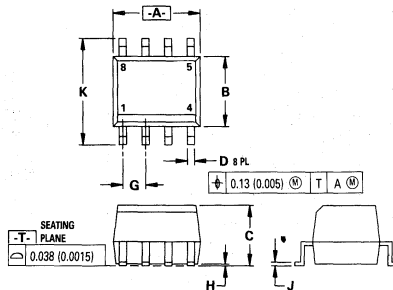

Figure 6. Capacitance versus Voltage

OUTLINE DIMENSIONS

CASE 846-01



NOTES:

1. DIMENSIONING AND TOLERANCING PER ANSI Y14.5M, 1982.
2. CONTROLLING DIMENSION: INCH.

| DIM | MILLIMETERS | | INCHES | |
|-----|-------------|------|--------|-------|
| | MIN | MAX | MIN | MAX |
| A | 4.63 | 5.13 | 0.182 | 0.202 |
| B | 3.66 | 4.16 | 0.144 | 0.164 |
| C | 3.13 | 3.63 | 0.123 | 0.143 |
| D | 0.28 | 0.53 | 0.011 | 0.021 |
| G | 1.27 | BSC | 0.050 | BSC |
| H | 0.08 | 0.20 | 0.003 | 0.008 |
| J | 0.16 | 0.25 | 0.006 | 0.010 |
| K | 5.69 | 6.19 | 0.224 | 0.244 |

STYLE 1:

- PIN 1. ANODE
- CATHODE
- NC
- NC
- EMITTER
- COLLECTOR
- BASE
- NC

Small Outline Optoisolators Transistor Output

These devices consist of a gallium arsenide infrared emitting diode optically coupled to a monolithic silicon phototransistor detector, in a surface mountable, small outline, plastic package. They are ideally suited for high density applications, and eliminate the need for through-the-board mounting.

- Convenient Plastic SOIC-8 Surface Mountable Package Style
- Low LED Input Current Required, for Easier Logic Interfacing
- Standard SOIC-8 Footprint, with .050" Lead Spacing
- Shipped in Tape and Reel, which Conforms to EIA Standard RS481A
- Compatible with Dual Wave, Vapor Phase and IR Reflow Soldering
- High Input-Output Isolation of 2500 Vac (rms) Guaranteed
- UL Recognized 

Ordering Information:

- To obtain MOC215, 216, 217 in Tape and Reel, add R1 or R2 suffix to device numbers as follows:
 R1-500 units on 7" reel
 R2-2500 units on 13" reel
- To obtain MOC215, 216, 217 in quantities of 75 (shipped in sleeves) — No Suffix

Marking Information:

- MOC215 = M215
- MOC216 = M216
- MOC217 = M217

MAXIMUM RATINGS ($T_A = 25^\circ\text{C}$ unless otherwise noted)

| Rating | Symbol | Value | Unit |
|--|------------------|-------------|----------------------------|
| INPUT LED | | | |
| Forward Current — Continuous | I_F | 60 | mA |
| Forward Current — Peak (PW = 100 μs , 120 pps) | $I_F(\text{pk})$ | 1.0 | A |
| Reverse Voltage | V_R | 6.0 | V |
| LED Power Dissipation @ $T_A = 25^\circ\text{C}$ Derate above 25°C | P_D | 90 0.8 | mW mW/ $^\circ\text{C}$ |
| OUTPUT TRANSISTOR | | | |
| Collector-Emitter Voltage | V_{CEO} | 30 | V |
| Collector-Base Voltage | V_{CBO} | 70 | V |
| Emitter-Collector Voltage | V_{ECO} | 7.0 | V |
| Collector Current — Continuous | I_C | 150 | mA |
| Detector Power Dissipation @ $T_A = 25^\circ\text{C}$ Derate above 25°C | P_D | 150 1.76 | mW mW/ $^\circ\text{C}$ |

(continued)

MOC215
MOC216
MOC217

**SMALL OUTLINE
 OPTOISOLATORS
 TRANSISTOR OUTPUT**

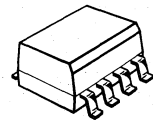

**CASE 846-01
 PLASTIC**

SCHEMATIC

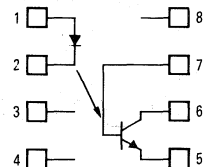

- 1: LED ANODE
- 2: LED CATHODE
- 3: NO CONNECTION
- 4: NO CONNECTION
- 5: EMITTER
- 6: COLLECTOR
- 7: BASE
- 8: NO CONNECTION

MOC215, MOC216, MOC217

MAXIMUM RATINGS — continued ($T_A = 25^\circ\text{C}$ unless otherwise noted)

| Rating | Symbol | Value | Unit |
|--|-----------|-------------|----------------------------|
| TOTAL DEVICE | | | |
| Input-Output Isolation Voltage (1) (60 Hz, 1.0 sec. duration) | V_{ISO} | 2500 | Vac(rms) |
| Total Device Power Dissipation @ $T_A = 25^\circ\text{C}$ Derate above 25°C | P_D | 150 2.94 | mW mW/ $^\circ\text{C}$ |
| Ambient Operating Temperature Range | T_A | -55 to +100 | $^\circ\text{C}$ |
| Storage Temperature Range | T_{stg} | -55 to +150 | $^\circ\text{C}$ |
| Lead Soldering Temperature (1/16" from case, 10 sec. duration) | — | 260 | $^\circ\text{C}$ |

ELECTRICAL CHARACTERISTICS ($T_A = 25^\circ\text{C}$ unless otherwise noted)

| Characteristic | Symbol | Min | Typ | Max | Unit |
|--|---------------|-----|------|-----|---------------|
| INPUT LED | | | | | |
| Forward Voltage ($I_F = 1.0\text{ mA}$) | V_F | — | 1.05 | 1.3 | V |
| Reverse Leakage Current ($V_R = 6.0\text{ V}$) | I_R | — | 0.1 | 100 | μA |
| Capacitance | C | — | 18 | — | pF |
| OUTPUT TRANSISTOR | | | | | |
| Collector-Emitter Dark Current ($V_{CE} = 5.0\text{ V}, T_A = 25^\circ\text{C}$) | I_{CEO1} | — | 1.0 | 50 | nA |
| ($V_{CE} = 5.0\text{ V}, T_A = 100^\circ\text{C}$) | I_{CEO2} | — | 1.0 | — | μA |
| Collector-Emitter Breakdown Voltage ($I_C = 100\ \mu\text{A}$) | $V_{(BR)CEO}$ | 30 | 90 | — | V |
| Emitter-Collector Breakdown Voltage ($I_E = 100\ \mu\text{A}$) | $V_{(BR)ECO}$ | 7.0 | 7.8 | — | V |
| Collector-Emitter Capacitance ($f = 1.0\text{ MHz}, V_{CE} = 0$) | C_{CE} | — | 7.0 | — | pF |

COUPLED

| | | | | | | |
|--|----------------------------|---------------|-------------------|-------------------|-------------|--------------------------------------|
| Output Collector Current ($I_F = 1.0\text{ mA}, V_{CE} = 5.0\text{ V}$) | MOC215 MOC216 MOC217 | I_C | 200 500 1.0 | 500 800 1.3 | — — — | μA μA mA |
| Collector-Emitter Saturation Voltage ($I_C = 100\ \mu\text{A}, I_F = 1.0\text{ mA}$) | | $V_{CE(sat)}$ | — | 0.35 | 0.4 | V |
| Turn-On Time ($I_C = 2.0\text{ mA}, V_{CC} = 10\text{ V}, R_L = 100\ \Omega$) | | t_{on} | — | 7.5 | — | μs |
| Turn-Off Time ($I_C = 2.0\text{ mA}, V_{CC} = 10\text{ V}, R_L = 100\ \Omega$) | | t_{off} | — | 5.7 | — | μs |
| Rise Time ($I_C = 2.0\text{ mA}, V_{CC} = 10\text{ V}, R_L = 100\ \Omega$) | | t_r | — | 3.2 | — | μs |
| Fall Time ($I_C = 2.0\text{ mA}, V_{CC} = 10\text{ V}, R_L = 100\ \Omega$) | | t_f | — | 4.7 | — | μs |
| Isolation Voltage ($f = 60\text{ Hz}, t = 1.0\text{ sec.}$) | | V_{ISO} | 2500 | — | — | Vac(rms) |
| Isolation Resistance ($V_{I-O} = 500\text{ V}$) | | R_{ISO} | 10^{11} | — | — | Ω |
| Isolation Capacitance ($V_{I-O} = 0, f = 1.0\text{ MHz}$) | | C_{ISO} | — | 0.2 | — | pF |

(1) Input-Output Isolation Voltage, V_{ISO} , is an internal device dielectric breakdown rating. For this test, pins 1 and 2 are common, and pins 5, 6 and 7 are common.

TYPICAL CHARACTERISTICS

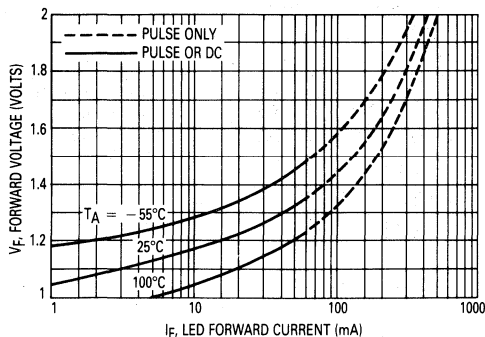

Figure 1. LED Forward Voltage versus Forward Current

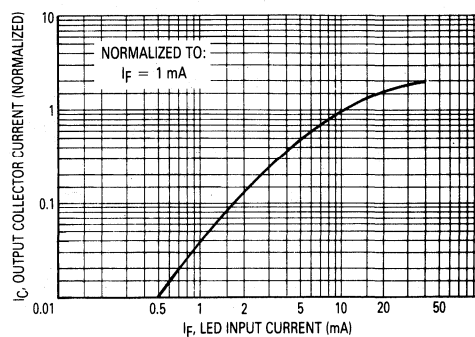

Figure 2. Output Current versus Input Current

MOC215, MOC216, MOC217

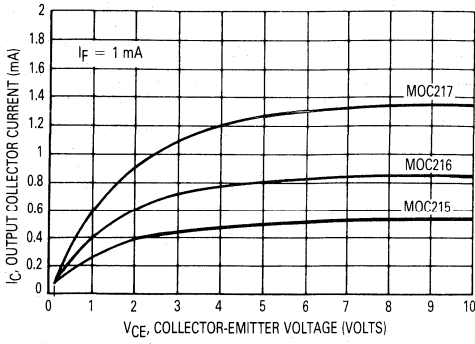

Figure 3. Output Current versus Collector-Emitter Voltage

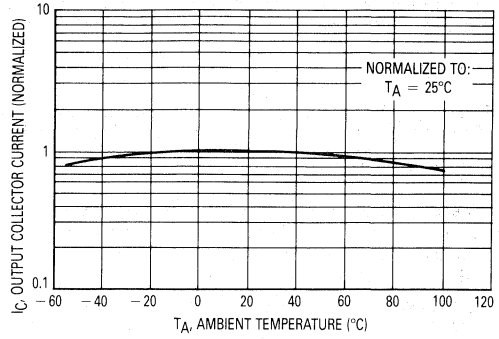

Figure 4. Output Current versus Ambient Temperature

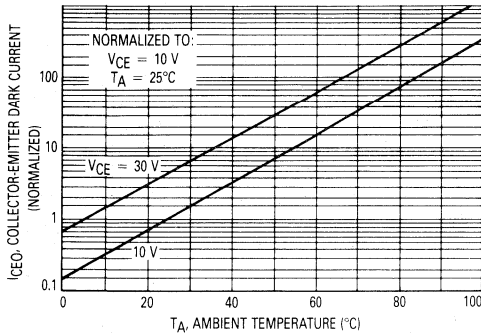

Figure 5. Dark Current versus Ambient Temperature

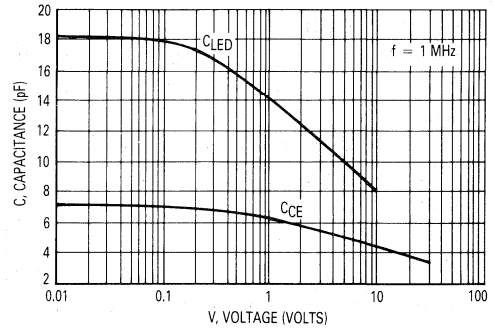
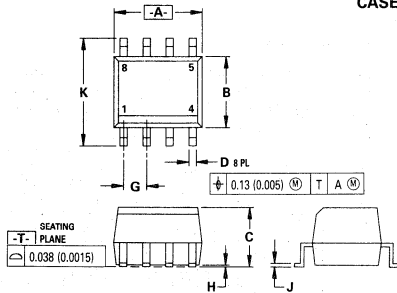

Figure 6. Capacitance versus Voltage

6

OUTLINE DIMENSIONS

CASE 846-01



NOTES:

1. DIMENSIONING AND TOLERANCING PER ANSI Y14.5M, 1982.
2. CONTROLLING DIMENSION: INCH.

| DIM | MILLIMETERS | | INCHES | |
|-----|-------------|------|-----------|-------|
| | MIN | MAX | MIN | MAX |
| A | 4.63 | 5.13 | 0.182 | 0.202 |
| B | 3.66 | 4.16 | 0.144 | 0.164 |
| C | 3.13 | 3.63 | 0.123 | 0.143 |
| D | 0.28 | 0.53 | 0.011 | 0.021 |
| G | 1.27 BSC | | 0.050 BSC | |
| H | 0.08 | 0.20 | 0.003 | 0.008 |
| J | 0.16 | 0.25 | 0.006 | 0.010 |
| K | 5.69 | 6.19 | 0.224 | 0.244 |

STYLE 1:

1. ANODE
2. CATHODE
3. NC
4. NC
5. EMITTER
6. COLLECTOR
7. BASE
8. NC

Small Outline Optoisolators Darlington Output

These devices consist of a gallium arsenide infrared emitting diode optically coupled to a monolithic silicon photodarlington detector, in a surface mountable, small outline, plastic package. They are ideally suited for high density applications, and eliminate the need for through-the-board mounting.

- Convenient Plastic SOIC-8 Surface Mountable Package Style
- High Current Transfer Ratio (CTR) at Low LED Input Current, for Easier Logic Interfacing
- Standard SOIC-8 Footprint, with .050" Lead Spacing
- Shipped in Tape and Reel, which Conforms to EIA Standard RS481A
- Compatible with Dual Wave, Vapor Phase and IR Reflow Soldering
- High Input-Output Isolation of 2500 Vac (rms) Guaranteed
- UL Recognized 

Ordering Information:

- To obtain MOC221, 222, 223 in Tape and Reel, add R1 or R2 suffix to device numbers as follows:
R1-500 units on 7" reel
R2-2500 units on 13" reel
- To obtain MOC221, 222, 223 in quantities of 75 (shipped in sleeves) — No Suffix

Marking Information:

- MOC221 = M221
- MOC222 = M222
- MOC223 = M223

MAXIMUM RATINGS (T_A = 25°C unless otherwise noted)

| Rating | Symbol | Value | Unit |
|---|--------------------|-------------|-------------|
| INPUT LED | | | |
| Forward Current — Continuous | I _F | 60 | mA |
| Forward Current — Peak (PW = 100 μs, 120 pps) | I _{F(pk)} | 1.0 | A |
| Reverse Voltage | V _R | 6.0 | V |
| LED Power Dissipation @ T _A = 25°C Derate above 25°C | P _D | 90 0.8 | mW mW/°C |
| OUTPUT DARLINGTON | | | |
| Collector-Emitter Voltage | V _{CEO} | 30 | V |
| Collector-Base Voltage | V _{CBO} | 70 | V |
| Emitter-Collector Voltage | V _{ECO} | 7.0 | V |
| Collector Current — Continuous | I _C | 150 | mA |
| Detector Power Dissipation @ T _A = 25°C Derate above 25°C | P _D | 150 1.76 | mW mW/°C |

(continued)

MOC221
MOC222
MOC223

**SMALL OUTLINE
OPTOISOLATORS
DARLINGTON OUTPUT**

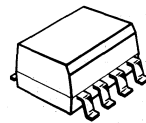

**CASE 846-01
PLASTIC**

SCHEMATIC

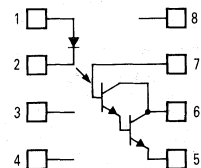

- 1: LED ANODE
- 2: LED CATHODE
- 3: NO CONNECTION
- 4: NO CONNECTION
- 5: EMITTER
- 6: COLLECTOR
- 7: BASE
- 8: NO CONNECTION

MOC221, MOC222, MOC223

MAXIMUM RATINGS — continued ($T_A = 25^\circ\text{C}$ unless otherwise noted)

| Rating | Symbol | Value | Unit |
|--|-----------|-------------|----------------------------|
| TOTAL DEVICE | | | |
| Input-Output Isolation Voltage (1) (60 Hz, 1.0 sec. duration) | V_{ISO} | 2500 | Vac(rms) |
| Total Device Power Dissipation @ $T_A = 25^\circ\text{C}$ Derate above 25°C | P_D | 150 2.94 | mW mW/ $^\circ\text{C}$ |
| Ambient Operating Temperature Range | T_A | -55 to +100 | $^\circ\text{C}$ |
| Storage Temperature Range | T_{stg} | -55 to +150 | $^\circ\text{C}$ |
| Lead Soldering Temperature (1/16" from case, 10 sec. duration) | — | 260 | $^\circ\text{C}$ |

ELECTRICAL CHARACTERISTICS ($T_A = 25^\circ\text{C}$ unless otherwise noted)

| Characteristic | Symbol | Min | Typ | Max | Unit |
|--|--------|-----|------|-----|---------------|
| INPUT LED | | | | | |
| Forward Voltage ($I_F = 1.0\text{ mA}$) | V_F | — | 1.05 | 1.3 | V |
| Reverse Leakage Current ($V_R = 6.0\text{ V}$) | I_R | — | 0.1 | 100 | μA |
| Capacitance | C | — | 18 | — | pF |

OUTPUT DARLINGTON

| | | | | | |
|---|--|------------|-----|-----|----|
| Collector-Emitter Dark Current ($V_{CE} = 5.0\text{ V}, T_A = 25^\circ\text{C}$) | I_{CEO1} | — | 1.0 | 50 | nA |
| | ($V_{CE} = 5.0\text{ V}, T_A = 100^\circ\text{C}$) | I_{CEO2} | — | 1.0 | — |
| Collector-Emitter Breakdown Voltage ($I_C = 100\ \mu\text{A}$) | $V_{(BR)CEO}$ | 30 | 90 | — | V |
| Emitter-Collector Breakdown Voltage ($I_E = 100\ \mu\text{A}$) | $V_{(BR)ECO}$ | 7.0 | 7.8 | — | V |
| Collector-Emitter Capacitance ($f = 1.0\text{ MHz}, V_{CE} = 0$) | C_{CE} | — | 5.5 | — | pF |

COUPLED

| | | | | | | |
|--|----------------------------|---------------|-------------------|------------------|-------------|---------------|
| Output Collector Current ($I_F = 1.0\text{ mA}, V_{CE} = 5.0\text{ V}$) | MOC221 MOC222 MOC223 | I_C | 1.0 2.0 5.0 | 2.0 4.0 10 | — — — | mA |
| Collector-Emitter Saturation Voltage ($I_C = 500\ \mu\text{A}, I_F = 1.0\text{ mA}$) | | $V_{CE(sat)}$ | — | — | 1.0 | V |
| Turn-On Time ($I_F = 5.0\text{ mA}, V_{CC} = 10\text{ V}, R_L = 100\ \Omega$) | | t_{on} | — | 3.5 | — | μs |
| Turn-Off Time ($I_F = 5.0\text{ mA}, V_{CC} = 10\text{ V}, R_L = 100\ \Omega$) | | t_{off} | — | 95 | — | μs |
| Rise Time ($I_F = 5.0\text{ mA}, V_{CC} = 10\text{ V}, R_L = 100\ \Omega$) | | t_r | — | 1.0 | — | μs |
| Fall Time ($I_F = 5.0\text{ mA}, V_{CC} = 10\text{ V}, R_L = 100\ \Omega$) | | t_f | — | 2.0 | — | μs |
| Isolation Voltage ($f = 60\text{ Hz}, t = 1.0\text{ sec.}$) | | V_{ISO} | 2500 | — | — | Vac(rms) |
| Isolation Resistance ($V_{I-O} = 500\text{ V}$) | | R_{ISO} | 10^{11} | — | — | Ω |
| Isolation Capacitance ($V_{I-O} = 0, f = 1.0\text{ MHz}$) | | C_{ISO} | — | 0.2 | — | pF |

(1) Input-Output Isolation Voltage, V_{ISO} , is an internal device dielectric breakdown rating. For this test, pins 1 and 2 are common, and pins 5, 6 and 7 are common.

TYPICAL CHARACTERISTICS

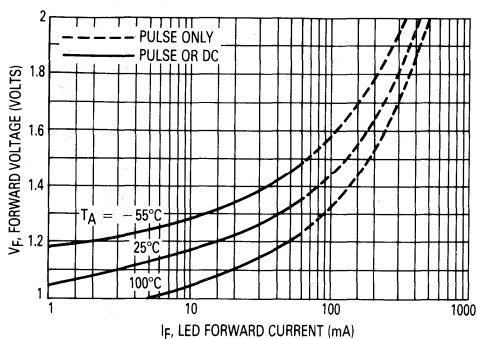

Figure 1. LED Forward Voltage versus Forward Current

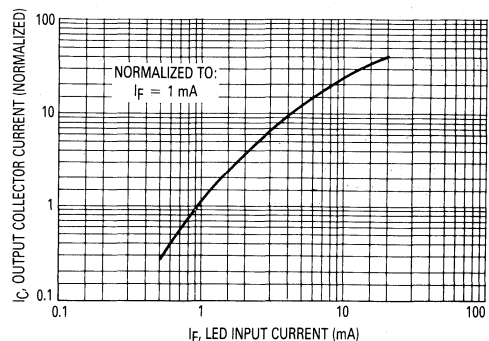

Figure 2. Output Current versus Input Current

MOC221, MOC222, MOC223

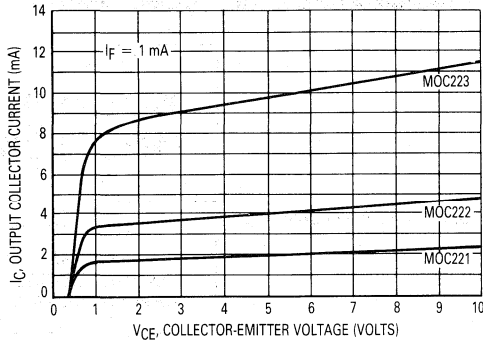

Figure 3. Output Current versus Collector-Emitter Voltage

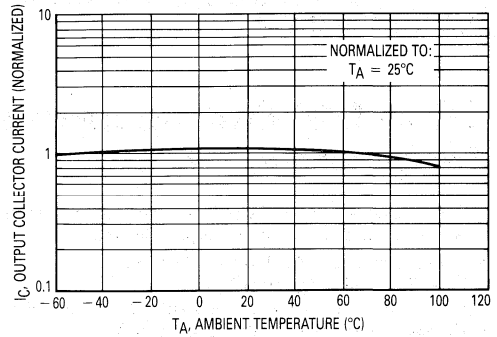

Figure 4. Output Current versus Ambient Temperature

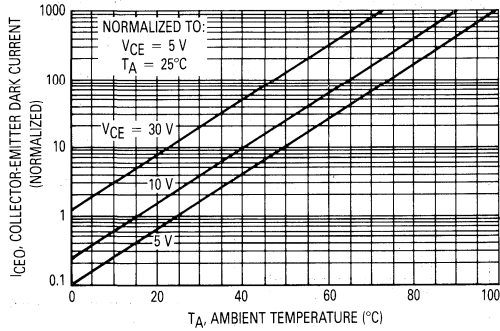

Figure 5. Dark Current versus Ambient Temperature

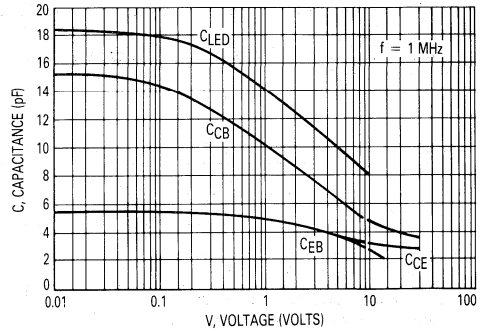

Figure 6. Capacitance versus Voltage

6

OUTLINE DIMENSIONS

CASE 846-01



NOTES:
 1. DIMENSIONING AND TOLERANCING PER ANSI Y14.5M, 1982.
 2. CONTROLLING DIMENSION: INCH.

| DIM | MILLIMETERS | | INCHES | |
|-----|-------------|------|-----------|-------|
| | MIN | MAX | MIN | MAX |
| A | 4.63 | 5.13 | 0.182 | 0.202 |
| B | 3.66 | 4.16 | 0.144 | 0.164 |
| C | 3.13 | 3.63 | 0.123 | 0.143 |
| D | 0.28 | 0.53 | 0.011 | 0.021 |
| G | -1.27 BSC | | 0.050 BSC | |
| H | 0.08 | 0.20 | 0.003 | 0.008 |
| J | 0.16 | 0.25 | 0.006 | 0.010 |
| K | 5.69 | 6.19 | 0.224 | 0.244 |

STYLE 1:
 PIN 1. ANODE
 2. CATHODE
 3. NC
 4. NC
 5. EMITTER
 6. COLLECTOR
 7. BASE
 8. NC

6-Pin DIP Optoisolators Transistor Output

These devices consist of a gallium arsenide infrared emitting diode optically coupled to a monolithic silicon phototransistor detector.

- Convenient Plastic Dual-in-Line Package
- Most Economical Optoisolator
- High Input-Output Isolation Guaranteed — 7500 Volts Peak
- UL Recognized. File Number E54915 
- VDE approved per standard 0883/6.80 (Certificate number 41853), with additional approval to DIN IEC380/VDE0806, IEC435/VDE0805, IEC65/VDE0860, VDE110b, covering all other standards with equal or less stringent requirements, including IEC204/VDE0113, VDE0160, VDE0832, VDE0833, etc. 
- Special lead form available (add suffix "T" to part number) which satisfies VDE0883/6.80 requirement for 8 mm minimum creepage distance between input and output solder pads.
- Various lead form options available. Consult "Optoisolator Lead Form Options" data sheet for details.

MAXIMUM RATINGS ($T_A = 25^\circ\text{C}$ unless otherwise noted)

| Rating | Symbol | Value | Unit |
|--------|--------|-------|------|
|--------|--------|-------|------|

INPUT LED

| | | | |
|---|-------|------|----------------------|
| Reverse Voltage | V_R | 3 | Volts |
| Forward Current — Continuous | I_F | 60 | mA |
| LED Power Dissipation @ $T_A = 25^\circ\text{C}$ with Negligible Power in Output Detector Derate above 25°C | P_D | 120 | mW |
| | | 1.41 | mW/ $^\circ\text{C}$ |

OUTPUT TRANSISTOR

| | | | |
|--|-----------|------|----------------------|
| Collector-Emitter Voltage | V_{CEO} | 30 | Volts |
| Emitter-Collector Voltage | V_{ECO} | 7 | Volts |
| Collector-Base Voltage | V_{CBO} | 70 | Volts |
| Collector Current — Continuous | I_C | 150 | mA |
| Detector Power Dissipation @ $T_A = 25^\circ\text{C}$ with Negligible Power in Input LED Derate above 25°C | P_D | 150 | mW |
| | | 1.76 | mW/ $^\circ\text{C}$ |

TOTAL DEVICE

| | | | |
|--|-----------|-------------|----------------------|
| Isolation Surge Voltage (1) (Peak ac Voltage, 60 Hz, 1 sec Duration) | V_{ISO} | 7500 | Vac |
| Total Device Power Dissipation @ $T_A = 25^\circ\text{C}$ Derate above 25°C | P_D | 250 | mW |
| | | 2.94 | mW/ $^\circ\text{C}$ |
| Ambient Operating Temperature Range | T_A | -55 to +100 | $^\circ\text{C}$ |
| Storage Temperature Range | T_{stg} | -55 to +150 | $^\circ\text{C}$ |
| Soldering Temperature (10 sec, 1/16" from case) | T_{sol} | 260 | $^\circ\text{C}$ |

(1) Isolation surge voltage is an internal device dielectric breakdown rating. For this test, Pins 1 and 2 are common, and Pins 4, 5 and 6 are common.

MOC1005
MOC1006

6-PIN DIP
OPTOISOLATORS
TRANSISTOR OUTPUT

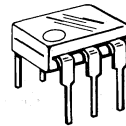

CASE 730A-02
PLASTIC

SCHEMATIC

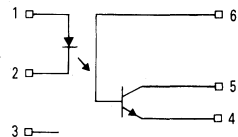

1. LED ANODE
2. LED CATHODE
3. N.C.
4. EMITTER
5. COLLECTOR
6. BASE

MOC1005, MOC1006

ELECTRICAL CHARACTERISTICS (T_A = 25°C unless otherwise noted)

| Characteristic | Symbol | Min | Typ | Max | Unit |
|--|----------------|-----|------|-----|-------|
| INPUT LED | | | | | |
| Forward Voltage (I _F = 10 mA) | V _F | — | 1.15 | 1.5 | Volts |
| T _A = 25°C | | — | 1.3 | — | |
| T _A = -55°C | | — | 1.05 | — | |
| Reverse Leakage Current (V _R = 3 V) | I _R | — | — | 100 | μA |
| Capacitance (V = 0 V, f = 1 MHz) | C _J | — | 18 | — | pF |

OUTPUT TRANSISTOR

| | | | | | |
|--|----------------------|----|-----|-----|-------|
| Collector-Emitter Dark Current (V _{CE} = 10 V) | I _{CEO} | — | 1 | 50 | nA |
| T _A = 25°C | | — | 1 | 100 | μA |
| T _A = 100°C | I _{CBO} | — | 0.2 | 20 | nA |
| Collector-Base Dark Current (V _{CB} = 10 V) | I _{CBO} | — | 0.2 | 20 | nA |
| Collector-Emitter Breakdown Voltage (I _C = 1 mA) | V _{(BR)CEO} | 30 | 45 | — | Volts |
| Collector-Base Breakdown Voltage (I _C = 100 μA) | V _{(BR)CBO} | 70 | 100 | — | Volts |
| Emitter-Collector Breakdown Voltage (I _E = 100 μA) | V _{(BR)ECO} | 7 | 7.8 | — | Volts |
| DC Current Gain (I _C = 2 mA, V _{CE} = 5 V) | h _{FE} | — | 500 | — | — |
| Collector-Emitter Capacitance (f = 1 MHz, V _{CE} = 0) | C _{CE} | — | 7 | — | pF |
| Collector-Base Capacitance (f = 1 MHz, V _{CB} = 0) | C _{CB} | — | 19 | — | pF |
| Emitter-Base Capacitance (f = 1 MHz, V _{EB} = 0) | C _{EB} | — | 9 | — | pF |

COUPLED

| | | | | | | |
|---|--------------------|----------------------|------------------|--------|-----|---------|
| Output Collector Current (I _F = 10 mA, V _{CE} = 10 V) | MOC1005 MOC1006 | I _C | 2 1 | 7 5 | — | mA |
| Collector-Emitter Saturation Voltage (I _C = 2 mA, I _F = 50 mA) | | V _{CE(sat)} | — | 0.15 | 0.5 | Volts |
| Turn-On Time (I _F = 10 mA, V _{CC} = 10 V, R _L = 100 Ω, Figure 11) | | t _{on} | — | 2.8 | — | μs |
| Turn-Off Time (I _F = 10 mA, V _{CC} = 10 V, R _L = 100 Ω, Figure 11) | | t _{off} | — | 4.5 | — | μs |
| Rise Time (I _F = 10 mA, V _{CC} = 10 V, R _L = 100 Ω, Figure 11) | | t _r | — | 1.2 | — | μs |
| Fall Time (I _F = 10 mA, V _{CC} = 10 V, R _L = 100 Ω, Figure 11) | | t _f | — | 1.3 | — | μs |
| Isolation Voltage (f = 60 Hz, t = 1 sec) | | V _{ISO} | 7500 | — | — | Vac(pk) |
| Isolation Resistance (V = 500 V) | | R _{ISO} | 10 ¹¹ | — | — | Ω |
| Isolation Capacitance (V = 0 V, f = 1 MHz) | | C _{ISO} | — | 0.2 | — | pF |

TYPICAL CHARACTERISTICS

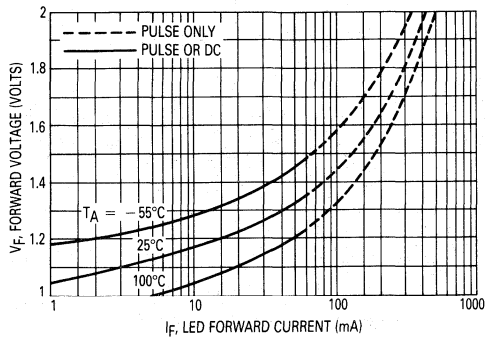

Figure 1. LED Forward Voltage versus Forward Current

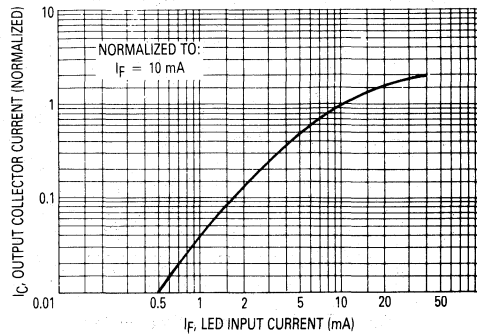

Figure 2. Output Current versus Input Current

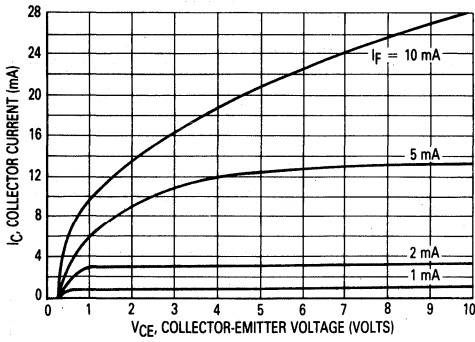

Figure 3. Collector Current versus Collector-Emitter Voltage

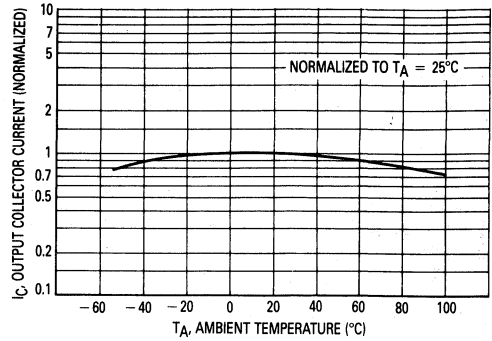

Figure 4. Output Current versus Ambient Temperature

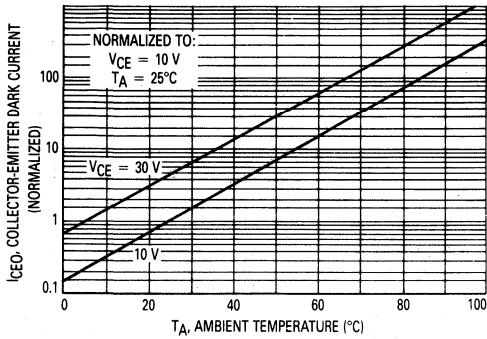

Figure 5. Dark Current versus Ambient Temperature

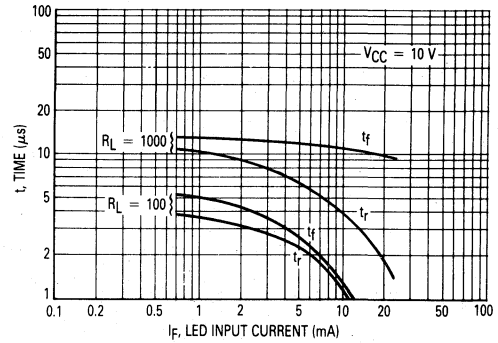

Figure 6. Rise and Fall Times

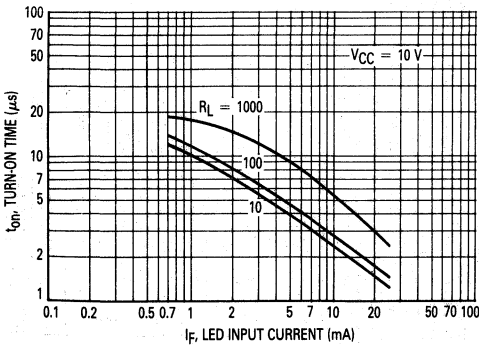

Figure 7. Turn-On Switching Times

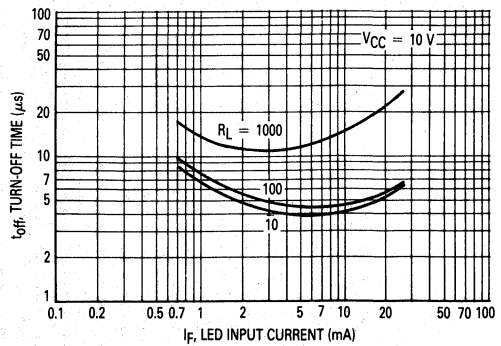

Figure 8. Turn-Off Switching Times

MOC1005, MOC1006

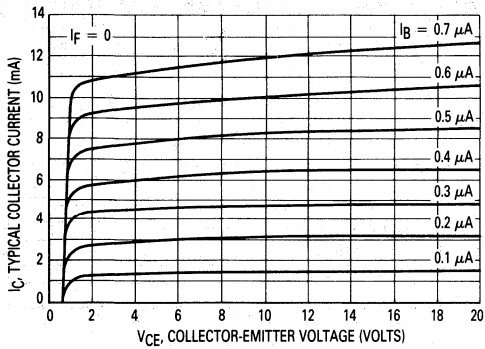

Figure 9. DC Current Gain (Detector Only)

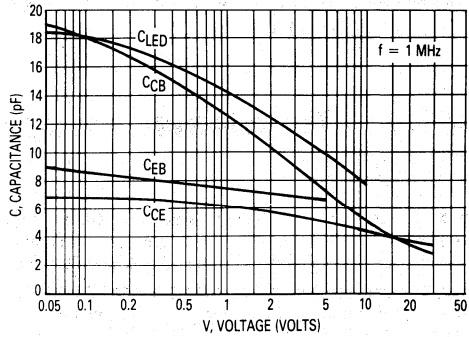

Figure 10. Detector Capacitances versus Voltage

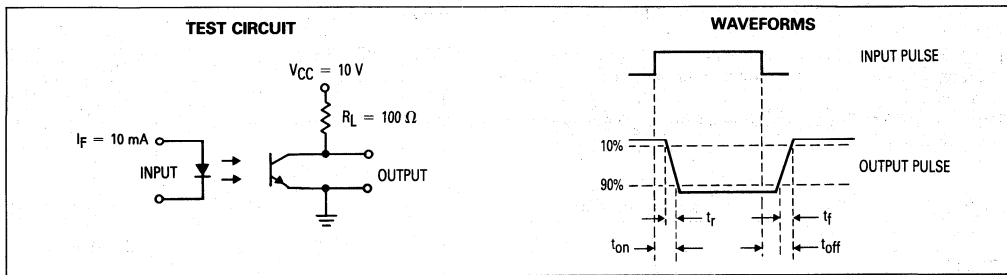
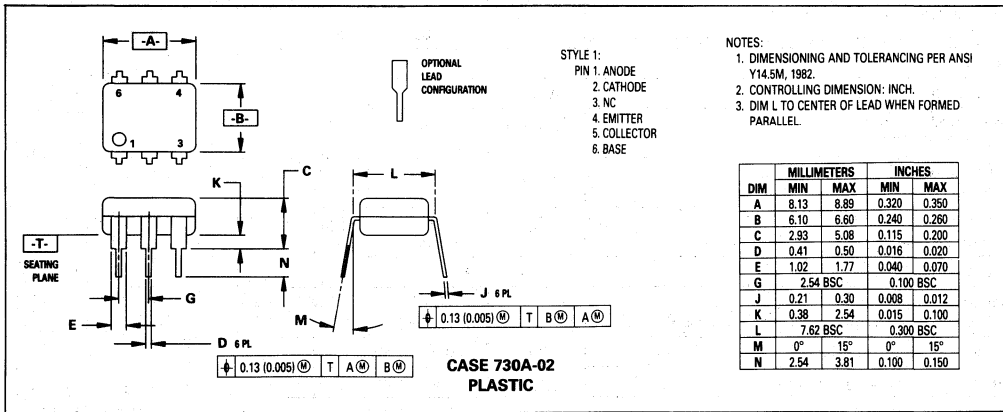



Figure 11. Switching Times

OUTLINE DIMENSIONS



6-Pin DIP Optoisolators SCR Output

These devices consist of gallium-arsenide infrared emitting diode optically coupled to a photo sensitive silicon controlled rectifier (SCR). They are designed for applications requiring high electrical isolation between low voltage control circuitry and the ac line.

- High Blocking Voltage of 400 V for 240 Vac Lines
- Very High Isolation Voltage: $V_{ISO} = 7500$ Vac Min
- Standard 6-Pin DIP
- UL Recognized, File Number E54915 
- VDE approved per standard 0883/6.80 (Certificate number 41853), with additional approval to DIN IEC380/VDE0806, IEC435/VDE0805, IEC65/VDE0860, VDE110b, covering all other standards with equal or less stringent requirements, including IEC204/ 883 VDE0113, VDE0160, VDE0832, VDE0833, etc.
- Special lead form available (add suffix "T" to part number) which satisfies VDE0883/6.80 requirement for 8 mm minimum creepage distance between input and output solder pads.
- Various lead form options available. Consult "Optoisolator Lead Form Options" data sheet for details.

MAXIMUM RATINGS ($T_A = 25^\circ\text{C}$ unless otherwise noted)

| Rating | Symbol | Value | Unit |
|---|--------|-------|----------------------|
| INPUT LED | | | |
| Reverse Voltage | V_R | 7 | Volts |
| Forward Current — Continuous | I_F | 60 | mA |
| Total Power Dissipation @ $T_A = 25^\circ\text{C}$ Negligible Power in Transistor Derate above 25°C | P_D | 100 | mW |
| | | 1.33 | mW/ $^\circ\text{C}$ |

OUTPUT DRIVER

| | | | |
|---|-------------------|------|----------------------|
| Peak Forward Voltage | V_{DM} | 400 | Volts |
| Forward RMS Current (Full Cycle, 50 to 60 Hz) $T_A = 25^\circ\text{C}$ | $I_T(\text{RMS})$ | 300 | mA |
| Peak Nonrepetitive Surge Current (PW = 10 ms) | I_{TSM} | 3 | A |
| Total Power Dissipation @ $T_A = 25^\circ\text{C}$ Derate above 25°C | P_D | 400 | mW |
| | | 5.33 | mW/ $^\circ\text{C}$ |

TOTAL DEVICE

| | | | |
|--|-----------|-------------|------------------|
| Isolation Surge Voltage (1) (Peak ac Voltage, 60 Hz, 5 Second Duration) | V_{ISO} | 7500 | Vac |
| Junction Temperature Range | T_J | -40 to +100 | $^\circ\text{C}$ |
| Ambient Operating Temperature Range | T_A | -55 to +100 | $^\circ\text{C}$ |
| Storage Temperature Range | T_{stg} | -55 to +150 | $^\circ\text{C}$ |
| Soldering Temperature (10 s) | — | 260 | $^\circ\text{C}$ |

(1) Isolation surge voltage, V_{ISO} , is an internal device dielectric breakdown rating.

MOC3000
MOC3001

6-PIN DIP
OPTOISOLATORS
SCR OUTPUT
400 VOLTS

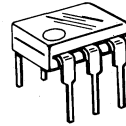

CASE 730A-02
PLASTIC

SCHEMATIC

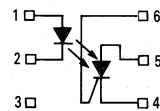

1. ANODE
2. CATHODE
3. N.C.
4. SCR CATHODE
5. SCR ANODE
6. SCR GATE

MOC3000, MOC3001

ELECTRICAL CHARACTERISTICS ($T_A = 25^\circ\text{C}$ unless otherwise noted)

| Characteristic | Symbol | Min | Typ | Max | Unit |
|--|-----------|------|--------------------|----------------------|----------------------|
| INPUT LED | | | | | |
| Reverse Leakage Current ($V_R = 3\text{ V}$) | I_R | — | 0.05 | 10 | μA |
| Forward Voltage ($I_F = 10\text{ mA}$) | V_F | — | 1.2 | 1.5 | Volts |
| Capacitance ($V = 0\text{ V}, f = 1\text{ MHz}$) | C_J | — | 50 | — | pF |
| OUTPUT DETECTOR | | | | | |
| Peak Off-State Voltage ($R_{GK} = 10\text{ k}\Omega, T_A = 100^\circ\text{C}$) | V_{DM} | 400 | — | — | Volts |
| Peak Reverse Voltage ($R_{GK} = 10\text{ k}\Omega, T_A = 100^\circ\text{C}$) | V_{RM} | 400 | — | — | Volts |
| On-State Voltage ($I_{TM} = 0.3\text{ A}$) | V_{TM} | — | 1.1 | 1.3 | Volts |
| Off-State Current ($V_{DM} = 400\text{ V}, T_A = 100^\circ\text{C}, R_{GK} = 10\text{ k}\Omega$) | I_{DM} | — | — | 150 | μA |
| Reverse Current ($V_{RM} = 400\text{ V}, T_A = 100^\circ\text{C}, R_{GK} = 10\text{ k}\Omega$) | I_{RM} | — | — | 150 | μA |
| Capacitance ($V = 0\text{ V}, f = 1\text{ MHz}$) Anode — Gate Gate — Cathode | C_J | — | 20 350 | — | pF |
| COUPLED | | | | | |
| LED Current Required to Trigger ($V_{AK} = 50\text{ V}, R_{GK} = 10\text{ k}\Omega$) ($V_{AK} = 100\text{ V}, R_{GK} = 27\text{ k}\Omega$) | I_{FT} | — | 10 15 6 8 | 20 30 11 14 | mA |
| Isolation Resistance ($V_{IO} = 500\text{ Vdc}$) | R_{ISO} | 100 | — | — | $\text{G}\Omega$ |
| Capacitance Input to Output ($V_{IO} = 0, f = 1\text{ MHz}$) | C_{ISO} | — | — | 2 | pF |
| Coupled dv/dt , Input to Output ($R_{GK} = 10\text{ k}\Omega$) | dv/dt | — | 500 | — | Volts/ μs |
| Isolation Surge Voltage (Peak ac Voltage, 60 Hz, 5 Second Duration) | V_{ISO} | 7500 | — | — | Vac(pk) |

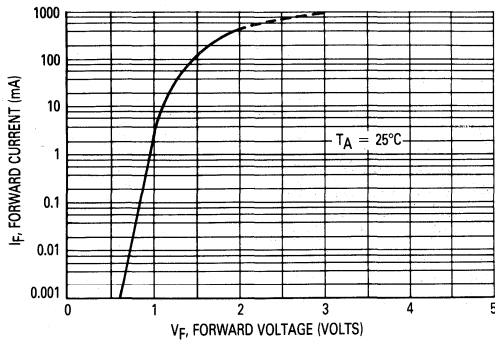

Figure 1. Forward Current versus LED Forward Voltage

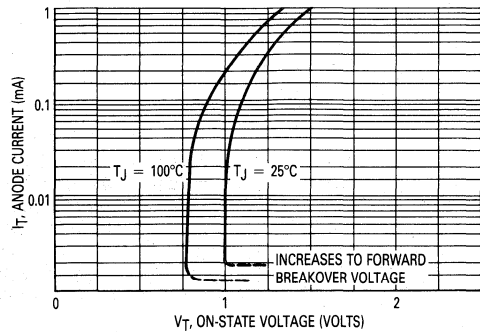

Figure 2. On-State Characteristics

MOC3000, MOC3001

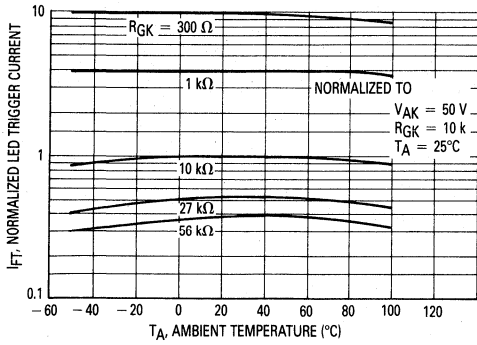

Figure 3. LED Trigger Current versus Temperature

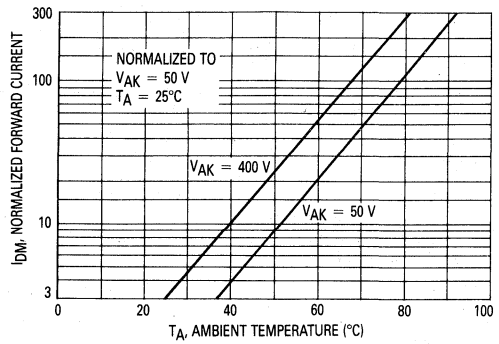
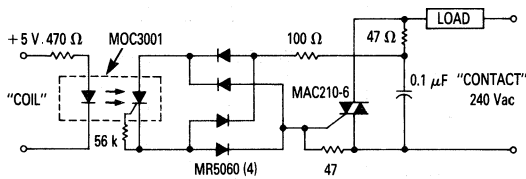

Figure 4. Forward Leakage Current versus Temperature

TYPICAL APPLICATIONS



Use of the MOC3001 for high sensitivity, 7500 V isolation capability, provides this highly reliable solid state relay design. This design is compatible with 74, 74S and 74H series T²L logic systems inputs and 240 Vac loads up to 10 A.

Figure 5. 10 A, T²L Compatible, Solid State Relay

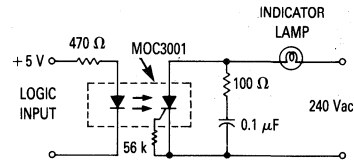

The high surge capability and non-reactive input characteristics of the MOC3001 allow it to directly couple, without buffers, T²L and DTL logic to indicator and alarm devices, without danger of introducing noise and logic glitches.

Figure 6. 25 W Logic Indicator Lamp Driver

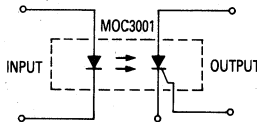

Use of the high voltage PNP portion of the MOC3001 provides a 400 V transistor capable of conducting positive and negative signals with current transfer ratios of over 1%. This function is useful in remote instrumentation, high voltage power supplies and test equipment. Care should be taken not to exceed the device 400 mW power dissipation rating when used at high voltages.

Figure 7. 400 V Symmetrical Transistor Coupler

MOC3000, MOC3001

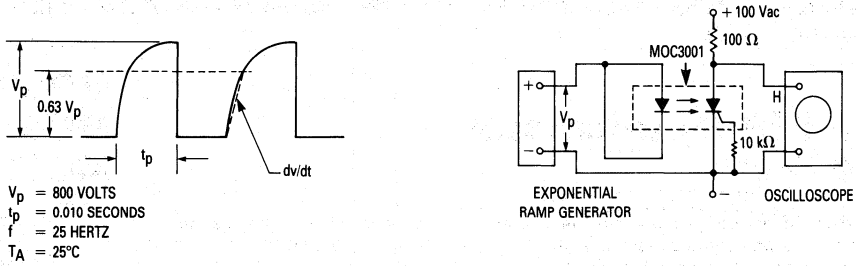
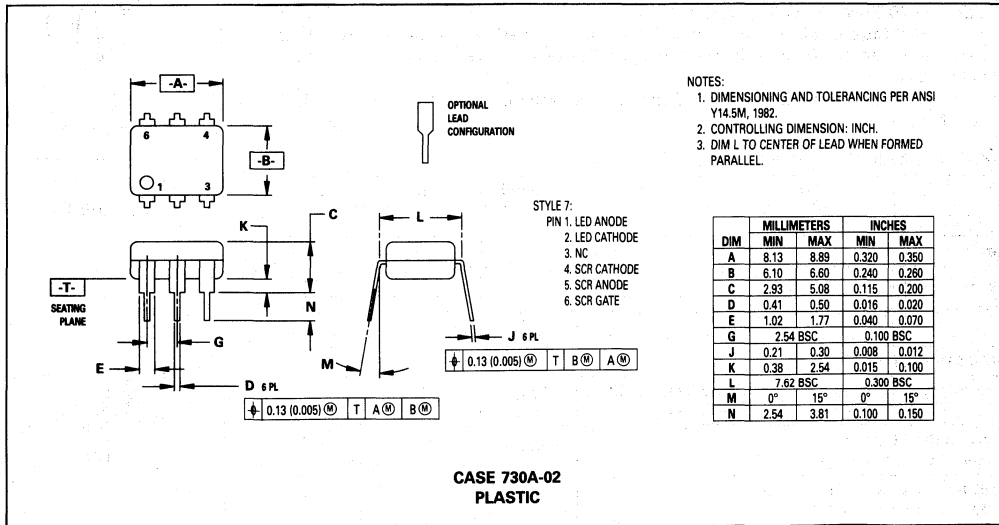



Figure 8. Coupled dv/dt — Test Circuit

OUTLINE DIMENSIONS



6-Pin DIP Optoisolators SCR Output

These devices consist of gallium arsenide infrared-emitting diodes optically coupled to photosensitive silicon controlled rectifiers (SCR). They are designed for applications requiring high electrical isolation between low voltage circuitry, like integrated circuits, and the ac line.

- High Blocking Voltage
 MOC3002, 3003 — 250 V for 120 Vac Lines
 MOC3007 — 200 V for 120 Vac Lines
- Very High Isolation Voltage
 $V_{ISO} = 7500 \text{ Vac (pk) Min}$
- Standard 6-Pin DIP
- UL Recognized, File Number E54915 
- VDE approved per standard 0883/6.80 (Certificate number 41853), with additional approval to DIN IEC380/VDE0806, IEC435/VDE0805, IEC65/VDE0860, VDE110b, covering all other standards with equal or less stringent requirements, including IEC204/VDE0113, VDE0160, VDE0832, VDE0833, etc. 
- Special lead form available (add suffix "T" to part number) which satisfies VDE0883/6.80 requirement for 8 mm minimum creepage distance between input and output solder pads.
- Various lead form options available. Consult "Optoisolator Lead Form Options" data sheet for details.

MAXIMUM RATINGS ($T_A = 25^\circ\text{C}$ unless otherwise noted)

| Rating | Symbol | Value | Unit |
|---|--------|-------------|-------------|
| INPUT LED | | | |
| Reverse Voltage | V_R | 7 | Volts |
| Forward Current — Continuous | I_F | 60 | mA |
| LED Power Dissipation @ $T_A = 25^\circ\text{C}$ Derate above 25°C | P_D | 120 1.41 | mW mW/°C |

OUTPUT DETECTOR

| | | | | |
|--|--------------------------|-------------------|-------------|-------------|
| Peak Forward Voltage | MOC3002, 3003 MOC3007 | V_{DM} | 250 200 | Volts |
| Forward RMS Current (Full Cycle, 50 to 60 Hz) $T_A = 25^\circ\text{C}$ | | $I_T(\text{RMS})$ | 300 | mA |
| Peak Nonrepetitive Surge Current (PW = 10 ms, dc = 10%) | | I_{TSM} | 3 | A |
| Detector Power Dissipation @ $T_A = 25^\circ\text{C}$ Derate above 25°C | | P_D | 150 1.76 | mW mW/°C |

TOTAL DEVICE

| | | | |
|--|-----------|-------------|-------------|
| Isolation Surge Voltage (1) (Peak ac Voltage, 60 Hz, 1 second Duration) | V_{ISO} | 7500 | Vac |
| Total Device Power Dissipation @ $T_A = 25^\circ\text{C}$ Derate above 25°C | P_D | 250 2.94 | mW mW/°C |
| Junction Temperature Range | T_J | -40 to +100 | °C |
| Ambient Operating Temperature Range | T_A | -55 to +100 | °C |
| Storage Temperature Range | T_{stg} | -55 to +150 | °C |
| Soldering Temperature (10 s) | — | 260 | °C |

(1) Isolation surge voltage is an internal device dielectric breakdown rating.

MOC3002
MOC3003
MOC3007

6-PIN DIP
OPTOISOLATORS
SCR OUTPUT
250 AND 200 VOLTS

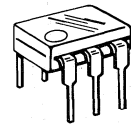

CASE 730A-02
PLASTIC

SCHEMATIC

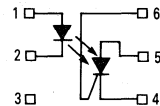

1. LED ANODE
2. LED CATHODE
3. NC
4. SCR CATHODE
5. SCR ANODE
6. SCR GATE

MOC3002, MOC3003, MOC3007

ELECTRICAL CHARACTERISTICS (T_A = 25°C unless otherwise noted)

| Characteristic | Symbol | Min | Typ | Max | Unit |
|----------------|--------|-----|-----|-----|------|
|----------------|--------|-----|-----|-----|------|

INPUT LED

| | | | | | |
|---|----------------|---|------|-----|-------|
| Reverse Leakage Current (V _R = 3 V) | I _R | — | 0.05 | 10 | μA |
| Forward Voltage (I _F = 10 mA) | V _F | — | 1.2 | 1.5 | Volts |
| Capacitance (V = 0 V, f = 1 MHz) | C _J | — | 18 | — | pF |

OUTPUT DETECTOR

| | | | | | | |
|---|--------------------------|-----------------|------------|------------|------------|-------|
| Peak Off-State Voltage (I _{DM} = 50 μA) (R _{GK} = 10 kΩ, T _A = 100°C, I _{DM} = 100 μA) | MOC3002, 3003 MOC3007 | V _{DM} | 250 200 | — 8 | — — | Volts |
| Peak Reverse Voltage (I _{RM} = 50 μA) (R _{GK} = 10 kΩ, T _A = 100°C, I _{RM} = 100 μA) | MOC3002, 3003 MOC3007 | V _{RM} | 250 200 | — — | — — | Volts |
| On-State Voltage (I _{TM} = 0.3 A) | MOC3002, 3003 MOC3007 | V _{TM} | — — | 1.1 1.2 | 1.3 1.5 | Volts |
| Off-State Current (V _{DM} = 250 V, R _{GK} = 10 kΩ, T _A = 100°C) (V _{DM} = 200 V, R _{GK} = 10 kΩ, T _A = 100°C) | MOC3002, 3003 MOC3007 | I _{DM} | — — | — — | 50 100 | μA |
| Reverse Current (V _{RM} = 250 V, R _{GK} = 10 kΩ, T _A = 100°C) (V _{RM} = 200 V, R _{GK} = 10 kΩ, T _A = 100°C) | MOC3002, 3003 MOC3007 | I _{RM} | — — | — — | 50 100 | μA |
| Capacitance (V = 0 V, f = 1 MHz) Anode-Gate Gate-Cathode | | C _J | — — | 20 350 | — — | pF |

COUPLED

| | | | | | | |
|--|-------------------------------|------------------|-------------|----------------|----------------|----------|
| LED Current Required to Trigger (V _{AK} = 50 V, R _{GK} = 10 kΩ) | MOC3002 MOC3003 MOC3007 | I _{FT} | — — — | 15 10 20 | 30 20 40 | mA |
| (V _{AK} = 100 V, R _{GK} = 27 kΩ) | MOC3002 MOC3003 MOC3007 | | — — — | 8 6 12 | 14 11 22 | |
| Isolation Resistance (V _{IO} = 500 Vdc) | | R _{ISO} | 100 | — | — | GΩ |
| Capacitance Input to Output (V _{IO} = 0, f = 1 MHz) | | C _{ISO} | — | 0.2 | 2 | pF |
| Coupled dv/dt, Input to Output (R _{GK} = 10 kΩ) | | dv/dt | — | 500 | — | Volts/μs |
| Isolation Surge Voltage (Peak ac Voltage, 60 Hz, 1 Second Duration) | | V _{ISO} | 7500 | — | — | Vac (pk) |

TYPICAL ELECTRICAL CHARACTERISTICS

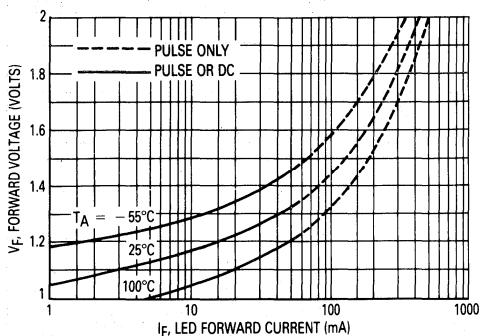

Figure 1. LED Forward Voltage versus Forward Current

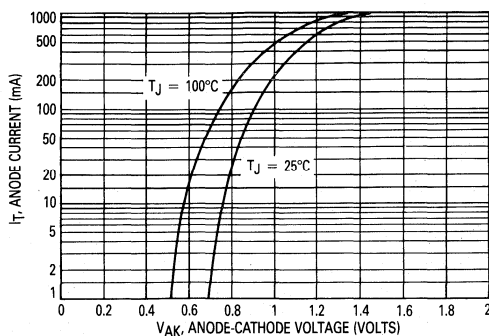

Figure 2. Anode Current versus Anode-Cathode Voltage

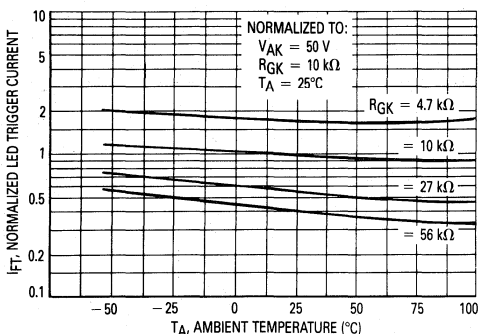

Figure 3. LED Trigger Current versus Temperature

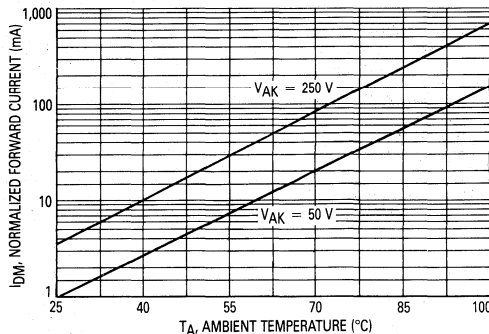

Figure 4. Forward Leakage Current versus Temperature

OUTLINE DIMENSIONS

**CASE 730A-02
PLASTIC**

STYLE 7:

1. LED ANODE
2. LED CATHODE
3. NC
4. SCR CATHODE
5. SCR ANODE
6. SCR GATE

NOTES:

1. DIMENSIONING AND TOLERANCING PER ANSI Y14.5M, 1982.
2. CONTROLLING DIMENSION: INCH.
3. DIM L TO CENTER OF LEAD WHEN FORMED PARALLEL.

| DIM | MILLIMETERS | | INCHES | |
|-----|-------------|------|-----------|-------|
| | MIN | MAX | MIN | MAX |
| A | 8.13 | 8.89 | 0.320 | 0.350 |
| B | 6.10 | 6.60 | 0.240 | 0.260 |
| C | 2.93 | 5.08 | 0.115 | 0.200 |
| D | 0.41 | 0.50 | 0.016 | 0.020 |
| E | 1.02 | 1.77 | 0.040 | 0.070 |
| G | 2.54 BSC | | 0.100 BSC | |
| J | 0.21 | 0.30 | 0.008 | 0.012 |
| K | 0.38 | 2.54 | 0.015 | 0.100 |
| L | 7.62 BSC | | 0.300 BSC | |
| M | 0° | 15° | 0° | 15° |
| N | 2.54 | 3.81 | 0.100 | 0.150 |

6-Pin DIP Optoisolators Triac Driver Output

These devices consist of gallium-arsenide infrared emitting diodes, optically coupled to silicon bilateral switch and are designed for applications requiring isolated triac triggering, low-current isolated ac switching, high electrical isolation (to 7500 V peak), high detector standoff voltage, small size, and low cost.

- UL Recognized File Number 54915
- VDE approved per standard 0883/6.80 (Certificate number 41853), with additional approval to DIN IEC380/VDE0806, IEC435/VDE0805, IEC65/VDE0860, VDE110b, covering all other standards with equal or less stringent requirements, including IEC204/VDE0883/6.80 requirement for 8 mm minimum creepage distance between input and output solder pads.
- Special lead form available (add suffix "T" to part number) which satisfies VDE0883/6.80 requirement for 8 mm minimum creepage distance between input and output solder pads.
- Various lead form options available. Consult "Optoisolator Lead Form Options" data sheet for details.

MAXIMUM RATINGS ($T_A = 25^\circ\text{C}$ unless otherwise noted)

| Rating | Symbol | Value | Unit |
|--------|--------|-------|------|
|--------|--------|-------|------|

INFRARED EMITTING DIODE

| | | | |
|---|-------|------|----------------------|
| Reverse Voltage | V_R | 3 | Volts |
| Forward Current — Continuous | I_F | 60 | mA |
| Total Power Dissipation @ $T_A = 25^\circ\text{C}$ Negligible Power in Transistor Derate above 25°C | P_D | 100 | mW |
| | | 1.33 | mW/ $^\circ\text{C}$ |

OUTPUT DRIVER

| | | | |
|---|-----------|-----|----------------------|
| Off-State Output Terminal Voltage | V_{DRM} | 250 | Volts |
| Peak Repetitive Surge Current (PW = 1 ms, 120 pps) | I_{TSM} | 1 | A |
| Total Power Dissipation @ $T_A = 25^\circ\text{C}$ Derate above 25°C | P_D | 300 | mW |
| | | 4 | mW/ $^\circ\text{C}$ |

TOTAL DEVICE

| | | | |
|---|-----------|-------------|----------------------|
| Isolation Surge Voltage (1) (Peak ac Voltage, 60 Hz, 5 Second Duration) | V_{ISO} | 7500 | Vac |
| Total Power Dissipation @ $T_A = 25^\circ\text{C}$ Derate above 25°C | P_D | 330 | mW |
| | | 4.4 | mW/ $^\circ\text{C}$ |
| Junction Temperature Range | T_J | -40 to +100 | $^\circ\text{C}$ |
| Ambient Operating Temperature Range | T_A | -40 to +85 | $^\circ\text{C}$ |
| Storage Temperature Range | T_{stg} | -40 to +150 | $^\circ\text{C}$ |
| Soldering Temperature (10 s) | — | 260 | $^\circ\text{C}$ |

(1) Isolation surge voltage, V_{ISO} , is an internal device dielectric breakdown rating.

MOC3009
MOC3010
MOC3011
MOC3012

**6-PIN DIP
 OPTOISOLATORS
 TRIAC DRIVER OUTPUT
 250 VOLTS**

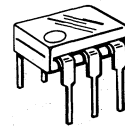

**CASE 730A-02
 PLASTIC**

COUPLER SCHEMATIC

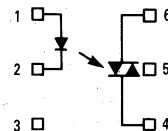

1. ANODE
2. CATHODE
3. NC
4. MAIN TERMINAL
5. SUBSTRATE
DO NOT CONNECT
6. MAIN TERMINAL

MOC3009, MOC3010, MOC3011, MOC3012

ELECTRICAL CHARACTERISTICS ($T_A = 25^\circ\text{C}$ unless otherwise noted)

| Characteristic | Symbol | Min | Typ | Max | Unit |
|----------------|--------|-----|-----|-----|------|
|----------------|--------|-----|-----|-----|------|

INPUT LED

| | | | | | |
|---|-------|---|------|-----|---------------|
| Reverse Leakage Current ($V_R = 3\text{ V}$) | I_R | — | 0.05 | 100 | μA |
| Forward Voltage ($I_F = 10\text{ mA}$) | V_F | — | 1.15 | 1.5 | Volts |

OUTPUT DETECTOR ($I_F = 0$ unless otherwise noted)

| | | | | | |
|--|-----------|---|-----|-----|------------------------|
| Peak Blocking Current, Either Direction (Rated V_{DRM} , Note 1) | I_{DRM} | — | 10 | 100 | nA |
| Peak On-State Voltage, Either Direction ($I_{TM} = 100\text{ mA Peak}$) | V_{TM} | — | 1.8 | 3 | Volts |
| Critical Rate of Rise of Off-State Voltage (Figure 7, Note 2) | dv/dt | — | 10 | — | $\text{V}/\mu\text{s}$ |

COUPLED

| | | | | | | |
|--|---------|----------|---|-----|----|---------------|
| LED Trigger Current, Current Required to Latch Output (Main Terminal Voltage = 3 V, Note 3) | MOC3009 | I_{FT} | — | 15 | 30 | mA |
| | MOC3010 | | | 8 | | |
| | MOC3011 | | | 5 | | |
| | MOC3012 | | | 3 | | |
| | | | | | | |
| Holding Current, Either Direction | | I_H | — | 100 | — | μA |

Notes: 1. Test voltage must be applied within dv/dt rating.

2. This is static dv/dt. See Figure 7 for test circuit. Commutating dv/dt is a function of the load-driving thyristor(s) only.

3. All devices are guaranteed to trigger at an I_F value less than or equal to max I_{FT} . Therefore, recommended operating I_F lies between max I_{FT} (30 mA for MOC3009, 15 mA for MOC3010, 10 mA for MOC3011, 5 mA for MOC3012) and absolute max I_F (60 mA).

TYPICAL ELECTRICAL CHARACTERISTICS

$T_A = 25^\circ\text{C}$

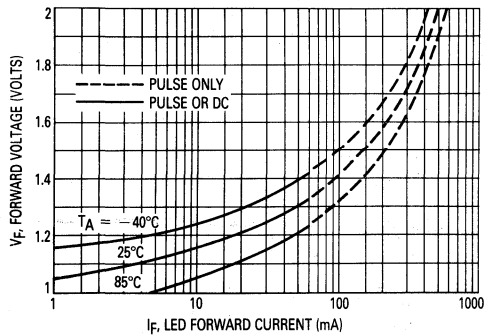

Figure 1. LED Forward Voltage versus Forward Current

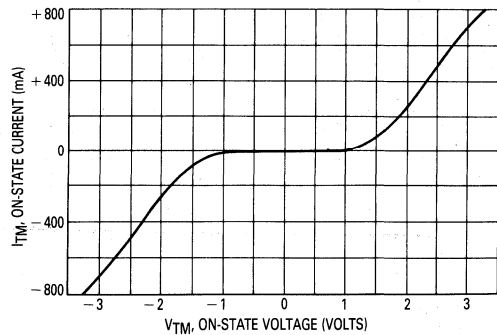

Figure 2. On-State Characteristics

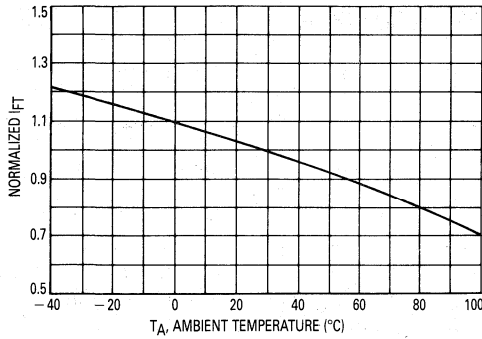

Figure 3. Trigger Current versus Temperature

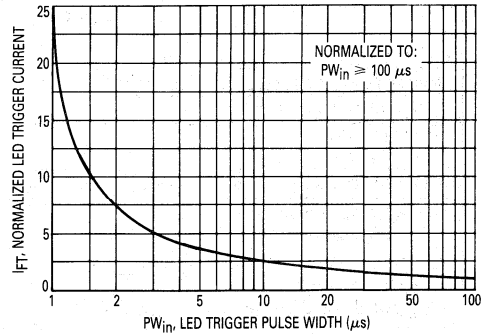

Figure 4. LED Current Required to Trigger versus LED Pulse Width

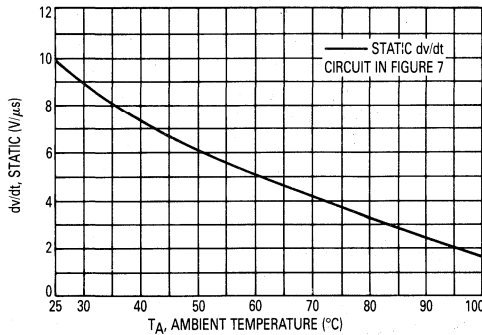

Figure 5. dv/dt versus Temperature

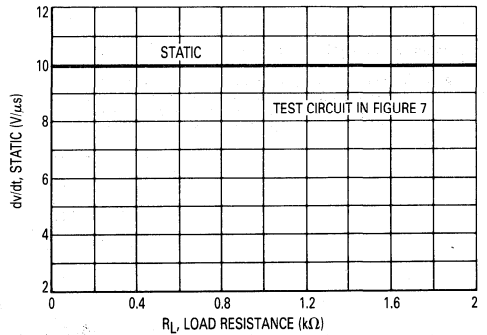
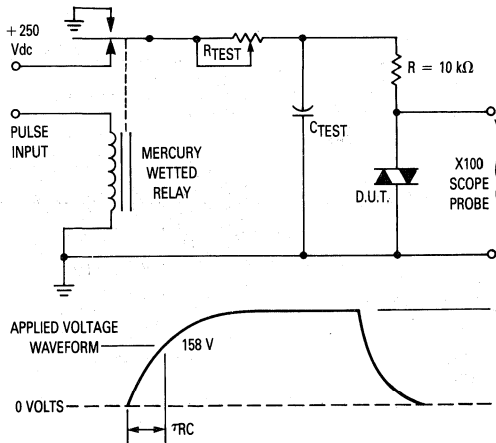

Figure 6. dv/dt versus Load Resistance



1. The mercury wetted relay provides a high speed repeated pulse to the D.U.T.
2. 100x scope probes are used, to allow high speeds and voltages.
3. The worst-case condition for static dv/dt is established by triggering the D.U.T. with a normal LED input current, then removing the current. The variable RTEST allows the dv/dt to be gradually increased until the D.U.T. continues to trigger in response to the applied voltage pulse, even after the LED current has been removed. The dv/dt is then decreased until the D.U.T. stops triggering. τRC is measured at this point and recorded.

Figure 7. Static dv/dt Test Circuit

MOC3009, MOC3010, MOC3011, MOC3012

TYPICAL APPLICATION CIRCUITS

Note: This optoisolator should not be used to drive a load directly. It is intended to be a trigger device only. Additional information on the use of the MOC3009/3010/3011/3012 is available in Application Note AN-780A.

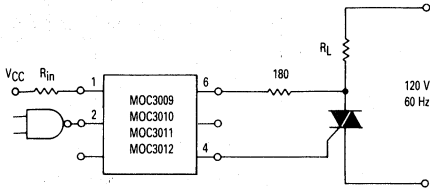

Figure 8. Resistive Load

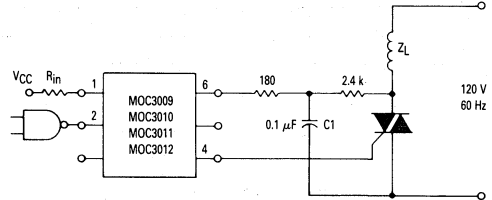

Figure 9. Inductive Load with Sensitive Gate Triac ($I_{GT} \leq 15 \text{ mA}$)

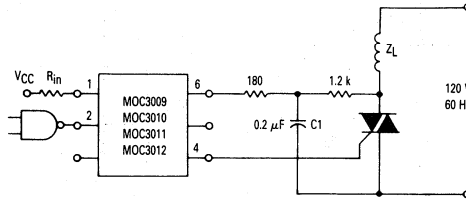
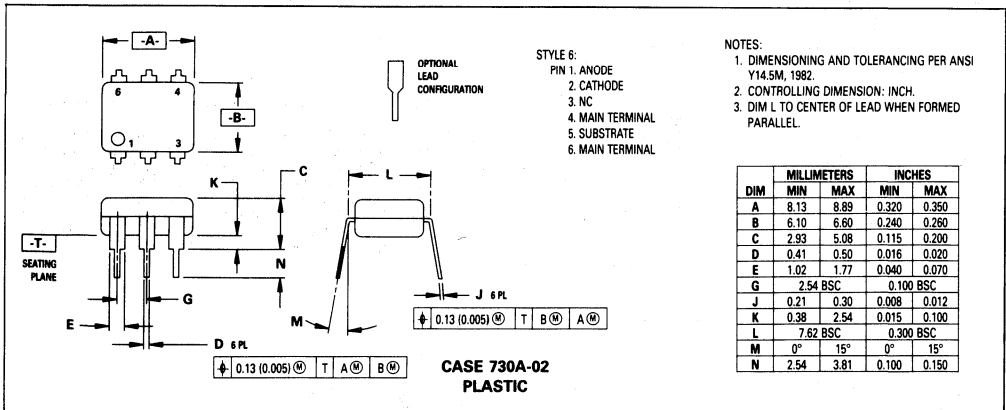

Figure 10. Inductive Load with Non-Sensitive Gate Triac ($15 \text{ mA} < I_{GT} < 50 \text{ mA}$)



OUTLINE DIMENSIONS



6-Pin DIP Optoisolators Triac Driver Output

These devices consist of gallium-arsenide infrared emitting diodes, optically coupled to a silicon bilateral switch.

They are designed for applications requiring isolated triac triggering.

- UL Recognized File Number E54915 
- Output Driver Designed for 240 Vac Line
- V_{ISO} Isolation Voltage of 7500 V Peak
- Similar to MOC3010 and MOC3011
- Standard 6-PIN Plastic DIP
- VDE approved per standard 0883/6.80 (Certificate number 41853), with additional approval to DIN IEC380/VDE0806, IEC435/VDE0805, IEC65/VDE0860, VDE110b, covering all other standards with equal or less stringent requirements, including IEC204/VDE0113, VDE0160, VDE0832, VDE0833, etc. 
- Special lead form available (add suffix "T" to part number) which satisfies VDE0883/6.80 requirement for 8 mm minimum creepage distance between input and output solder pads.
- Various lead form options available. Consult "Optoisolator Lead Form Options" data sheet for details.

MAXIMUM RATINGS ($T_A = 25^\circ\text{C}$ unless otherwise noted)

| Rating | Symbol | Value | Unit |
|--------|--------|-------|------|
|--------|--------|-------|------|

INFRARED EMITTING DIODE

| | | | |
|---|-------|------|----------------------|
| Reverse Voltage | V_R | 3 | Volts |
| Forward Current — Continuous | I_F | 60 | mA |
| Total Power Dissipation @ $T_A = 25^\circ\text{C}$ Negligible Power in Triac Driver Derate above 25°C | P_D | 100 | mW |
| | | 1.33 | mW/ $^\circ\text{C}$ |

OUTPUT DRIVER

| | | | |
|---|-----------|-----|----------------------|
| Off-State Output Terminal Voltage | V_{DRM} | 400 | Volts |
| Peak Repetitive Surge Current ($PW = 1 \text{ ms}, 120 \text{ pps}$) | I_{TSM} | 1 | A |
| Total Power Dissipation @ $T_A = 25^\circ\text{C}$ Derate above 25°C | P_D | 300 | mW |
| | | 4 | mW/ $^\circ\text{C}$ |

TOTAL DEVICE

| | | | |
|---|-----------|-------------|----------------------|
| Isolation Surge Voltage (1) (Peak ac Voltage, 60 Hz, 5 Second Duration) | V_{ISO} | 7500 | Vac |
| Total Power Dissipation @ $T_A = 25^\circ\text{C}$ Derate above 25°C | P_D | 330 | mW |
| | | 4.4 | mW/ $^\circ\text{C}$ |
| Junction Temperature Range | T_J | -40 to +100 | $^\circ\text{C}$ |
| Ambient Operating Temperature Range | T_A | -40 to +85 | $^\circ\text{C}$ |
| Storage Temperature Range | T_{stg} | -40 to +150 | $^\circ\text{C}$ |
| Soldering Temperature (10 s) | — | 260 | $^\circ\text{C}$ |

(1) Isolation surge voltage, V_{ISO} , is an internal device dielectric breakdown rating.

MOC3020
MOC3021
MOC3022
MOC3023

6-PIN DIP
OPTOISOLATORS
TRIAC DRIVER OUTPUT

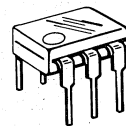

CASE 730A-02
PLASTIC

COUPLER SCHEMATIC

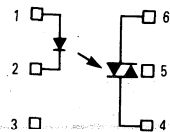

1. ANODE
2. CATHODE
3. NC
4. MAIN TERMINAL
5. SUBSTRATE
DO NOT CONNECT
6. MAIN TERMINAL

MOC3020, MOC3021, MOC3022, MOC3023

ELECTRICAL CHARACTERISTICS ($T_A = 25^\circ\text{C}$ unless otherwise noted)

| Characteristic | Symbol | Min | Typ | Max | Unit |
|--|-----------|-----|---------|-----|------------------------|
| INPUT LED | | | | | |
| Reverse Leakage Current ($V_R = 3\text{ V}$) | I_R | — | 0.05 | 100 | μA |
| Forward Voltage ($I_F = 10\text{ mA}$) | V_F | — | 1.15 | 1.5 | Volts |
| OUTPUT DETECTOR ($I_F = 0$ unless otherwise noted) | | | | | |
| Peak Blocking Current, Either Direction (Rated V_{DRM} , Note 1) | I_{DRM} | — | 10 | 100 | nA |
| Peak On-State Voltage, Either Direction ($I_{TM} = 100\text{ mA Peak}$) | V_{TM} | — | 1.8 | 3 | Volts |
| Critical Rate of Rise of Off-State Voltage (Figure 7, Note 2) | dv/dt | — | 10 | — | $\text{V}/\mu\text{s}$ |
| COUPLED | | | | | |
| LED Trigger Current, Current Required to Latch Output (Main Terminal Voltage = 3 V, Note 3) | I_{FT} | — | 15 | 30 | mA |
| | | | MOC3020 | 8 | 15 |
| | | | MOC3021 | — | 10 |
| | | | MOC3022 | — | 5 |
| | | | MOC3023 | — | — |
| Holding Current, Either Direction | I_H | — | 100 | — | μA |

- Notes: 1. Test voltage must be applied within dv/dt rating.
 2. This is static dv/dt . See Figure 7 for test circuit. Commutating dv/dt is a function of the load-driving thyristor(s) only.
 3. All devices are guaranteed to trigger at an I_F value less than or equal to max I_{FT} . Therefore, recommended operating I_F lies between max I_{FT} (30 mA for MOC3020, 15 mA for MOC3021, 10 mA for MOC3022, 5 mA for MOC3023) and absolute max I_F (60 mA).

TYPICAL ELECTRICAL CHARACTERISTICS

$T_A = 25^\circ\text{C}$

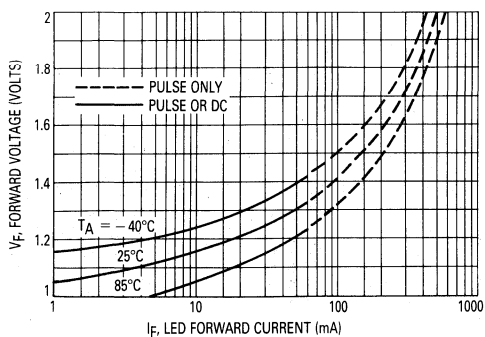

Figure 1. LED Forward Voltage versus Forward Current

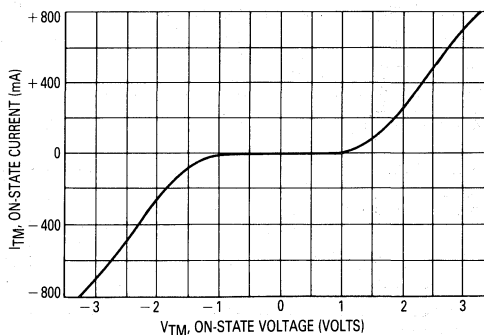

Figure 2. On-State Characteristics

6

MOC3020, MOC3021, MOC3022, MOC3023

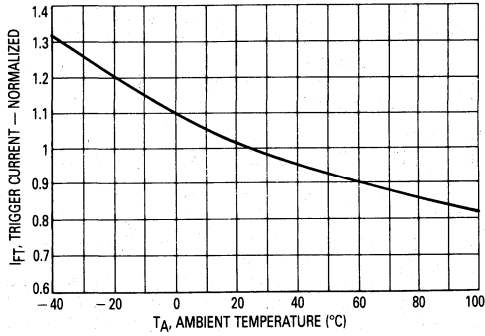

Figure 3. Trigger Current versus Temperature

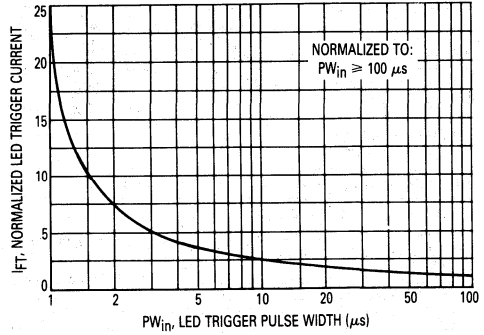

Figure 4. LED Current Required to Trigger versus LED Pulse Width

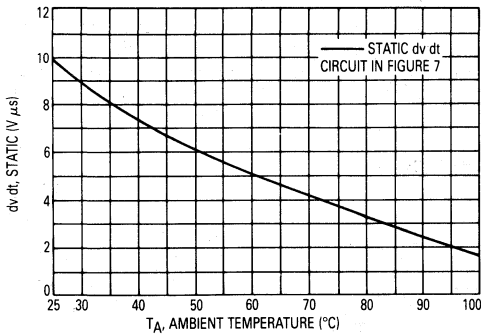

Figure 5. dv/dt versus Temperature

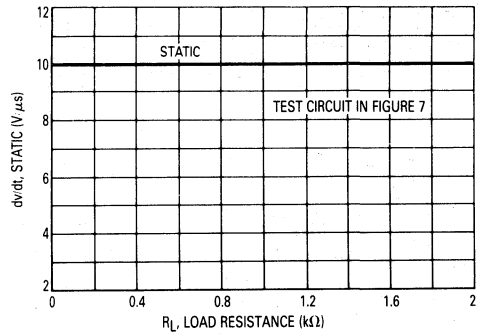
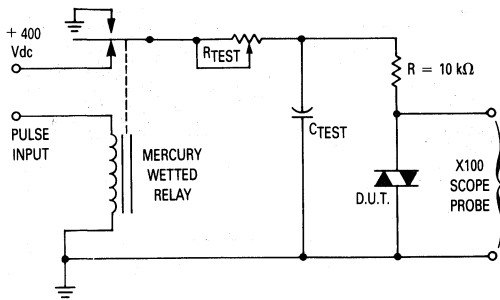

Figure 6. dv/dt versus Load Resistance



1. The mercury wetted relay provides a high speed repeated pulse to the D.U.T.
2. 100x scope probes are used, to allow high speeds and voltages.
3. The worst-case condition for static dv/dt is established by triggering the D.U.T. with a normal LED input current, then removing the current. The variable R_{TEST} allows the dv/dt to be gradually increased until the D.U.T. continues to trigger in response to the applied voltage pulse, even after the LED current has been removed. The dv/dt is then decreased until the D.U.T. stops triggering. τ_{RC} is measured at this point and recorded.

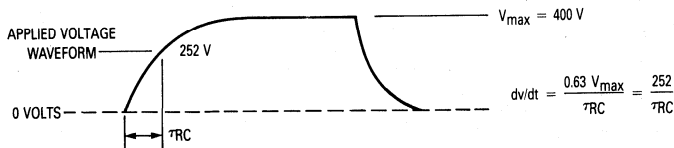
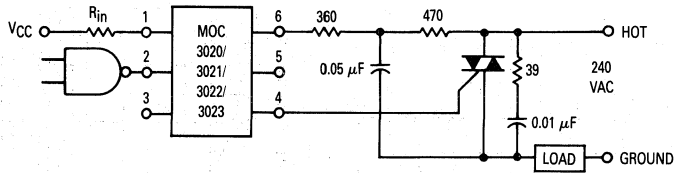

Figure 7. Static dv/dt Test Circuit

MOC3020, MOC3021, MOC3022, MOC3023



*This optoisolator should not be used to drive a load directly. It is intended to be a trigger device only. Additional information on the use of optically coupled triac drivers is available in Application Note AN-780A.

In this circuit the "hot" side of the line is switched and the load connected to the cold or ground side.

The 39 ohm resistor and 0.01 μ F capacitor are for snubbing of the triac, and the 470 ohm resistor and 0.05 μ F capacitor are for snubbing of the coupler. These components may or may not be necessary depending upon the particular triac and load used.

Figure 8. Typical Application Circuit

OUTLINE DIMENSIONS

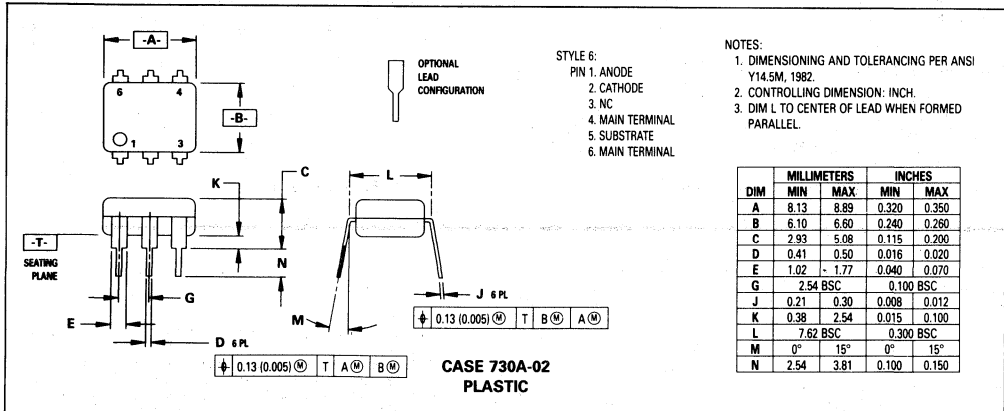



6

6-Pin DIP Optoisolators Triac Driver Output

These devices consist of gallium arsenide infrared emitting diodes optically coupled to a monolithic silicon detector performing the function of a Zero Voltage crossing bilateral triac driver.

They are designed for use with a triac in the interface of logic systems to equipment powered from 115 Vac lines, such as teletypewriters, CRTs, printers, motors, solenoids and consumer appliances, etc.

- Simplifies Logic Control of 115 Vac Power
- Zero Voltage Crossing
- High Breakdown Voltage: $V_{DRM} = 250$ V Min
- High Isolation Voltage: $V_{ISO} = 7500$ V Guaranteed
- Small, Economical, 6-Pin DIP Package
- dv/dt of 2000 V/ μ s Typ, 1000 V/ μ s Guaranteed
- UL Recognized, File No. E54915 
- VDE approved per standard 0883/6.80 (Certificate number 41853), with additional approval to DIN IEC380/VDE0806, IEC435/VDE0805, IEC65/VDE0860, VDE0110b, covering all other standards with equal or less stringent requirements, including IEC204/VDE0113, VDE0160, VDE0832, VDE0833, etc. 
- Special lead form available (add suffix "T" to part number) which satisfies VDE0883/6.80 requirement for 8 mm minimum creepage distance between input and output solder pads.
- Various lead form options available. Consult "Optoisolator Lead Form Options" data sheet for details.

MAXIMUM RATINGS ($T_A = 25^\circ\text{C}$ unless otherwise noted)

| Rating | Symbol | Value | Unit |
|--------|--------|-------|------|
|--------|--------|-------|------|

INFRARED LED

| | | | |
|--|-------|------|----------------------|
| Reverse Voltage | V_R | 3 | Volts |
| Forward Current — Continuous | I_F | 60 | mA |
| Total Power Dissipation @ $T_A = 25^\circ\text{C}$ Negligible Power in Output Driver Derate above 25°C | P_D | 120 | mW |
| | | 1.41 | mW/ $^\circ\text{C}$ |

OUTPUT DRIVER

| | | | |
|---|-----------|------|----------------------|
| Off-State Output Terminal Voltage | V_{DRM} | 250 | Volts |
| Peak Repetitive Surge Current ($PW = 100 \mu\text{s}$, 120 pps) | I_{TSM} | 1 | A |
| Total Power Dissipation @ $T_A = 25^\circ\text{C}$ Derate above 25°C | P_D | 150 | mW |
| | | 1.76 | mW/ $^\circ\text{C}$ |

TOTAL DEVICE

| | | | |
|---|-----------|-------------|----------------------------|
| Isolation Surge Voltage (1) (Peak ac Voltage, 60 Hz, 1 Second Duration) | V_{ISO} | 7500 | Vac |
| Total Power Dissipation @ $T_A = 25^\circ\text{C}$ Derate above 25°C | P_D | 250 2.94 | mW mW/ $^\circ\text{C}$ |
| Junction Temperature Range | T_J | -40 to +100 | $^\circ\text{C}$ |
| Ambient Operating Temperature Range | T_A | -40 to +85 | $^\circ\text{C}$ |
| Storage Temperature Range | T_{stg} | -40 to +150 | $^\circ\text{C}$ |
| Soldering Temperature (10 s) | — | 260 | $^\circ\text{C}$ |

MOC3031
MOC3032
MOC3033

6-PIN DIP
OPTOISOLATORS
TRIAC DRIVER OUTPUT
115 VOLTS AC (RMS)

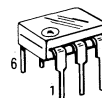

CASE 730A-02
PLASTIC

COUPLER SCHEMATIC

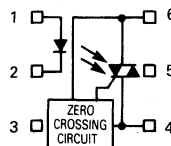

1. ANODE
2. CATHODE
3. NC
4. MAIN TERMINAL
5. SUBSTRATE
DO NOT CONNECT
6. MAIN TERMINAL

MOC3031, MOC3032, MOC3033

ELECTRICAL CHARACTERISTICS ($T_A = 25^\circ\text{C}$ unless otherwise noted)

| Characteristic | Symbol | Min | Typ | Max | Unit |
|----------------|--------|-----|-----|-----|------|
|----------------|--------|-----|-----|-----|------|

INPUT LED

| | | | | | |
|---|-------|---|------|-----|---------------|
| Reverse Leakage Current ($V_R = 3\text{ V}$) | I_R | — | 0.05 | 100 | μA |
| Forward Voltage ($I_F = 30\text{ mA}$) | V_F | — | 1.3 | 1.5 | Volts |

OUTPUT DETECTOR ($I_F = 0$ unless otherwise noted)

| | | | | | |
|--|------------|------|------|-----|------------------|
| Leakage with LED Off, Either Direction (Rated V_{DRM} , Note 1) | I_{DRM1} | — | 10 | 100 | nA |
| Peak On-State Voltage, Either Direction ($I_{TM} = 100\text{ mA Peak}$) | V_{TM} | — | 1.8 | 3 | Volts |
| Critical Rate of Rise of Off-State Voltage | dv/dt | 1000 | 2000 | — | V/ μs |

COUPLED

| | | | | | |
|--|-----------|------|-----|----|---------------|
| LED Trigger Current, Current Required to Latch Output (Main Terminal Voltage = 3 V, Note 2) | I_{FT} | — | — | 15 | mA |
| | | | | 10 | |
| | | | | 5 | |
| Holding Current, Either Direction | I_H | — | 100 | — | μA |
| Isolation Voltage ($f = 60\text{ Hz}$, $t = 1\text{ sec}$) | V_{ISO} | 7500 | — | — | Vac(pk) |

ZERO CROSSING

| | | | | | |
|---|------------|---|---|-----|---------------|
| Inhibit Voltage ($I_F = \text{Rated } I_{FT}$, MT1-MT2 Voltage above which device will not trigger.) | V_{IH} | — | 5 | 20 | Volts |
| Leakage in Inhibited State ($I_F = \text{Rated } I_{FT}$, Rated V_{DRM} , Off State) | I_{DRM2} | — | — | 500 | μA |

Notes: 1. Test voltage must be applied within dv/dt rating.

2. All devices are guaranteed to trigger at an I_F value less than or equal to max I_{FT} . Therefore, recommended operating I_F lies between max I_{FT} (15 mA for MOC3031, 10 mA for MOC3032, 5 mA for MOC3033) and absolute max I_F (60 mA).

TYPICAL ELECTRICAL CHARACTERISTICS

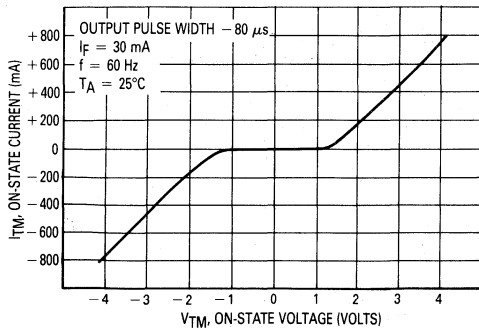

Figure 1. On-State Characteristics

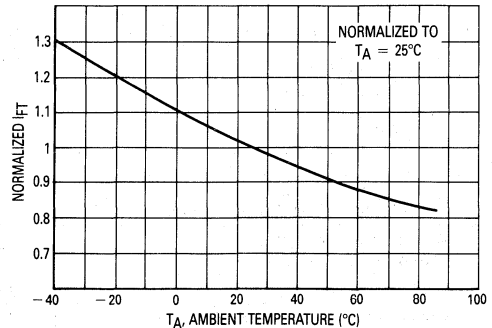

Figure 2. Trigger Current versus Temperature

MOC3031, MOC3032, MOC3033

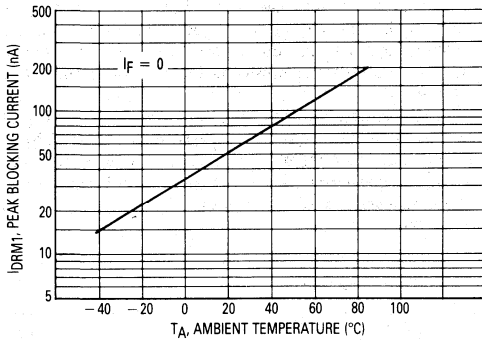

Figure 3. IDRM1, Peak Blocking Current versus Temperature

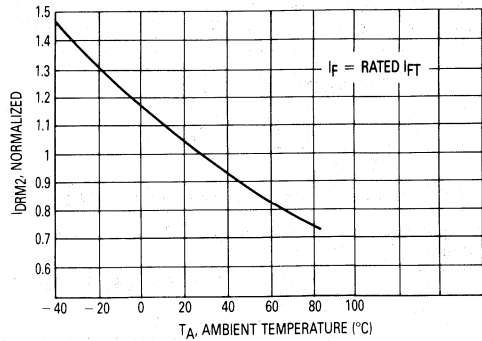

Figure 4. IDRM2, Leakage in Inhibit State versus Temperature

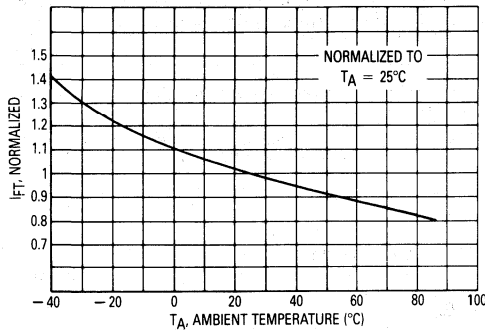

Figure 5. Trigger Current versus Temperature

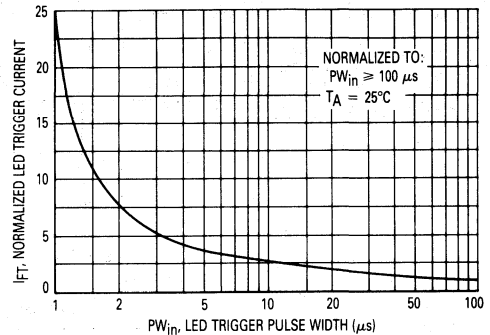

Figure 6. LED Current Required to Trigger versus LED Pulse Width

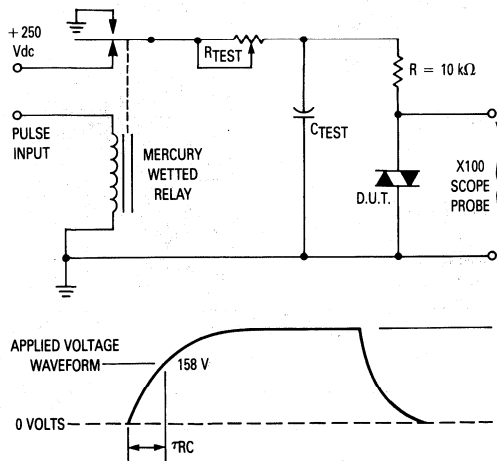
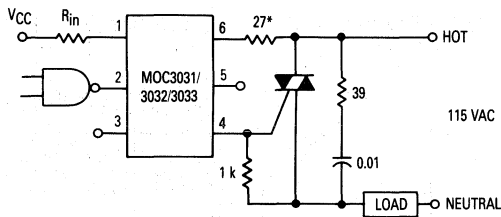

Figure 7. Static dv/dt Test Circuit

1. The mercury wetted relay provides a high speed repeated pulse to the D.U.T.
2. 100x scope probes are used, to allow high speeds and voltages.
3. The worst-case condition for static dv/dt is established by triggering the D.U.T. with a normal LED input current, then removing the current. The variable R_{TEST} allows the dv/dt to be gradually increased until the D.U.T. continues to trigger in response to the applied voltage pulse, even after the LED current has been removed. The dv/dt is then decreased until the D.U.T. stops triggering. τ_{RC} is measured at this point and recorded.

MOC3031, MOC3032, MOC3033



*For highly inductive loads (power factor < 0.5), change this value to 360 ohms.

Figure 8. Hot-Line Switching Application Circuit

Typical circuit for use when hot line switching is required. In this circuit the "hot" side of the line is switched and the load connected to the cold or neutral side. The load may be connected to either the neutral or hot line.

R_{in} is calculated so that I_F is equal to the rated I_{FT} of the part, 5 mA for the MOC3033, 10 mA for the MOC3032, or 15 mA for the MOC3031. The 39 ohm resistor and 0.01 μ F capacitor are for snubbing of the triac and may or may not be necessary depending upon the particular triac and load used.

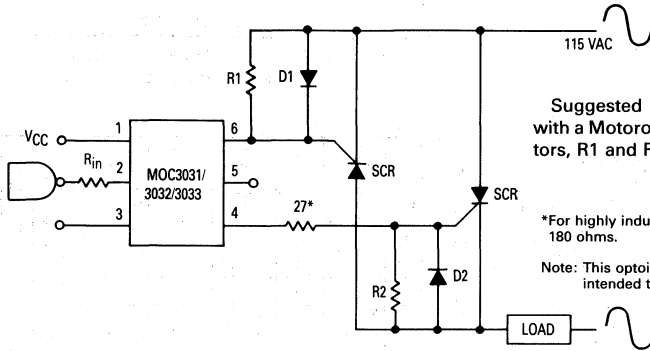

Suggested method of firing two, back-to-back SCR's, with a Motorola triac driver. Diodes can be 1N4001; resistors, R1 and R2, are optional 1 k ohm.

*For highly inductive loads (power factor < 0.5), change this value to 180 ohms.

Note: This optoisolator should not be used to drive a load directly. It is intended to be a trigger device only.

Figure 9. Inverse-Parallel SCR Driver Circuit

OUTLINE DIMENSIONS

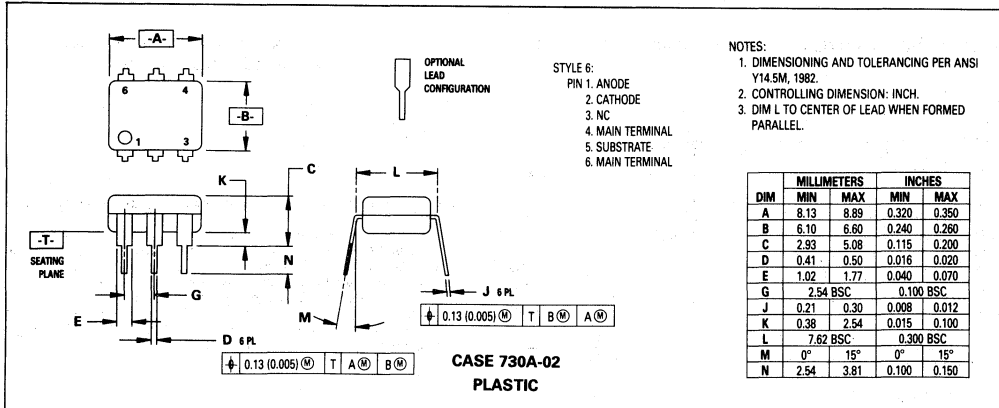



6

6-Pin DIP Optoisolators Triac Driver Output

These devices consist of gallium arsenide infrared emitting diodes optically coupled to a monolithic silicon detector performing the function of a Zero Voltage Crossing bilateral triac driver.

They are designed for use with a triac in the interface of logic systems to equipment powered from 240 Vac lines, such as solid-state relays, industrial controls, motors, solenoids and consumer appliances, etc.

- Simplifies Logic Control of 240 Vac Power
- Zero Voltage Crossing
- High Breakdown Voltage: $V_{DRM} = 400$ V Min
- High Isolation Voltage: $V_{ISO} = 7500$ V Guaranteed
- Small, Economical, 6-Pin DIP Package
- dv/dt of 2000 V/ μs Typ, 1000 V/ μs Guaranteed
- UL Recognized, File No. E54915 
- VDE approved per standard 0883/6.80 (Certificate number 41853), with additional approval to DIN IEC380/VDE0806, IEC435/VDE0805, IEC65/VDE0860, VDE0110b, covering all other standards with equal or less stringent requirements, including  883 IEC204/VDE0113, VDE0160, VDE0832, VDE0833, etc.
- Special lead form available (add suffix "T" to part number) which satisfies VDE0883/6.80 requirement for 8 mm minimum creepage distance between input and output solder pads.
- Various lead form options available. Consult "Optoisolator Lead Form Options" data sheet for details.

MAXIMUM RATINGS ($T_A = 25^\circ C$ unless otherwise noted)

| Rating | Symbol | Value | Unit |
|--------|--------|-------|------|
|--------|--------|-------|------|

INFRARED EMITTING DIODE

| | | | |
|--|-------|------|----------------|
| Reverse Voltage | V_R | 6 | Volts |
| Forward Current — Continuous | I_F | 60 | mA |
| Total Power Dissipation @ $T_A = 25^\circ C$ Negligible Power in Output Driver Derate above $25^\circ C$ | P_D | 120 | mW |
| | | 1.41 | mW/ $^\circ C$ |

OUTPUT DRIVER

| | | | |
|---|-----------|------|----------------|
| Off-State Output Terminal Voltage | V_{DRM} | 400 | Volts |
| Peak Repetitive Surge Current ($PW = 100 \mu s$, 120 pps) | I_{TSM} | 1 | A |
| Total Power Dissipation @ $T_A = 25^\circ C$ Derate above $25^\circ C$ | P_D | 150 | mW |
| | | 1.76 | mW/ $^\circ C$ |

TOTAL DEVICE

| | | | |
|--|-----------|-------------|----------------------|
| Isolation Surge Voltage (1) (Peak ac Voltage, 60 Hz, 1 Second Duration) | V_{ISO} | 7500 | Vac |
| Total Power Dissipation @ $T_A = 25^\circ C$ Derate above $25^\circ C$ | P_D | 250 2.94 | mW mW/ $^\circ C$ |
| Junction Temperature Range | T_J | -40 to +100 | $^\circ C$ |
| Ambient Operating Temperature Range | T_A | -40 to +85 | $^\circ C$ |
| Storage Temperature Range | T_{stg} | -40 to +150 | $^\circ C$ |
| Soldering Temperature (10 s) | — | 260 | $^\circ C$ |

(1) Isolation surge voltage, V_{ISO} , is an internal device dielectric breakdown rating. For this test, Pins 1 and 2 are common, and Pins 4, 5 and 6 are common.

MOC3041
MOC3042
MOC3043

6-PIN DIP
OPTOISOLATORS
TRIAC DRIVER OUTPUT
400 VOLTS



CASE 730A-02
PLASTIC

COUPLER SCHEMATIC

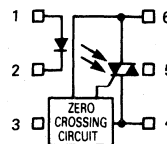

1. ANODE
2. CATHODE
3. NC
4. MAIN TERMINAL
5. SUBSTRATE
DO NOT CONNECT
6. MAIN TERMINAL

MOC3041, MOC3042, MOC3043

ELECTRICAL CHARACTERISTICS (T_A = 25°C unless otherwise noted)

| Characteristic | Symbol | Min | Typ | Max | Unit |
|----------------|--------|-----|-----|-----|------|
|----------------|--------|-----|-----|-----|------|

INPUT LED

| | | | | | |
|---|----------------|---|------|-----|-------|
| Reverse Leakage Current (V _R = 6 V) | I _R | — | 0.05 | 100 | μA |
| Forward Voltage (I _F = 30 mA) | V _F | — | 1.3 | 1.5 | Volts |

OUTPUT DETECTOR (I_F = 0 unless otherwise noted)

| | | | | | |
|---|-------------------|------|------|-----|-------|
| Leakage with LED Off, Either Direction (Rated V _{DRM} , Note 1) | I _{DRM1} | — | 2 | 100 | nA |
| Peak On-State Voltage, Either Direction (I _{TM} = 100 mA Peak) | V _{TM} | — | 1.8 | 3 | Volts |
| Critical Rate of Rise of Off-State Voltage (Note 3) | dv/dt | 1000 | 2000 | — | V/μs |

COUPLED

| | | | | | |
|--|------------------|------|-----|----|---------|
| LED Trigger Current, Current Required to Latch Output (Main Terminal Voltage = 3 V, Note 2) | I _{FT} | — | — | 15 | mA |
| | MOC3041 | — | — | 10 | |
| | MOC3042 | — | — | 5 | |
| | MOC3043 | — | — | — | |
| Holding Current, Either Direction | I _H | — | 100 | — | μA |
| Isolation Voltage (f = 60 Hz, t = 1 sec) | V _{ISO} | 7500 | — | — | Vac(pk) |

ZERO CROSSING

| | | | | | |
|--|-------------------|---|---|-----|-------|
| Inhibit Voltage (I _F = Rated I _{FT} , MT1-MT2 Voltage above which device will not trigger.) | V _{IH} | — | 5 | 20 | Volts |
| Leakage in Inhibited State (I _F = Rated I _{FT} , Rated V _{DRM} , Off State) | I _{DRM2} | — | — | 500 | μA |

Notes: 1. Test voltage must be applied within dv/dt rating.

2. All devices are guaranteed to trigger at an I_F value less than or equal to max I_{FT}. Therefore, recommended operating I_F lies between max I_{FT} (15 mA for MOC3041, 10 mA for MOC3042, 5 mA for MOC3043) and absolute max I_F (60 mA).

3. This is static dv/dt. See Figure 7 for test circuit. Commutating dv/dt is a function of the load-driving thyristor(s) only.

6

TYPICAL ELECTRICAL CHARACTERISTICS

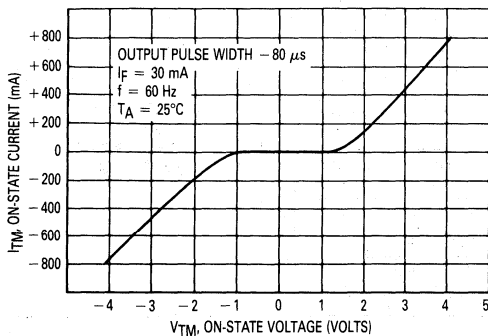

Figure 1. On-State Characteristics

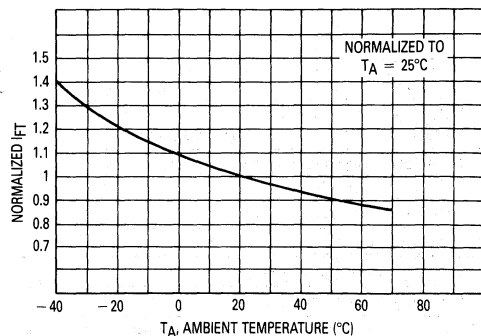

Figure 2. Trigger Current versus Temperature

MOC3041, MOC3042, MOC3043

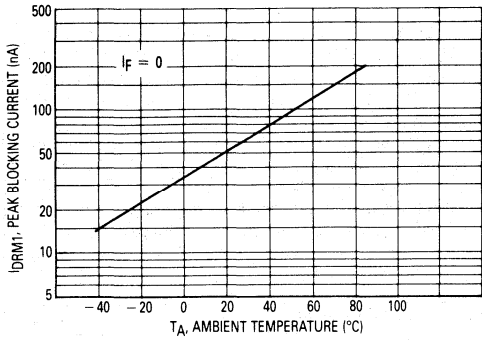

Figure 3. IDRM1, Peak Blocking Current versus Temperature

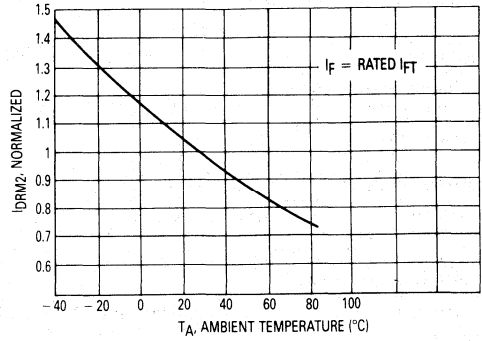

Figure 4. IDRM2, Leakage in Inhibit State versus Temperature

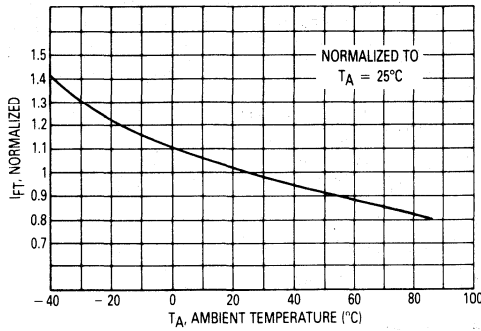

Figure 5. Trigger Current versus Temperature

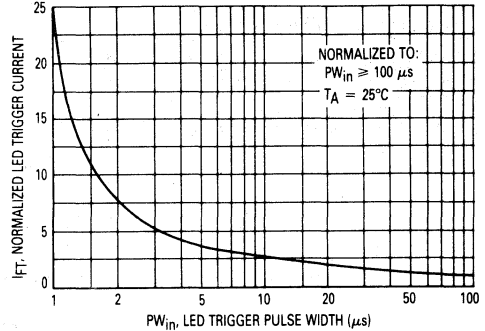

Figure 6. LED Current Required to Trigger versus LED Pulse Width

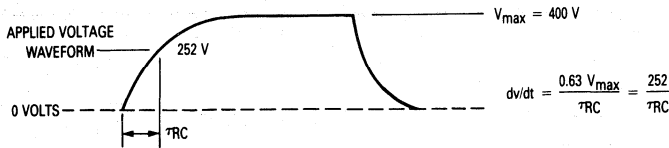
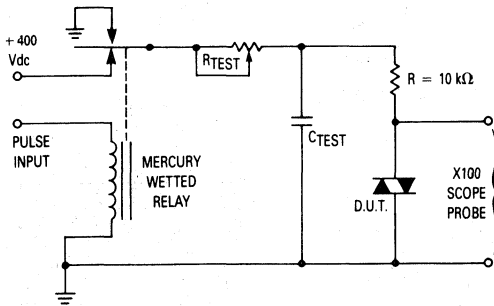
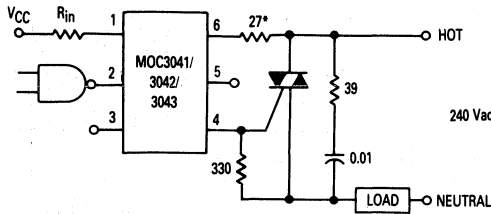

Figure 7. Static dv/dt Test Circuit

MOC3041, MOC3042, MOC3043



*For highly inductive loads (power factor < 0.5), change this value to 360 ohms.

Figure 8. Hot-Line Switching Application Circuit

Typical circuit for use when hot line switching is required. In this circuit the "hot" side of the line is switched and the load connected to the cold or neutral side. The load may be connected to either the neutral or hot line.

R_{in} is calculated so that I_F is equal to the rated I_{FT} of the part, 5 mA for the MOC3043, 10 mA for the MOC3042, or 15 mA for the MOC3041. The 39 ohm resistor and 0.01 μ F capacitor are for snubbing of the triac and may not be necessary depending upon the particular triac and load used.

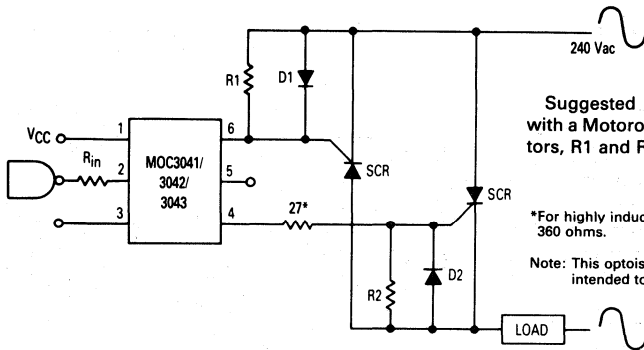

Suggested method of firing two, back-to-back SCR's, with a Motorola triac driver. Diodes can be 1N4001; resistors, R1 and R2, are optional 330 ohms.

*For highly inductive loads (power factor < 0.5), change this value to 360 ohms.

Note: This optoisolator should not be used to drive a load directly. It is intended to be a trigger device only.

Figure 9. Inverse-Parallel SCR Driver Circuit

OUTLINE DIMENSIONS

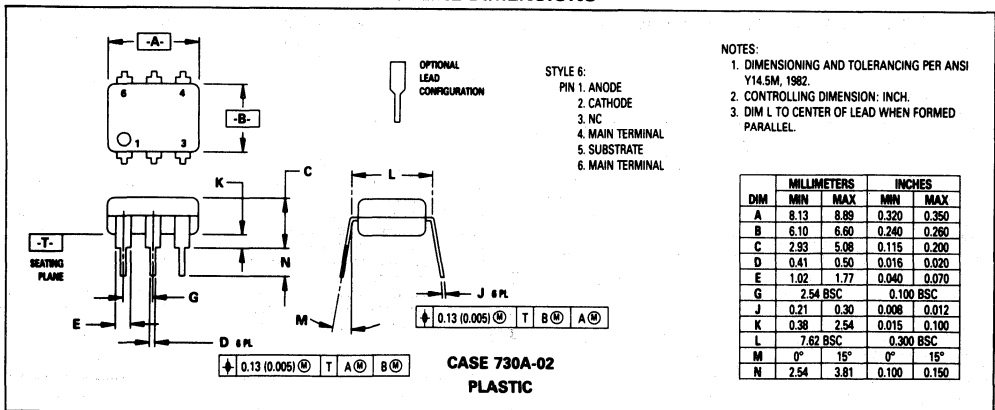



6

6-Pin DIP Optoisolators Triac Driver Output

These devices consist of gallium arsenide infrared emitting diodes optically coupled to monolithic silicon detectors performing the functions of Zero Voltage Crossing bilateral triac drivers.

They are designed for use with a triac in the interface of logic systems to equipment powered from 240 Vac lines, such as solid-state relays, industrial controls, motors, solenoids and consumer appliances, etc.

- Simplifies Logic Control of 240 Vac Power
- Zero Voltage Crossing
- High Breakdown Voltage: $V_{DRM} = 600$ V Min
- High Isolation Voltage: $V_{ISO} = 7500$ V Min
- Small, Economical, 6-Pin DIP Package
- Same Pin Configuration as MOC3041 Series
- UL Recognized, File No. E54915 
- dv/dt of 1500 V/ μ s Typ, 600 V/ μ s Guaranteed
- VDE approved per standard 0883/6.80 (Certificate number 41853), with additional approval to DIN IEC380/VDE0806, IEC435/VDE0805, IEC65/VDE0860, VDE0110b, covering all other standards with equal or less stringent requirements, including  883
- Special lead form available (add suffix "T" to part number) which satisfies VDE0883/6.80 requirement for 8 mm minimum creepage distance between input and output solder pads.
- Various lead form options available. Consult "Optoisolator Lead Form Options" data sheet for details.

MAXIMUM RATINGS

| Rating | Symbol | Value | Unit |
|--------|--------|-------|------|
|--------|--------|-------|------|

INFRARED EMITTING DIODE

| | | | |
|---|-------|------|----------------------|
| Reverse Voltage | V_R | 6 | Volts |
| Forward Current — Continuous | I_F | 60 | mA |
| Total Power Dissipation ($\alpha T_A = 25^\circ\text{C}$ Negligible Power in Output Driver Derate above 25°C) | P_D | 120 | mW |
| | | 1.41 | mW/ $^\circ\text{C}$ |

OUTPUT DRIVER

| | | | |
|--|-----------|------|----------------------|
| Off-State Output Terminal Voltage | V_{DRM} | 600 | Volts |
| Peak Repetitive Surge Current (PW = 100 μ s, 120 pps) | I_{TSM} | 1 | A |
| Total Power Dissipation ($\alpha T_A = 25^\circ\text{C}$ Derate above 25°C) | P_D | 150 | mW |
| | | 1.76 | mW/ $^\circ\text{C}$ |

TOTAL DEVICE

| | | | |
|---|-----------|-------------|----------------------|
| Isolation Surge Voltage (1) (Peak ac Voltage, 60 Hz, 1 Second Duration) | V_{ISO} | 7500 | Vac |
| Total Power Dissipation @ $T_A = 25^\circ\text{C}$ Derate above 25°C | P_D | 250 | mW |
| | | 2.94 | mW/ $^\circ\text{C}$ |
| Junction Temperature Range | T_J | -40 to +100 | $^\circ\text{C}$ |
| Ambient Operating Temperature Range | T_A | -40 to +85 | $^\circ\text{C}$ |
| Storage Temperature Range | T_{stg} | -40 to +150 | $^\circ\text{C}$ |
| Soldering Temperature (10 s) | — | 260 | $^\circ\text{C}$ |

(1) Isolation surge voltage, V_{ISO} , is an internal device dielectric breakdown rating. For this test, Pins 1 and 2 are common, and Pins 4, 5 and 6 are common.

MOC3061
MOC3062
MOC3063

6-PIN DIP
OPTOISOLATORS
TRIAC DRIVER OUTPUT
600 VOLTS

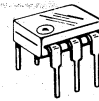

CASE 730A-02
PLASTIC

COUPLER SCHEMATIC

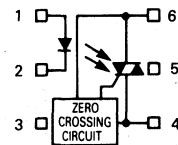

1. ANODE
2. CATHODE
3. NC
4. MAIN TERMINAL
5. SUBSTRATE
DO NOT CONNECT
6. MAIN TERMINAL

MOC3061, MOC3062, MOC3063

ELECTRICAL CHARACTERISTICS ($T_A = 25^\circ\text{C}$ unless otherwise noted)

| Characteristic | Symbol | Min | Typ | Max | Unit |
|--|------------|------|------|-------------------------------|------------------------|
| INPUT LED | | | | | |
| Reverse Leakage Current ($V_R = 6\text{ V}$) | I_R | — | 0.05 | 100 | μA |
| Forward Voltage ($I_F = 30\text{ mA}$) | V_F | — | 1.3 | 1.5 | Volts |
| OUTPUT DETECTOR ($I_F = 0$) | | | | | |
| Leakage with LED Off, Either Direction (Rated V_{DRM} , Note 1) | I_{DRM1} | — | 60 | 500 | nA |
| Critical Rate of Rise of Off-State Voltage (Note 3) | dv/dt | 600 | 1500 | — | $\text{V}/\mu\text{s}$ |
| COUPLED | | | | | |
| LED Trigger Current, Current Required to Latch Output (Main Terminal Voltage = 3 V, Note 2) | I_{FT} | — | — | 15 10 5 | mA |
| | | | | MOC3061 MOC3062 MOC3063 | |
| Peak On-State Voltage, Either Direction ($I_{TM} = 100\text{ mA}$, $I_F = \text{Rated } I_{FT}$) | V_{TM} | — | 1.8 | 3 | Volts |
| Holding Current, Either Direction | I_H | — | 100 | — | μA |
| Inhibit Voltage (MT1-MT2 Voltage above which device will not trigger.) ($I_F = \text{Rated } I_{FT}$) | V_{INH} | — | 5 | 20 | Volts |
| Leakage in Inhibited State ($I_F = \text{Rated } I_{FT}$, Rated V_{DRM} , Off State) | I_{DRM2} | — | — | 500 | μA |
| Isolation Voltage ($f = 60\text{ Hz}$, $t = 1\text{ sec}$) | V_{ISO} | 7500 | — | — | Vac(pk) |

- Notes: 1. Test voltage must be applied within dv/dt rating.
 2. All devices are guaranteed to trigger at an I_F value less than or equal to max I_{FT} . Therefore, recommended operating I_F lies between max I_{FT} (15 mA for MOC3061, 10 mA for MOC3062, 5 mA for MOC3063) and absolute max I_F (60 mA).
 3. This is static dv/dt . See Figure 7 for test circuit. Commutating dv/dt is a function of the load-driving thyristor(s) only.

6

TYPICAL CHARACTERISTICS

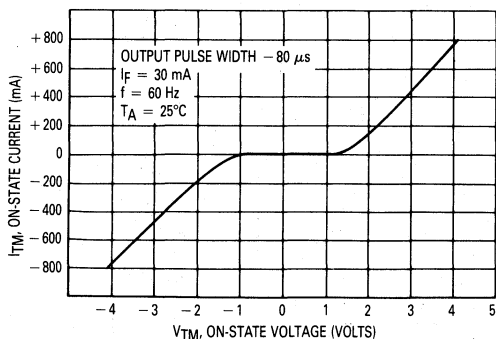

Figure 1. On-State Characteristics

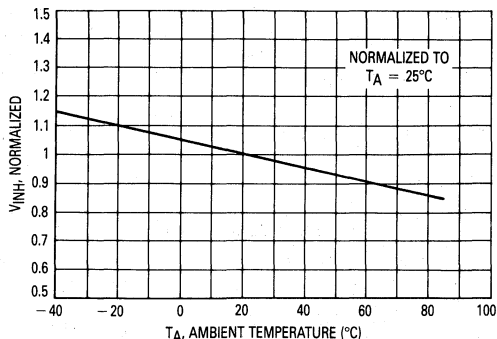

Figure 2. Inhibit Voltage versus Temperature

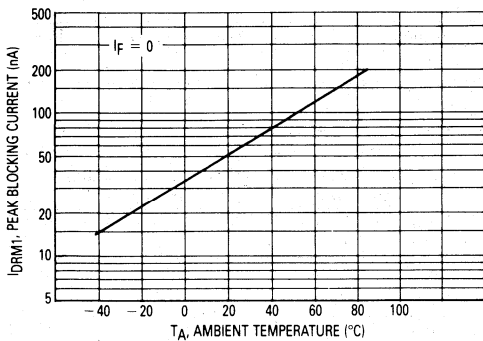

Figure 3. Leakage with LED Off versus Temperature

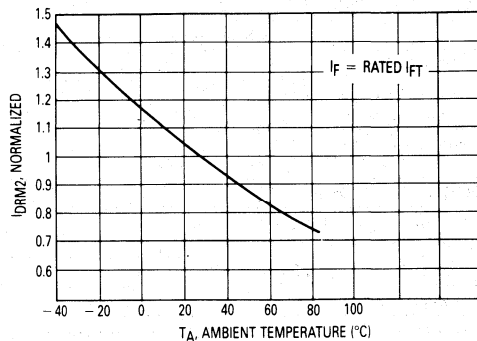

Figure 4. IdRM2, Leakage in Inhibit State versus Temperature

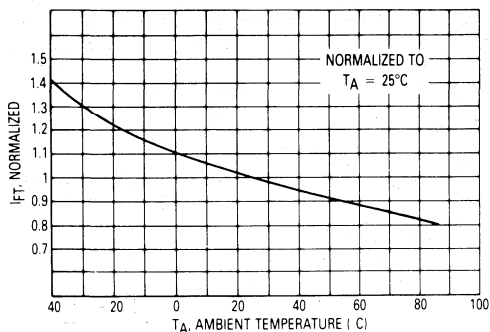

Figure 5. Trigger Current versus Temperature

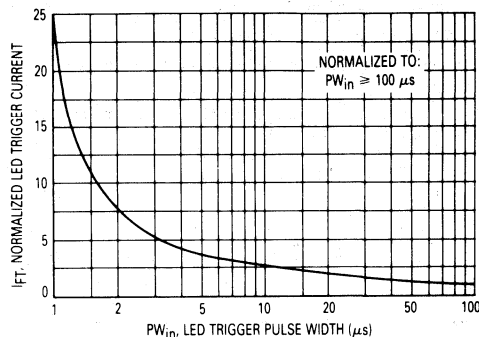

Figure 6. LED Current Required to Trigger versus LED Pulse Width

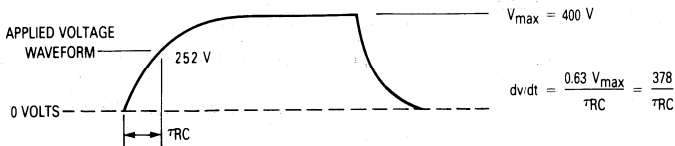
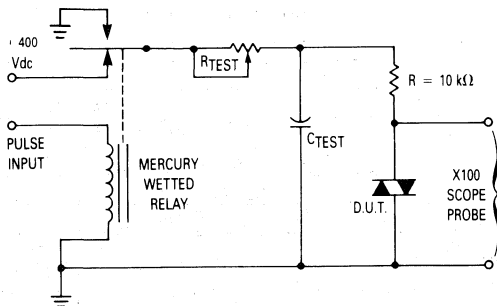
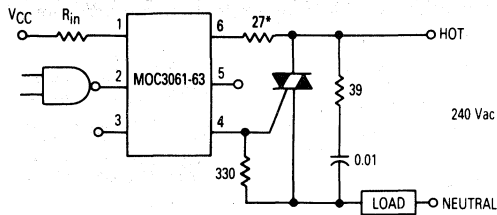

Figure 7. Static dv/dt Test Circuit

1. The mercury wetted relay provides a high speed repeated pulse to the D.U.T.
2. 100x scope probes are used, to allow high speeds and voltages.
3. The worst-case condition for static dv/dt is established by triggering the D.U.T. with a normal LED input current, then removing the current. The variable RTEST allows the dv/dt to be gradually increased until the D.U.T. continues to trigger in response to the applied voltage pulse, even after the LED current has been removed. The dv/dt is then decreased until the D.U.T. stops triggering. τRC is measured at this point and recorded.

MOC3061, MOC3062, MOC3063



Typical circuit for use when hot line switching is required. In this circuit the "hot" side of the line is switched and the load connected to the cold or neutral side. The load may be connected to either the neutral or hot line.

R_{in} is calculated so that I_F is equal to the rated I_{FT} of the part, 15 mA for the MOC3061, 10 mA for the MOC3062, and 5 mA for the MOC3063. The 39 ohm resistor and 0.01 μF capacitor are for snubbing of the triac and may or may not be necessary depending upon the particular triac and load used.

Figure 8. Hot-Line Switching Application Circuit

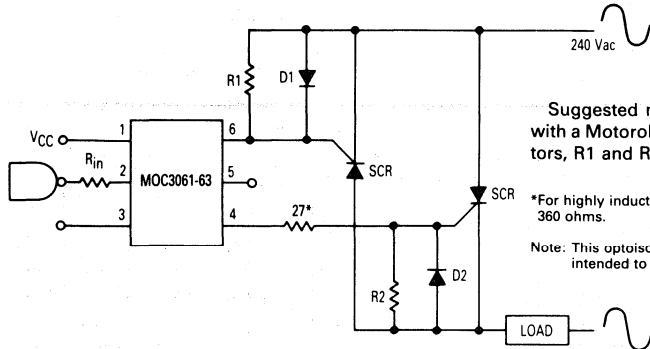

Suggested method of firing two, back-to-back SCR's, with a Motorola triac driver. Diodes can be 1N4001; resistors, R1 and R2, are optional 330 ohms.

*For highly inductive loads (power factor < 0.5), change this value to 360 ohms.

Note: This optoisolator should not be used to drive a load directly. It is intended to be a trigger device only.

Figure 9. Inverse-Parallel SCR Driver Circuit

OUTLINE DIMENSIONS

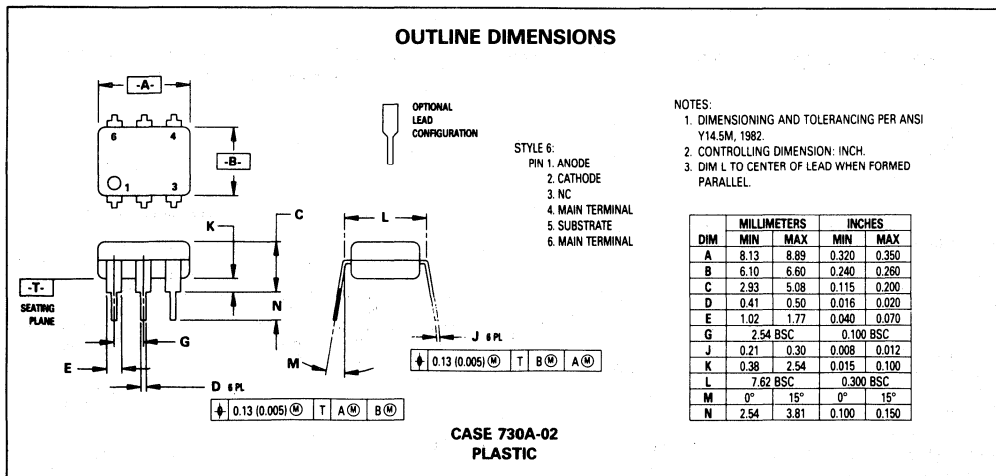

6-Pin DIP Optoisolators Triac Driver Output

These devices consist of gallium arsenide infrared emitting diodes optically coupled to monolithic silicon detectors performing the functions of Zero Voltage Crossing bilateral triac drivers.

They are designed for use with a triac in the interface of logic systems to equipment powered from 240 Vac lines, such as solid-state relays, industrial controls, motors, solenoids and consumer appliances, etc.

- Simplifies Logic Control of 240 Vac Power
- Zero Voltage Crossing
- High Breakdown Voltage: $V_{DRM} = 800$ V Min
- High Isolation Voltage: $V_{ISO} = 7500$ V Min
- Small, Economical, 6-Pin DIP Package
- Same Pin Configuration as MOC3031/3041/3061 Series
- UL Recognized, File No. E54915
- dv/dt of 1500 V/ μ s Typ, 600 V/ μ s Guaranteed
- VDE approved per standard 0883/6.80 (Certificate number 41853), with additional approval to DIN IEC380/VDE0806, IEC435/VDE0805, IEC65/VDE0860, VDE110b, covering all other standards with equal or less stringent requirements, including IEC204/VDE0113, VDE0160, VDE0832, VDE0833, etc. 
- Special lead form available (add suffix "T" to part number) which satisfies VDE0883/6.80 requirement for 8 mm minimum creepage distance between input and output solder pads
- Various lead form options available. Consult "Optoisolator Lead Form Options" data sheet for details

MAXIMUM RATINGS

| Rating | Symbol | Value | Unit |
|--------|--------|-------|------|
|--------|--------|-------|------|

INPUT LED

| | | | |
|---|-------|------|-------|
| Reverse Voltage | V_R | 6 | Volts |
| Forward Current — Continuous | I_F | 60 | mA |
| Total Power Dissipation ($\theta_{TA} = 25^\circ\text{C}$ Negligible Power in Output Driver Derate above 25°C) | P_D | 120 | mW |
| | | 1.41 | mW/°C |

OUTPUT DRIVER

| | | | |
|--|-----------|------|-------|
| Off-State Output Terminal Voltage | V_{DRM} | 800 | Volts |
| Peak Repetitive Surge Current ($PW = 100 \mu\text{s}$, 120 pps) | I_{TSM} | 1 | A |
| Total Power Dissipation ($\theta_{TA} = 25^\circ\text{C}$ Derate above 25°C) | P_D | 150 | mW |
| | | 1.76 | mW/°C |

TOTAL DEVICE

| | | | |
|--|-----------|------|-------|
| Isolation Surge Voltage (1) (Peak ac Voltage, 60 Hz, 1 Second Duration) | V_{ISO} | 7500 | Vac |
| Total Power Dissipation ($\theta_{TA} = 25^\circ\text{C}$ Derate above 25°C) | P_D | 250 | mW |
| | | 2.94 | mW/°C |

(1) Isolation surge voltage, V_{ISO} , is an internal device dielectric breakdown rating.
 For this test, Pins 1 and 2 are common, and Pins 4; 5 and 6 are common.

(continued)

MOC3081
MOC3082
MOC3083

OPTOISOLATORS
ZERO CROSSING
TRIAC DRIVERS
800 VOLTS

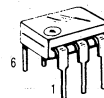

CASE 730A-02
PLASTIC

COUPLER SCHEMATIC

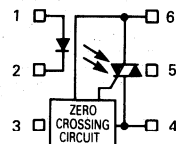

1. ANODE
2. CATHODE
3. NC
4. MAIN TERMINAL
5. SUBSTRATE
DO NOT CONNECT
6. MAIN TERMINAL

8LT 20FR → 1.50. 1.26
 02-T 20FR. 1.40
 03-T 20FR. 2.05

MOC3081, MOC3082, MOC3083

MAXIMUM RATINGS — continued

| Rating | Symbol | Value | Unit |
|-------------------------------------|-----------|-------------|------|
| TOTAL DEVICE — continued | | | |
| Junction Temperature Range | T_J | -40 to +100 | °C |
| Ambient Operating Temperature Range | T_A | -40 to +85 | °C |
| Storage Temperature Range | T_{stg} | -40 to +150 | °C |
| Soldering Temperature (10 s) | — | 260 | °C |

ELECTRICAL CHARACTERISTICS ($T_A = 25^\circ\text{C}$ unless otherwise noted)

| Characteristic | Symbol | Min | Typ | Max | Unit |
|----------------|--------|-----|-----|-----|------|
|----------------|--------|-----|-----|-----|------|

INPUT LED

| | | | | | |
|--|-------|---|------|-----|---------------|
| Reverse Leakage Current ($V_R = 6\text{ V}$) | I_R | — | 0.05 | 100 | μA |
| Forward Voltage ($I_F = 30\text{ mA}$) | V_F | — | 1.3 | 1.5 | Volts |

OUTPUT DETECTOR ($I_F = 0$)

| | | | | | |
|---|------------|-----|------|-----|------------------------|
| Leakage with LED Off, Either Direction ($V_{DRM} = 800\text{ V}$, Note 1) | I_{DRM1} | — | 80 | 500 | nA |
| Critical Rate of Rise of Off-State Voltage (Note 3) | dv/dt | 600 | 1500 | — | $\text{V}/\mu\text{s}$ |

COUPLED

| | | | | | |
|---|------------|---|-----|-----|---------------|
| LED Trigger Current, Current Required to Latch Output (Main Terminal Voltage = 3 V, Note 2) | I_{FT} | — | — | 15 | mA |
| | MOC3081 | — | — | 10 | |
| | MOC3082 | — | — | 5 | |
| | MOC3083 | — | — | — | |
| Peak On-State Voltage, Either Direction ($I_{TM} = 100\text{ mA}$, $I_F = \text{Rated } I_{FT}$) | V_{TM} | — | 1.8 | 3 | Volts |
| Holding Current, Either Direction | I_H | — | 100 | — | μA |
| Inhibit Voltage (MT1-MT2 Voltage above which device will not trigger) ($I_F = \text{Rated } I_{FT}$) | V_{INH} | — | 5 | 20 | Volts |
| Leakage in Inhibited State ($I_F = \text{Rated } I_{FT}$, $V_{DRM} = 800\text{ V}$, Off State) | I_{DRM2} | — | 300 | 500 | μA |

Notes: 1. Test voltage must be applied within dv/dt rating.

2. All devices are guaranteed to trigger at an I_F value less than or equal to max I_{FT} . Therefore, recommended operating I_F lies between max I_{FT} (15 mA for MOC3081, 10 mA for MOC3082, 5 mA for MOC3083) and absolute max I_F (60 mA).

3. This is static dv/dt . See Figure 7 for test circuit. Commutating dv/dt is a function of the load-driving thyristor(s) only.

TYPICAL CHARACTERISTICS

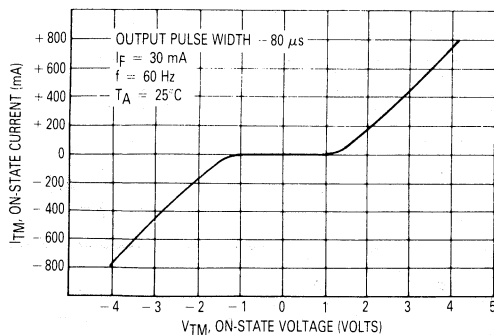

Figure 1. On-State Characteristics

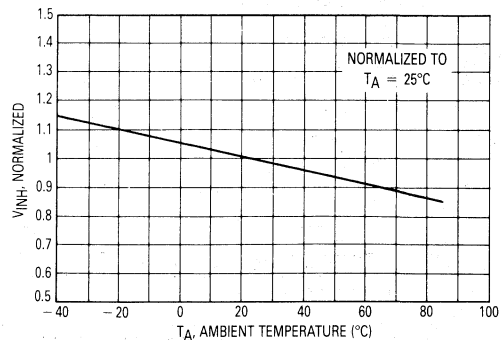

Figure 2. Inhibit Voltage versus Temperature

MOC3081, MOC3082, MOC3083

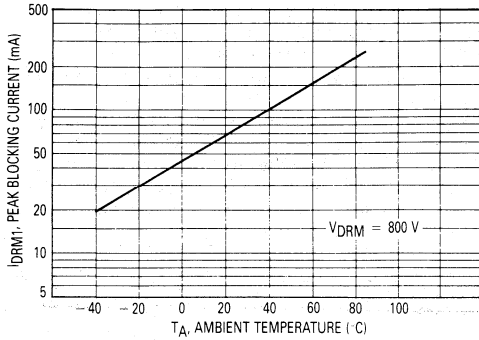

Figure 3. Leakage with LED Off versus Temperature

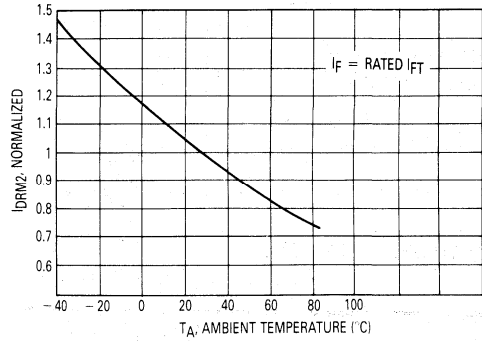

Figure 4. IDRM2, Leakage in Inhibit State versus Temperature

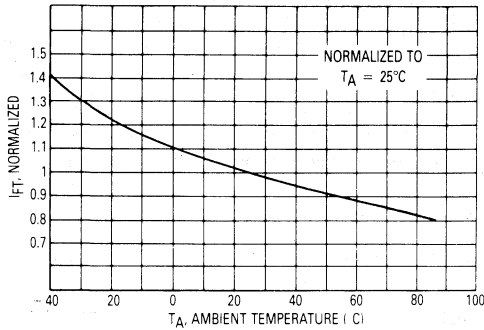

Figure 5. Trigger Current versus Temperature

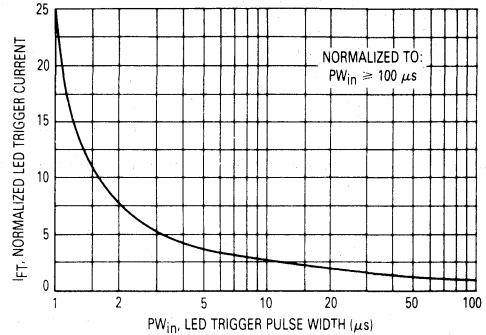

Figure 6. LED Current Required to Trigger versus LED Pulse Width

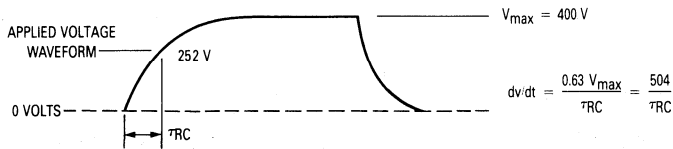
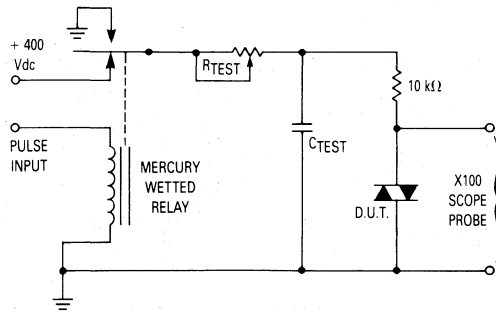
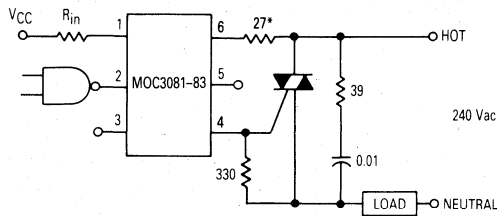

Figure 7. Static dv/dt Test Circuit

MOC3081, MOC3082, MOC3083



*For highly inductive loads (power factor < 0.5), change this value to 360 ohms.

Figure 8. Hot-Line Switching Application Circuit

Typical circuit for use when hot line switching is required. In this circuit the "hot" side of the line is switched and the load connected to the cold or neutral side. The load may be connected to either the neutral or hot line.

R_{in} is calculated so that I_F is equal to the rated I_{FT} of the part, 15 mA for the MOC3081, 10 mA for the MOC3082, and 5 mA for the MOC3083. The 39 ohm resistor and 0.01 μF capacitor are for snubbing of the triac and may or may not be necessary depending upon the particular triac and load used.

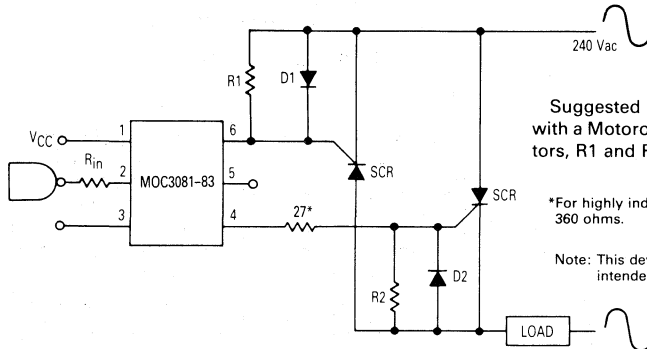

Suggested method of firing two, back-to-back SCR's, with a Motorola triac driver. Diodes can be 1N4001; resistors, R1 and R2, are optional 330 ohms.

*For highly inductive loads (power factor < 0.5), change this value to 360 ohms.

Note: This device should not be used to drive a load directly. It is intended to be a trigger device only.

Figure 9. Inverse-Parallel SCR Driver Circuit

OUTLINE DIMENSIONS

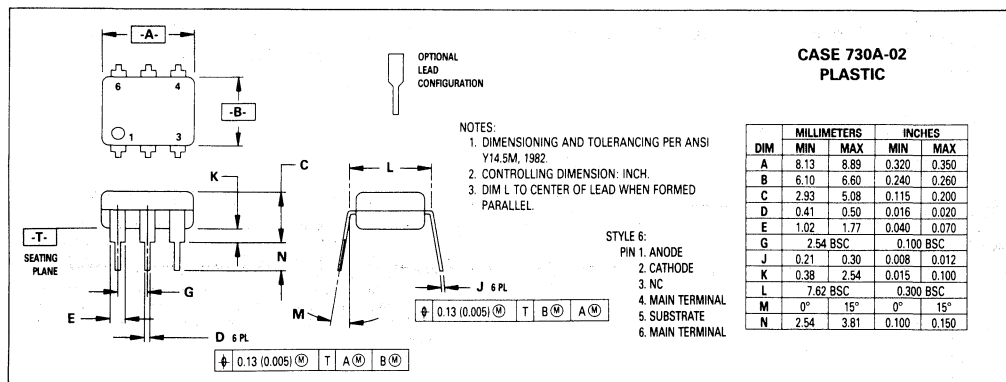

6

6-Pin DIP Optoisolators Logic Output

... gallium arsenide IRED optically coupled to a high-speed integrated detector with Schmitt trigger output. Designed for applications requiring electrical isolation, fast response time, noise immunity and digital logic compatibility such as interfacing computer terminals to peripheral equipment, digital control of power supplies, motors and other servo machine applications.

- High Isolation Voltage — $V_{ISO} = 7500 \text{ Vac(pk) Min}$
- Guaranteed Switching Times — $t_{on}, t_{off} < 4 \mu\text{s}$
- Built-In ON/OFF Threshold Hysteresis
- Economical, Standard Dual-In-Line Plastic Package
- UL Recognized, File No. E54915

MOC5007
MOC5008
MOC5009

6-PIN DIP
OPTOISOLATORS
LOGIC OUTPUT

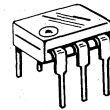

CASE 730A-02
PLASTIC

MAXIMUM RATINGS ($T_A = 25^\circ\text{C}$ unless otherwise noted)

| Rating | Symbol | Value | Unit |
|--------|--------|-------|------|
|--------|--------|-------|------|

INPUT LED

| | | | |
|---|-------|-------------|----------------------------|
| Reverse Voltage | V_R | 6 | Volts |
| Forward Current — Continuous Peak Pulse Width = 300 μs , 2% Duty Cycle | I_F | 60 1.2 | mA Amp |
| LED Power Dissipation @ $T_A = 25^\circ\text{C}$ Derate above 25°C | P_D | 120 1.41 | mW mW/ $^\circ\text{C}$ |

OUTPUT DETECTOR

| | | | |
|--|----------|-------------|----------------------------|
| Output Voltage Range | V_O | 0–16 | Volts |
| Supply Voltage Range | V_{CC} | 3–16 | Volts |
| Output Current | I_O | 50 | mA |
| Detector Power Dissipation @ $T_A = 25^\circ\text{C}$ Derate above 25°C | P_D | 150 1.76 | mW mW/ $^\circ\text{C}$ |

TOTAL DEVICE

| | | | |
|--|-----------|-------------|----------------------------|
| Total Device Power Dissipation @ $T_A = 25^\circ\text{C}$ Derate above 25°C | P_D | 250 2.94 | mW mW/ $^\circ\text{C}$ |
| Maximum Operating Temperature | T_A | -40 to +85 | $^\circ\text{C}$ |
| Storage Temperature Range | T_{stg} | -55 to +150 | $^\circ\text{C}$ |
| Soldering Temperature (10 s) | | 260 | $^\circ\text{C}$ |
| Isolation Surge Voltage (Pk ac Voltage, 60 Hz, 1 Second Duration) (1) | V_{ISO} | 7500 | Volts |

(1) Isolation surge voltage is an internal device dielectric breakdown rating.

MOC5007, MOC5008, MOC5009

ELECTRICAL CHARACTERISTICS (T_A = 0 to 70°C)

| Characteristic | Symbol | Min | Typ | Max | Unit | |
|---|--|------------------|-------------|-----|---------|----|
| INPUT LED | | | | | | |
| Reverse Leakage Current (V _R = 3 V, R _L = 1 MΩ) | I _R | — | 0.05 | 10 | μA | |
| Forward Voltage (I _F = 10 mA) (I _F = 0.3 mA) | V _F | — 0.75 | 1.2 0.95 | 1.5 | Volts | |
| Capacitance (V _R = 0 V, f = 1 MHz) | C | — | 18 | — | pF | |
| OUTPUT DETECTOR | | | | | | |
| Operating Voltage | V _{CC} | 3 | — | 15 | Volts | |
| Supply Current (I _F = 0, V _{CC} = 5 V) | I _{CC(off)} | — | 1 | 5 | mA | |
| Output Current, High (I _F = 0, V _{CC} = V _O = 15 V) | I _{OH} | — | — | 100 | μA | |
| COUPLED | | | | | | |
| Supply Current (I _F = I _{F(on)} , V _{CC} = 5 V) | I _{CC(on)} | — | 1.6 | 5 | mA | |
| Output Voltage, Low (R _L = 270 Ω, V _{CC} = 5 V, I _F = I _{F(on)}) | V _{OL} | — | 0.2 | 0.4 | Volts | |
| Threshold Current, ON (R _L = 270 Ω, V _{CC} = 5 V) | I _{F(on)} | — | 1 | 1.6 | mA | |
| | MOC5007 | — | — | 4 | | |
| | MOC5008, 5009 | — | — | 10 | | |
| Threshold Current, OFF (R _L = 270 Ω, V _{CC} = 5 V) | I _{F(off)} | 0.3 | 0.75 | — | mA | |
| | MOC5007 | 0.3 | — | — | | |
| | MOC5008, 5009 | — | — | — | | |
| Hysteresis Ratio (R _L = 270 Ω, V _{CC} = 5 V) | I _{F(off)} / I _{F(on)} | 0.5 | 0.75 | 0.9 | | |
| Isolation Voltage (1) 60 Hz, AC Peak, 1 second, T _A = 25°C | V _{ISO} | 7500 | — | — | Vac(pk) | |
| Turn-On Time | R _L = 270 Ω V _{CC} = 5 V, I _F = I _{F(on)} T _A = 25°C | t _{on} | — | 1.2 | 4 | μs |
| Fall Time | | t _f | — | 0.1 | — | |
| Turn-Off Time | | t _{off} | — | 1.2 | 4 | |
| Rise Time | | t _r | — | 0.1 | — | |

(1) For this test IRED Pins 1 and 2 are common and Output Gate Pins 4, 5, 6 are common.

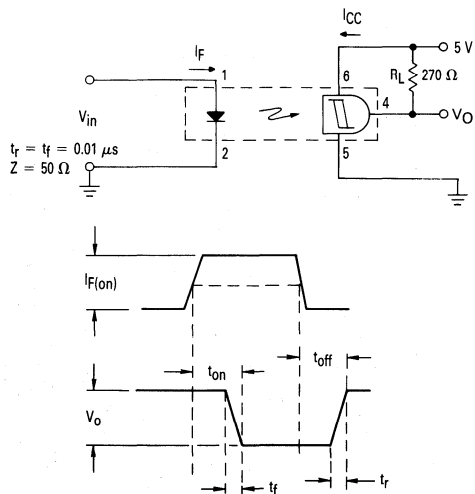
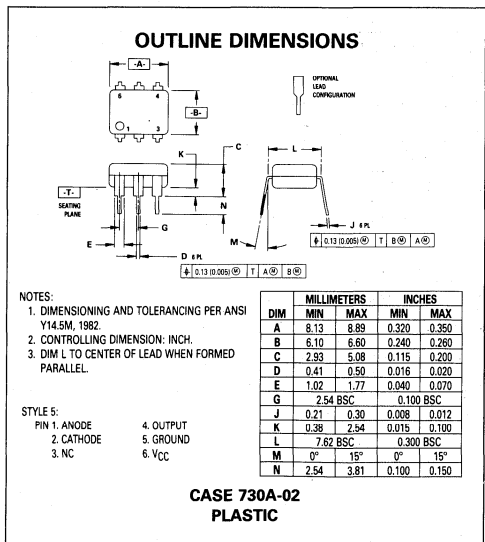

Figure 1. Switching Test Circuit



MOC5007, MOC5008, MOC5009

TYPICAL CHARACTERISTICS

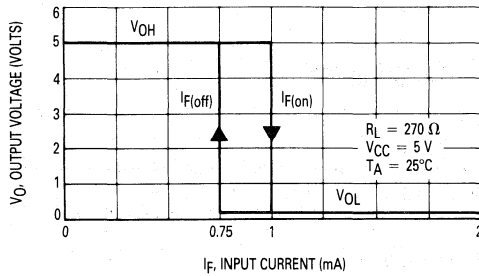

Figure 2. Transfer Characteristics for MOC5007

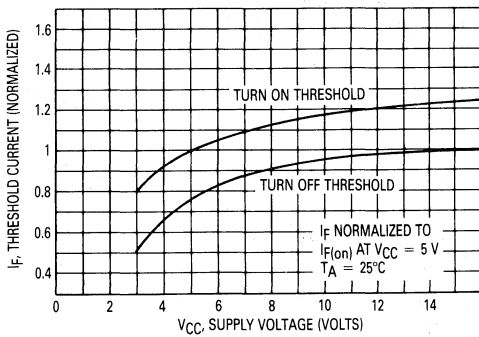

Figure 3. Threshold Current versus Supply Voltage

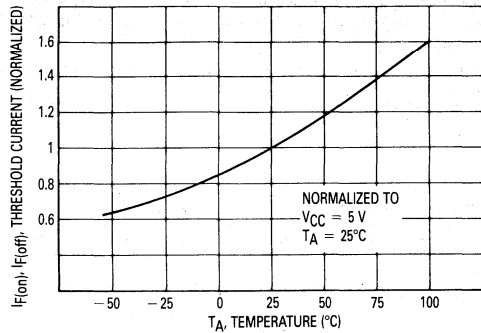

Figure 4. Threshold Current versus Temperature

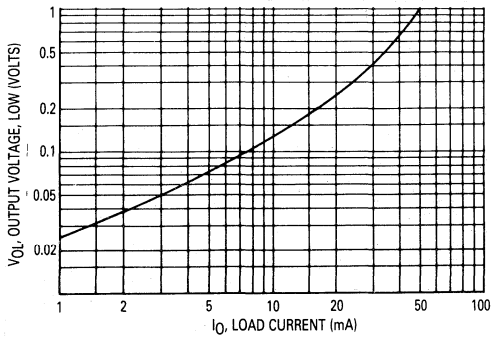

Figure 5. Output Voltage, Low versus Load Current

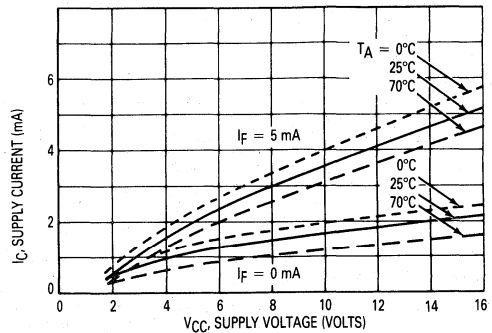



Figure 6. Supply Current versus Supply Voltage

6-Pin DIP Optoisolators Darlington Output

Each device consists of a gallium arsenide infrared emitting diode optically coupled to a monolithic silicon photodarlington detector.

They are designed for use in applications requiring high sensitivity at low input currents.

- Convenient Plastic Dual-In-Line Package
- High Sensitivity to Low Input Drive Current
- High Input-Output Isolation Guaranteed — 7500 Volts Peak
- UL Recognized. File Number E54915 
- VDE approved per standard 0883/6.80 (Certificate number 41853), with additional approval to DIN IEC380/VDE0806, IEC435/VDE0805, IEC65/VDE0860, VDE0110b, covering all other standards with equal or less stringent requirements, including IEC204/VDE0113, VDE0160, VDE0832, VDE0833, etc. 
- Special lead form available (add suffix "T" to part number) which satisfies VDE0883/6.80 requirement for 8 mm minimum creepage distance between input and output solder pads.
- Various lead form options available. Consult "Optoisolator Lead Form Options" data sheet for details.

MOC8020
MOC8021

**6-PIN DIP
 OPTOISOLATORS
 DARLINGTON
 OUTPUT**

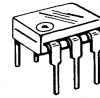

**CASE 730A-02
 PLASTIC**

MAXIMUM RATINGS ($T_A = 25^\circ\text{C}$ unless otherwise noted)

| Rating | Symbol | Value | Unit |
|--------|--------|-------|------|
|--------|--------|-------|------|

INPUT LED

| | | | |
|---|-------|------|----------------------|
| Reverse Voltage | V_R | 3 | Volts |
| Forward Current — Continuous | I_F | 60 | mA |
| LED Power Dissipation @ $T_A = 25^\circ\text{C}$ with Negligible Power in Output Detector Derate above 25°C | P_D | 120 | mW |
| | | 1.41 | mW/ $^\circ\text{C}$ |

OUTPUT DETECTOR

| | | | |
|--|-----------|------|----------------------|
| Collector-Emitter Voltage | V_{CE0} | 50 | Volts |
| Emitter-Collector Voltage | V_{EC0} | 5 | Volts |
| Detector Power Dissipation @ $T_A = 25^\circ\text{C}$ with Negligible Power in Input LED Derate above 25°C | P_D | 150 | mW |
| | | 1.76 | mW/ $^\circ\text{C}$ |

TOTAL DEVICE

| | | | |
|--|-----------|-------------|----------------------|
| Isolation Surge Voltage (1) (Peak ac Voltage, 60 Hz, 1 sec Duration) | V_{ISO} | 7500 | Vac |
| Total Device Power Dissipation @ $T_A = 25^\circ\text{C}$ Derate above 25°C | P_D | 250 | mW |
| | | 2.94 | mW/ $^\circ\text{C}$ |
| Ambient Operating Temperature Range | T_A | -55 to +100 | $^\circ\text{C}$ |
| Storage Temperature Range | T_{stg} | -55 to +150 | $^\circ\text{C}$ |
| Soldering Temperature (10 seconds, 1/16" from case) | — | 260 | $^\circ\text{C}$ |

(1) Isolation surge voltage is an internal device dielectric breakdown rating. For this test, Pins 1 and 2 are common, and Pins 4, 5 and 6 are common.

SCHEMATIC

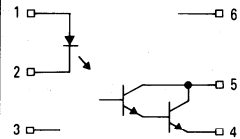

1. LED ANODE
2. LED CATHODE
3. N.C.
4. EMITTER
5. COLLECTOR
6. N.C.

MOC8020, MOC8021

ELECTRICAL CHARACTERISTICS (T_A = 25°C unless otherwise noted)

| Characteristic | Symbol | Min | Typ | Max | Unit |
|----------------|--------|-----|-----|-----|------|
|----------------|--------|-----|-----|-----|------|

INPUT LED

| | | | | | |
|---|----------------|---|------|----|-------|
| Reverse Leakage Current (V _R = 3 V) | I _R | — | 0.05 | 10 | μA |
| Forward Voltage (I _F = 10 mA) | V _F | — | 1.15 | 2 | Volts |
| Capacitance (V _R = 0 V, f = 1 MHz) | C | — | 18 | — | pF |

PHOTODARLINGTON (T_A = 25°C and I_F = 0, unless otherwise noted)

| | | | | | |
|--|----------------------|----|---|-----|-------|
| Collector-Emitter Dark Current (V _{CE} = 10 V) | I _{CEO} | — | — | 100 | nA |
| Collector-Emitter Breakdown Voltage (I _C = 1 mA) | V _{(BR)CEO} | 50 | — | — | Volts |
| Emitter-Collector Breakdown Voltage (I _E = 100 μA) | V _{(BR)ECO} | 5 | — | — | Volts |

COUPLED (T_A = 25°C unless otherwise noted)

| | | | | | |
|---|------------------|-----------|------------------|--------|-------|
| Collector Output Current (V _{CE} = 5 V, I _F = 10 mA) | I _C | 50 100 | — — | — — | mA |
| Isolation Surge Voltage (1, 2), 60 Hz Peak ac, 1 Second | V _{ISO} | 7500 | — | — | Volts |
| Isolation Resistance (1) (V = 500 V) | R _{ISO} | — | 10 ¹¹ | — | Ohms |
| Isolation Capacitance (1) (V = 0, f = 1 MHz) | C _{ISO} | — | 0.2 | — | pF |

SWITCHING

| | | | | | | |
|---------------|---|------------------|---|-----|---|----|
| Turn-On Time | V _{CC} = 10 V, R _L = 100 Ω, I _F = 5 mA | t _{on} | — | 3.5 | — | μs |
| Turn-Off Time | | t _{off} | — | 95 | — | |
| Rise Time | | t _r | — | 1 | — | |
| Fall Time | | t _f | — | 2 | — | |

- (1) For this test LED Pins 1 and 2 are common and Phototransistor Pins 4 and 5 are common.
 (2) Isolation Surge Voltage, V_{ISO}, is an internal device dielectric breakdown rating.

6

TYPICAL CHARACTERISTICS

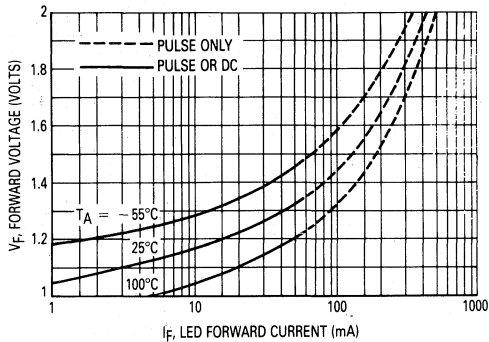

Figure 1. LED Forward Voltage versus Forward Current

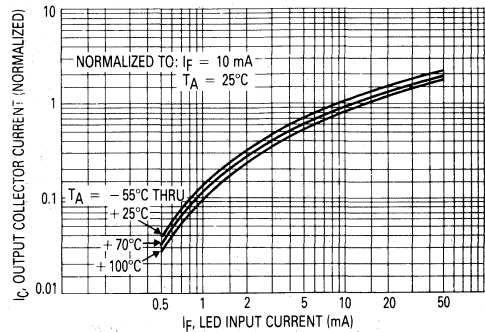

Figure 2. Output Current versus Input Current

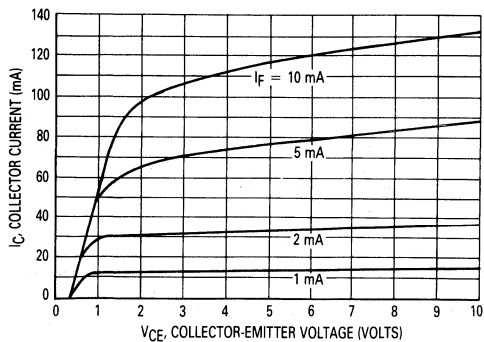

Figure 3. Collector Current versus Collector-Emitter Voltage

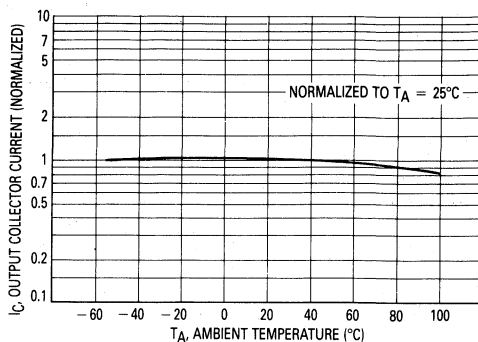

Figure 4. Output Current versus Ambient Temperature

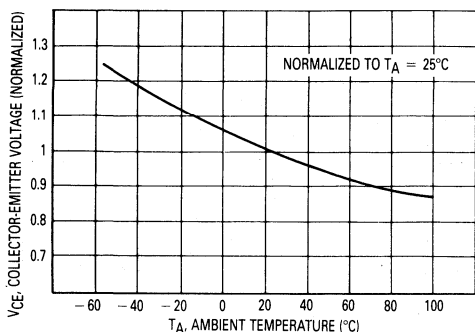

Figure 5. Collector-Emitter Voltage versus Ambient Temperature

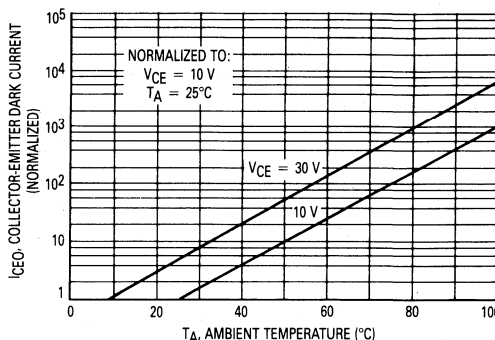

Figure 6. Collector-Emitter Dark Current versus Ambient Temperature

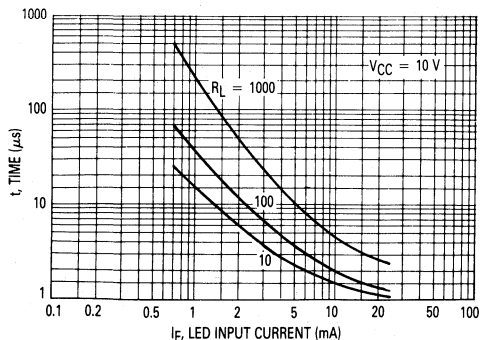

Figure 7. Turn-On Switching Times

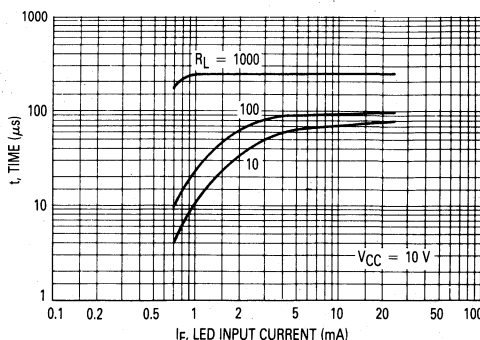

Figure 8. Turn-Off Switching Times

MOC8020, MOC8021

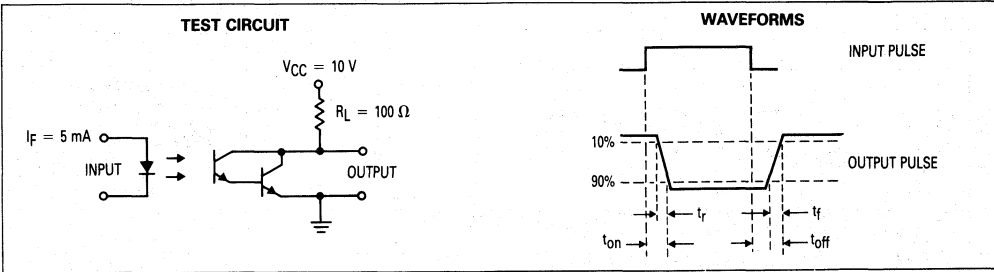
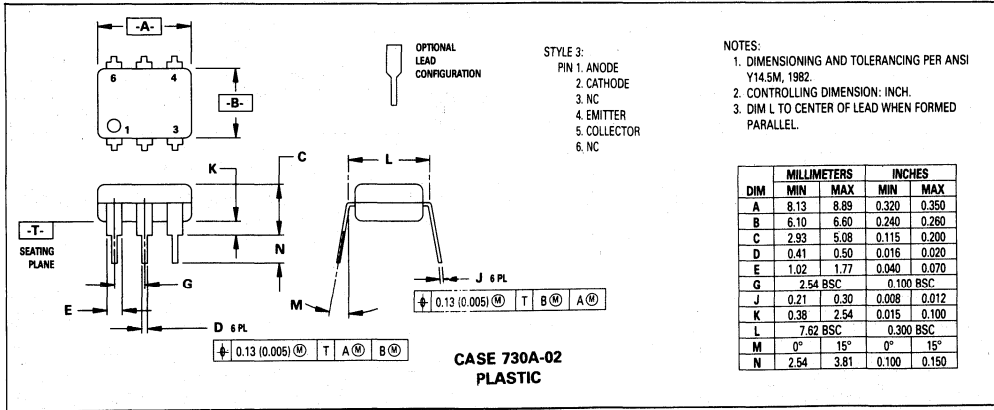

Figure 9. Switching Times



OUTLINE DIMENSIONS



6-Pin DIP Optoisolators Darlingtion Output

These devices consist of gallium arsenide infrared emitting diodes optically coupled to monolithic silicon photodarlington detectors.

They are designed for use in applications requiring high sensitivity at low input currents.

- Convenient Plastic Dual-In-Line Package
- High Sensitivity to Low Input Drive Current
- High Collector-Emitter Breakdown Voltage — 80 Volts Minimum
- High Input-Output Isolation Guaranteed — 7500 Volts Peak
- UL Recognized. File Number E54915 
- VDE approved per standard 0883/6.80 (Certificate number 41853), with additional approval to DIN IEC380/VDE0806, IEC435/VDE0805, IEC65/VDE0860, VDE0110b, covering all other standards with equal or less stringent requirements, including IEC204/VDE0113, VDE0160, VDE0832, VDE0833, etc. 
- Special lead form available (add suffix "T" to part number) which satisfies VDE0883/6.80 requirement for 8 mm minimum creepage distance between input and output solder pads.
- Various lead form options available. Consult "Optoisolator Lead Form Options" data sheet for details.

MOC8030
MOC8050

6-PIN DIP
OPTOISOLATORS
DARLINGTON
OUTPUT

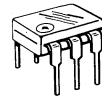

CASE 730A-02
PLASTIC

MAXIMUM RATINGS ($T_A = 25^\circ\text{C}$ unless otherwise noted)

| Rating | Symbol | Value | Unit |
|--------|--------|-------|------|
|--------|--------|-------|------|

INPUT LED

| | | | |
|---|-------|------|----------------------|
| Reverse Voltage | V_R | 3 | Volts |
| Forward Current — Continuous | I_F | 60 | mA |
| LED Power Dissipation @ $T_A = 25^\circ\text{C}$ with Negligible Power in Output Detector Derate above 25°C | P_D | 120 | mW |
| | | 1.41 | mW/ $^\circ\text{C}$ |

OUTPUT DETECTOR

| | | | |
|--|-----------|------|----------------------|
| Collector-Emitter Voltage | V_{CEO} | 80 | Volts |
| Emitter-Collector Voltage | V_{ECO} | 5 | Volts |
| Detector Power Dissipation @ $T_A = 25^\circ\text{C}$ with Negligible Power in Input LED Derate above 25°C | P_D | 150 | mW |
| | | 1.76 | mW/ $^\circ\text{C}$ |

TOTAL DEVICE

| | | | |
|--|-----------|-------------|----------------------------|
| Isolation Surge Voltage (1) (Peak ac Voltage, 60 Hz, 1 sec Duration) | V_{ISO} | 7500 | Vac |
| Total Device Power Dissipation @ $T_A = 25^\circ\text{C}$ Derate above 25°C | P_D | 250 2.94 | mW mW/ $^\circ\text{C}$ |
| Ambient Operating Temperature Range | T_A | -55 to +100 | $^\circ\text{C}$ |
| Storage Temperature Range | T_{stg} | -55 to +150 | $^\circ\text{C}$ |
| Soldering Temperature (10 seconds, 1/16" from case) | — | 260 | $^\circ\text{C}$ |

(1) Isolation surge voltage is an internal device dielectric breakdown rating. For this test, Pins 1 and 2 are common, and Pins 4, 5 and 6 are common.

SCHEMATIC

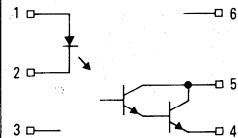

1. LED ANODE
2. LED CATHODE
3. N.C.
4. EMITTER
5. COLLECTOR
6. N.C.

MOC8030, MOC8050

ELECTRICAL CHARACTERISTICS ($T_A = 25^\circ\text{C}$ unless otherwise noted)

| Characteristic | Symbol | Min | Typ | Max | Unit |
|----------------|--------|-----|-----|-----|------|
|----------------|--------|-----|-----|-----|------|

INPUT LED

| | | | | | |
|--|-------|---|------|----|---------------|
| Reverse Leakage Current ($V_R = 3\text{ V}$) | I_R | — | 0.05 | 10 | μA |
| Forward Voltage ($I_F = 10\text{ mA}$) | V_F | — | 1.15 | 2 | Volts |
| Capacitance ($V_R = 0\text{ V}$, $f = 1\text{ MHz}$) | C | — | 18 | — | pF |

PHOTODARLINGTON ($T_A = 25^\circ\text{C}$ and $I_F = 0$, unless otherwise noted)

| | | | | | |
|---|---------------|----|---|---|---------------|
| Collector-Emitter Dark Current ($V_{CE} = 60\text{ V}$) | I_{CEO} | — | — | 1 | μA |
| Collector-Emitter Breakdown Voltage ($I_C = 1\text{ mA}$) | $V_{(BR)CEO}$ | 80 | — | — | Volts |
| Emitter-Collector Breakdown Voltage ($I_E = 100\text{ }\mu\text{A}$) | $V_{(BR)ECO}$ | 5 | — | — | Volts |

COUPLED ($T_A = 25^\circ\text{C}$ unless otherwise noted)

| | | | | | | |
|--|-----------|--------------------|----------|------------------|--------|-------------|
| Collector Output Current ($V_{CE} = 1.5\text{ V}$, $I_F = 10\text{ mA}$) | I_C | MOC8030 MOC8050 | 30 50 | — — | — — | mA |
| Isolation Surge Voltage (1, 2), 60 Hz Peak ac, 5 Second | V_{ISO} | | 7500 | — | — | Volts |
| Isolation Resistance (1) ($V = 500\text{ V}$) | R_{ISO} | | — | 10 ¹¹ | — | Ohms |
| Isolation Capacitance (1) ($V = 0\text{ V}$, $f = 1\text{ MHz}$) | C_{ISO} | | — | 0.2 | — | pF |

SWITCHING

| | | | | | | |
|---------------|--|-----------|---|-----|---|---------------|
| Turn-On Time | $V_{CC} = 10\text{ V}$, $R_L = 100\text{ }\Omega$, $I_F = 5\text{ mA}$ | t_{on} | — | 3.5 | — | μs |
| Turn-Off Time | | t_{off} | — | 95 | — | |
| Rise Time | | t_r | — | 1 | — | |
| Fall Time | | t_f | — | 2 | — | |

- (1) For this test LED Pins 1 and 2 are common and Phototransistor Pins 4 and 5 are common.
 (2) Isolation Surge Voltage, V_{ISO} , is an internal device dielectric breakdown rating.

6

TYPICAL CHARACTERISTICS

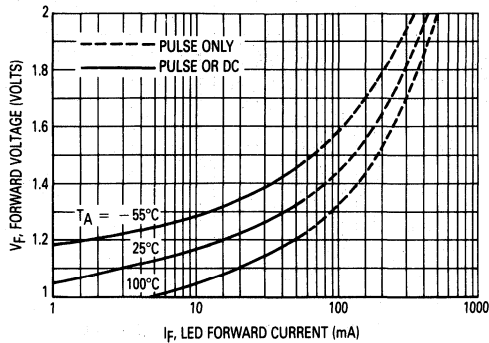

Figure 1. LED Forward Voltage versus Forward Current

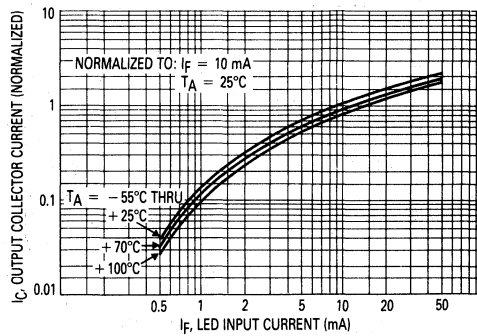

Figure 2. Output Current versus Input Current

MOC8030, MOC8050

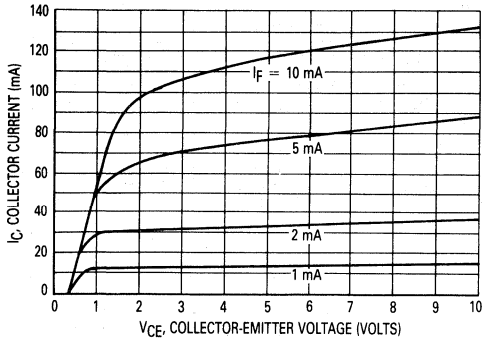

Figure 3. Collector Current versus Collector-Emitter Voltage

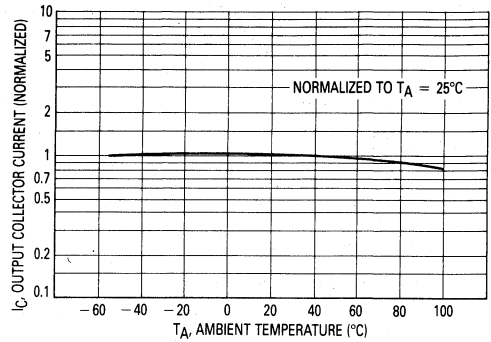

Figure 4. Output Current versus Ambient Temperature

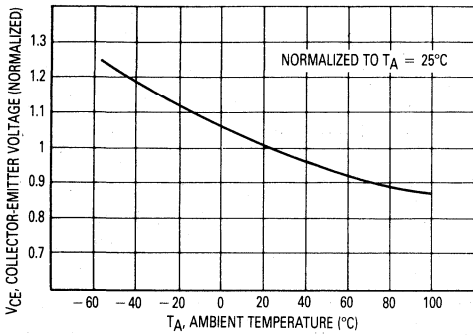

Figure 5. Collector-Emitter Voltage versus Ambient Temperature

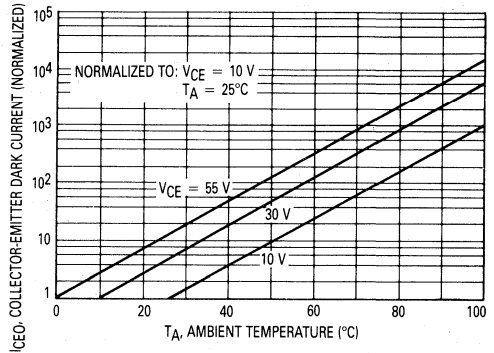

Figure 6. Collector-Emitter Dark Current versus Ambient Temperature

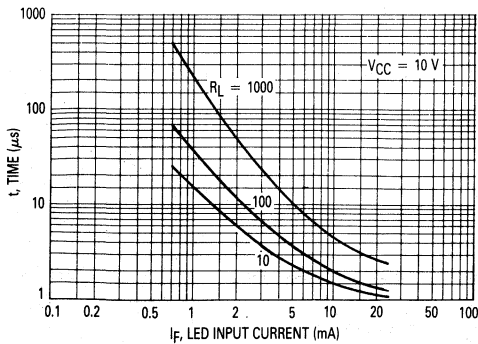

Figure 7. Turn-On Switching Times

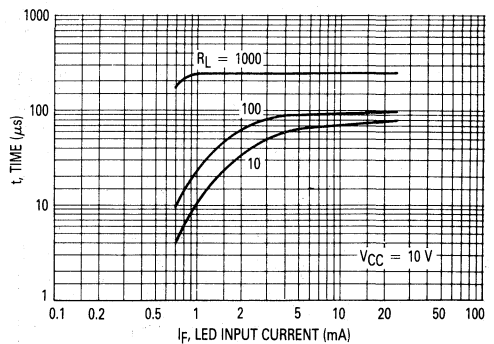

Figure 8. Turn-Off Switching Times

MOC8030, MOC8050

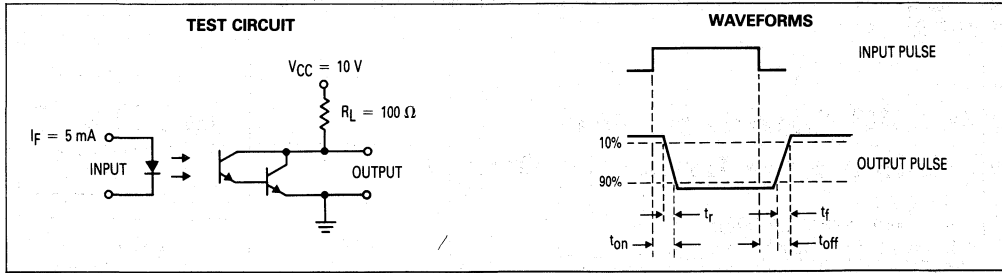
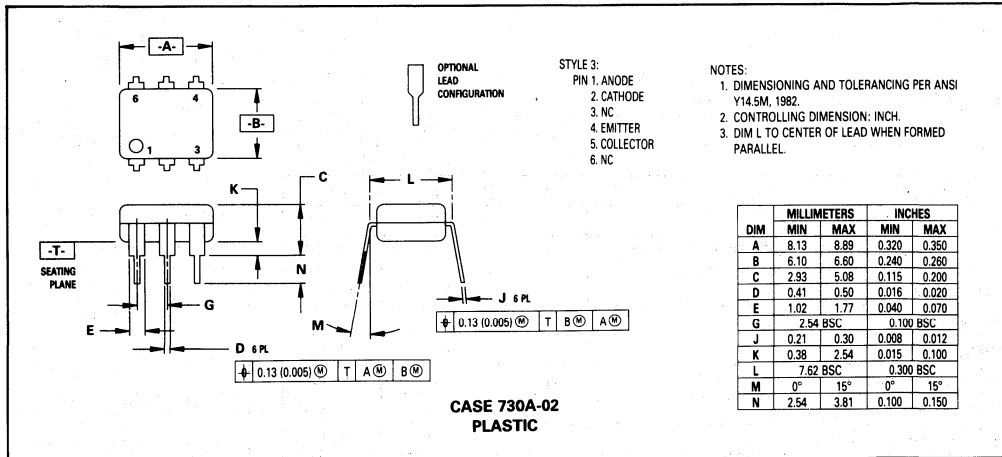



Figure 9. Switching Times

OUTLINE DIMENSIONS



6-Pin DIP Optoisolator High Temperature Darlington Output

- Convenient Plastic Dual-In-Line Package
- High Sensitivity to Low Input Drive Current
- Low, Stable Leakage Current at Elevated Temperature
- High Input-Output Isolation Guaranteed — 7500 Volts Peak
- UL Recognized. File Number E54915 
- VDE approved per standard 0883/6.80 (Certificate number 41853), with additional approval to DIN IEC380/VDE0806, IEC435/VDE0805, IEC65/VDE0860, VDE0110b, covering all other standards with equal or less stringent requirements, including IEC204/VDE0113, VDE0160, VDE0832, VDE0833, etc.  883
- Special lead form available (add suffix "T" to part number) which satisfies VDE0883/6.80 requirement for 8 mm minimum creepage distance between input and output solder pads.
- Various lead form options available. Consult "Optoisolator Lead Form Options" data sheet for details.

MOC8080

**6-PIN DIP
 OPTOISOLATOR
 HIGH TEMPERATURE
 DARLINGTON
 OUTPUT**



**CASE 730A-02
 PLASTIC**

MAXIMUM RATINGS ($T_A = 25^\circ\text{C}$ unless otherwise noted)

| Rating | Symbol | Value | Unit |
|---|--------|-------|----------------------------|
| INPUT LED | | | |
| Reverse Voltage | V_R | 6 | Volts |
| Forward Current — Continuous | I_F | 60 | mA |
| LED Power Dissipation @ $T_A = 25^\circ\text{C}$ with Negligible Power in Output Detector Derate above 25°C | P_D | 120 | mW |
| | | 1.41 | $\text{mW}/^\circ\text{C}$ |

OUTPUT DETECTOR

| | | | |
|--|-----------|------|----------------------------|
| Collector-Emitter Voltage | V_{CEO} | 55 | Volts |
| Emitter-Collector Voltage | V_{ECO} | 5 | Volts |
| Collector-Base Voltage | V_{CBO} | 55 | Volts |
| Collector Current — Continuous | I_C | 150 | mA |
| Detector Power Dissipation @ $T_A = 25^\circ\text{C}$ with Negligible Power in Input LED Derate above 25°C | P_D | 150 | mW |
| | | 1.76 | $\text{mW}/^\circ\text{C}$ |

TOTAL DEVICE

| | | | |
|--|-----------|-------------|----------------------------------|
| Isolation Source Voltage (1) (Peak ac Voltage, 60 Hz, 1 sec Duration) | V_{ISO} | 7500 | Vac |
| Total Device Power Dissipation @ $T_A = 25^\circ\text{C}$ Derate above 25°C | P_D | 250 2.94 | mW $\text{mW}/^\circ\text{C}$ |
| Ambient Operating Temperature Range | T_A | -55 to +100 | $^\circ\text{C}$ |
| Storage Temperature Range | T_{stg} | -55 to +150 | $^\circ\text{C}$ |
| Soldering Temperature (10 seconds, 1/16" from case) | — | 260 | $^\circ\text{C}$ |

(1) Isolation surge voltage is an internal device dielectric breakdown rating.

SCHEMATIC

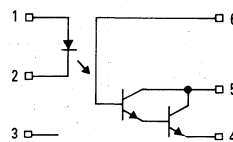

1. LED ANODE
2. LED CATHODE
3. N.C.
4. EMITTER
5. COLLECTOR
6. BASE

MOC8080

ELECTRICAL CHARACTERISTICS (T_A = 25°C unless otherwise noted)

| Characteristic | Symbol | Min | Typ | Max | Unit |
|--|---|-----|------|-----|------|
| INPUT LED | | | | | |
| Forward Voltage (I _F = 10 mA) | T _A = 25°C T _A = -55°C T _A = 100°C | 0.8 | 1.15 | 1.5 | V |
| | | 0.9 | 1.3 | 1.7 | |
| | | 0.7 | 1.05 | 1.4 | |
| Reverse Leakage Current (V _R = 3 V) | I _R | — | — | 100 | μA |
| Capacitance (V = 0 V, f = 1 MHz) | C | — | 18 | — | pF |

OUTPUT DETECTOR

| | | | | | | |
|--|---|------------------|------|-----|-----|----|
| Collector-Emitter Dark Current (V _{CE} = 10 V) | T _A = 25°C T _A = 100°C | I _{CEO} | — | 5 | 100 | nA |
| | | I _{CEO} | — | 5 | 100 | μA |
| Collector-Base Dark Current (V _{CB} = 10 V) | T _A = 25°C T _A = 100°C | I _{CBO} | — | 1 | 20 | nA |
| | | I _{CBO} | — | 100 | — | — |
| Collector-Emitter Breakdown Voltage (I _C = 1 mA) | V _{(BR)CEO} | 55 | 80 | — | V | |
| Collector-Base Breakdown Voltage (I _C = 100 μA) | V _{(BR)CBO} | 55 | 100 | — | V | |
| Emitter-Collector Breakdown Voltage (I _E = 100 μA) | V _{(BR)ECO} | 5 | 7 | — | V | |
| DC Current Gain (I _C = 5 mA, V _{CE} = 5 V) | h _{FE} | — | 16 k | — | — | |
| Collector-Emitter Capacitance (f = 1 MHz, V _{CE} = 5 V) | C _{CE} | — | 3.9 | — | pF | |
| Collector-Base Capacitance (f = 1 MHz, V _{CB} = 5 V) | C _{CB} | — | 6.3 | — | pF | |
| Emitter-Base Capacitance (f = 1 MHz, V _{EB} = 5 V) | C _{EB} | — | 3.8 | — | pF | |

COUPLED

| | | | | | |
|---|---|------------------|-----|-----|---------|
| Output Collector Current (I _F = 10 mA, V _{CE} = 5 V) | I _C | 50 | 117 | — | mA |
| Collector-Emitter Saturation Voltage (I _C = 1 mA, I _F = 1 mA) | V _{CE(sat)} | — | 0.6 | 1 | V |
| Turn-On Time | V _{CC} = 10 V, R _L = 100 Ω, I _F = 5 mA | t _{on} | — | 3.5 | μs |
| Turn-Off Time | | t _{off} | — | 95 | |
| Rise Time | | t _r | — | 1 | |
| Fall Time | | t _f | — | 2 | |
| Isolation Voltage (f = 60 Hz, t = 1 sec) (1) | V _{ISO} | 7500 | — | — | Vac(pk) |
| Isolation Resistance (V = 500 V) (1) | R _{ISO} | 10 ¹¹ | — | — | Ω |
| Isolation Capacitance (V = 0 V, f = 1 MHz) (1) | C _{ISO} | — | 0.2 | 2 | pF |

Note: (1) For this test, Pins 1 and 2 are common, and Pins 4, 5 and 6 are common.

6

TYPICAL CHARACTERISTICS

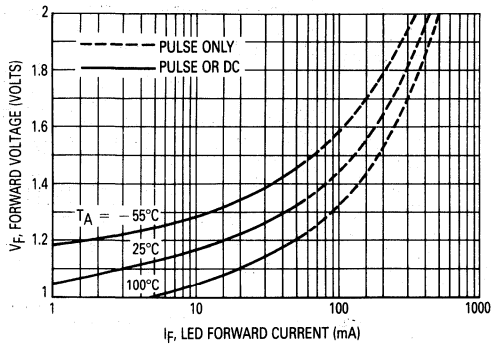

Figure 1. LED Forward Voltage versus Forward Current

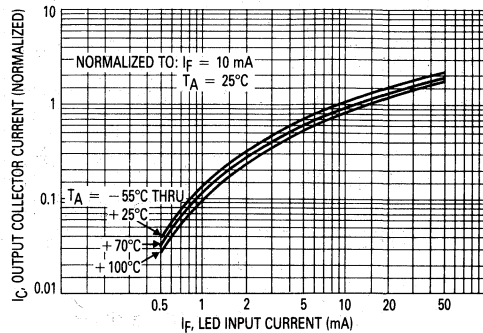

Figure 2. Output Current versus Input Current

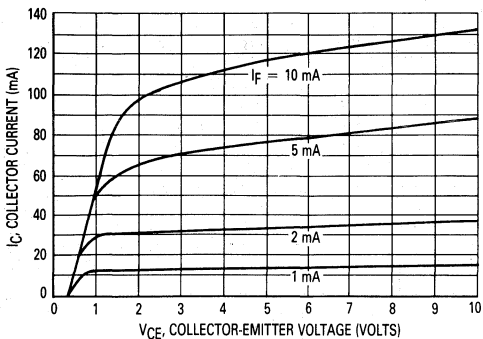

Figure 3. Collector Current versus Collector-Emitter Voltage

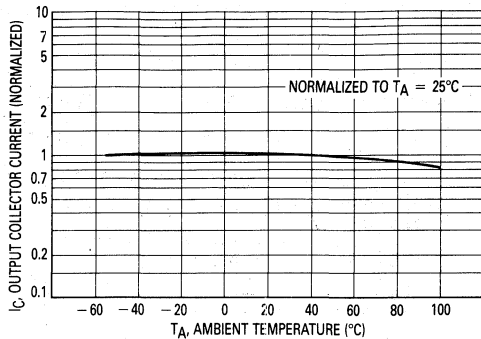

Figure 4. Output Current versus Ambient Temperature

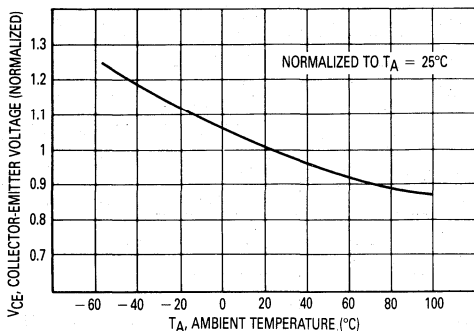

Figure 5. Collector-Emitter Voltage versus Ambient Temperature

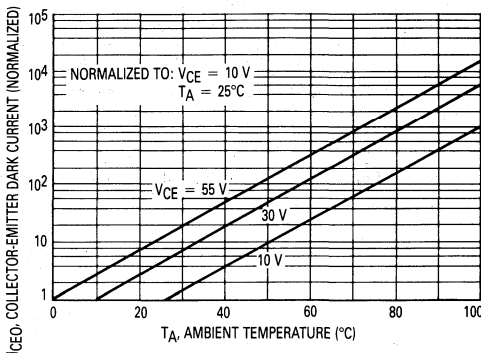

Figure 6. Collector-Emitter Dark Current versus Ambient Temperature

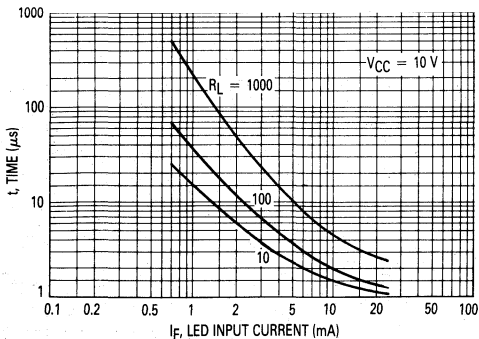

Figure 7. Turn-On Switching Times

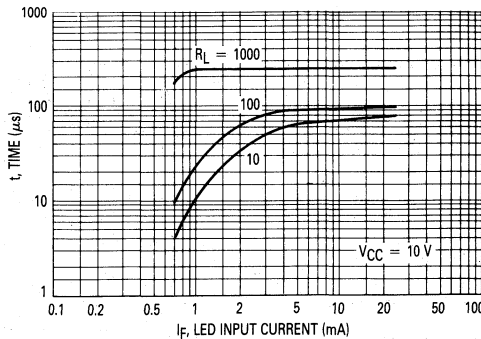

Figure 8. Turn-Off Switching Times



MOC8080

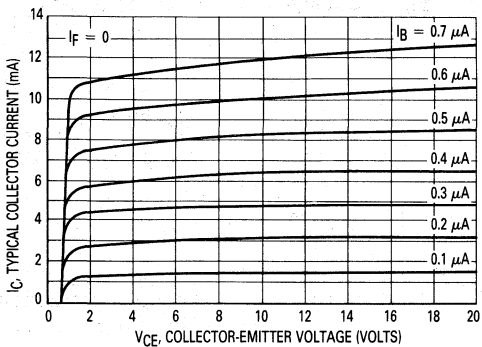

Figure 9. DC Current Gain (Detector Only)

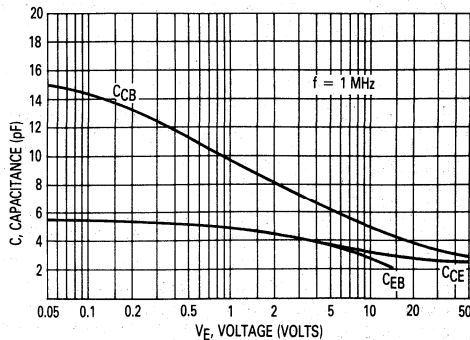

Figure 10. Detector Capacitances versus Voltage

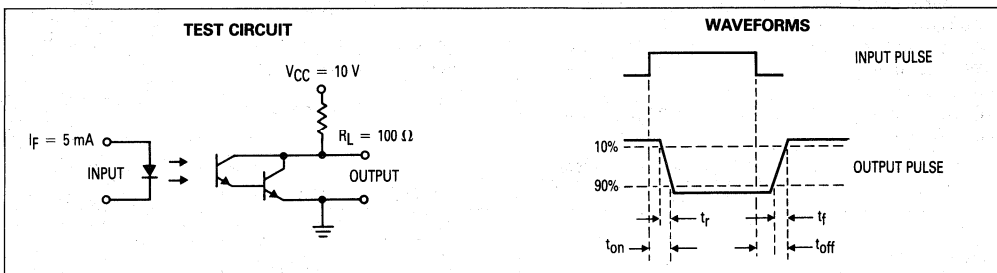
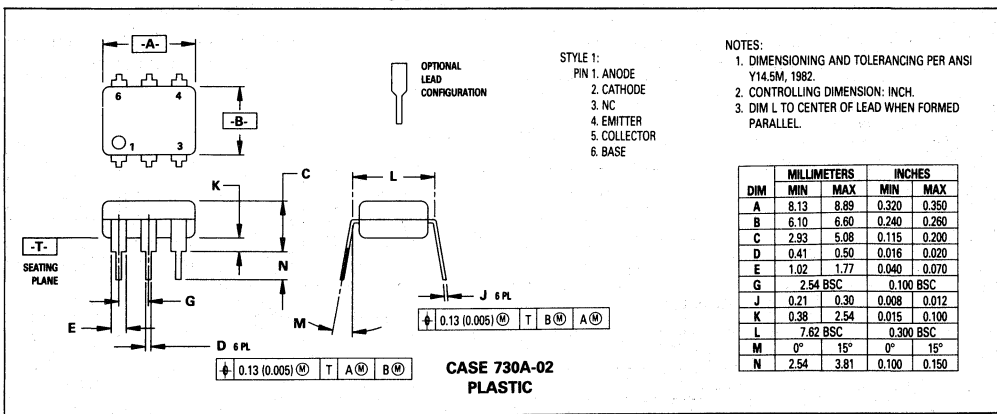



Figure 11. Switching Times

OUTLINE DIMENSIONS



6-Pin DIP Optoisolator Transistor Output

This device consists of a gallium arsenide infrared emitting diode optically coupled to a monolithic silicon phototransistor detector. It is designed for applications requiring low LED drive current.

- High Current Transfer Ratio Guaranteed at 1 mA LED Drive Level
- Convenient Plastic Dual-in-Line Package
- High Input-Output Isolation Guaranteed — 7500 Volts Peak
- UL Recognized. File Number E54915 
- VDE approved per standard 0883/6.80 (Certificate number 41853), with additional approval to DIN IEC380/VDE0806, IEC435/VDE0805, IEC65/VDE0860, VDE110b, covering all other standards with equal or less stringent requirements, including IEC204/ 883 VDE0113, VDE0160, VDE0832, VDE0833, etc.
- Special lead form available (add suffix "T" to part number) which satisfies VDE0883/6.80 requirement for 8 mm minimum creepage distance between input and output solder pads.
- Various lead form options available. Consult "Optoisolator Lead Form Options" data sheet for details.

MAXIMUM RATINGS ($T_A = 25^\circ\text{C}$ unless otherwise noted)

| Rating | Symbol | Value | Unit |
|---|--------|-------|----------------------|
| INPUT LED | | | |
| Reverse Voltage | V_R | 6 | Volts |
| Forward Current — Continuous | I_F | 60 | mA |
| LED Power Dissipation @ $T_A = 25^\circ\text{C}$ with Negligible Power in Output Detector Derate above 25°C | P_D | 120 | mW |
| | | 1.41 | mW/ $^\circ\text{C}$ |

OUTPUT TRANSISTOR

| | | | |
|--|-----------|------|----------------------|
| Collector-Emitter Voltage | V_{CE0} | 30 | Volts |
| Emitter-Base Voltage | V_{EBO} | 7 | Volts |
| Collector-Base Voltage | V_{CBO} | 70 | Volts |
| Collector Current — Continuous | I_C | 150 | mA |
| Detector Power Dissipation @ $T_A = 25^\circ\text{C}$ with Negligible Power in Input LED Derate above 25°C | P_D | 150 | mW |
| | | 1.76 | mW/ $^\circ\text{C}$ |

TOTAL DEVICE

| | | | |
|--|-----------|-------------|----------------------------|
| Isolation Surge Voltage (1) (Peak ac Voltage, 60 Hz, 1 sec Duration) | V_{ISO} | 7500 | Vac |
| Total Device Power Dissipation @ $T_A = 25^\circ\text{C}$ Derate above 25°C | P_D | 250 2.94 | mW mW/ $^\circ\text{C}$ |
| Ambient Operating Temperature Range | T_A | -55 to +100 | $^\circ\text{C}$ |
| Storage Temperature Range | T_{stg} | -55 to +150 | $^\circ\text{C}$ |
| Soldering Temperature (10 sec, 1/16" from case) | T_{sol} | 260 | $^\circ\text{C}$ |

(1) Isolation surge voltage is an internal device dielectric breakdown rating. For this test, Pins 1 and 2 are common, and Pins 4, 5 and 6 are common.

MOC8100

**6-PIN DIP
 OPTOISOLATOR
 TRANSISTOR OUTPUT**

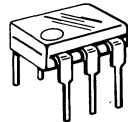

**CASE 730A-02
 PLASTIC**

SCHEMATIC

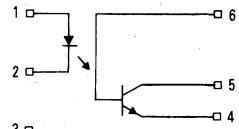

1. LED ANODE
2. LED CATHODE
3. N.C.
4. EMITTER
5. COLLECTOR
6. BASE

MOC8100

ELECTRICAL CHARACTERISTICS ($T_A = 25^\circ\text{C}$ unless otherwise noted)

| Characteristic | Symbol | Min | Typ | Max | Unit |
|---|--------|-----|------|-----|---------------|
| INPUT LED | | | | | |
| Forward Voltage ($I_F = 10\text{ mA}$) | V_F | — | 1.15 | 1.4 | Volts |
| | | | 1.3 | — | |
| | | | 1.05 | — | |
| Reverse Leakage Current ($V_R = 6\text{ V}$) | I_R | — | 0.05 | 10 | μA |
| Capacitance ($V = 0\text{ V}$, $f = 1\text{ MHz}$) | C_J | — | 18 | — | pF |

OUTPUT TRANSISTOR

| | | | | | |
|---|---------------|----|--|------|---------------|
| Collector-Emitter Dark Current | I_{CEO} | — | 3 | 25 | nA |
| | | | ($V_{CE} = 5\text{ V}$, $T_A = 25^\circ\text{C}$) | 0.05 | |
| | I_{CEO} | — | 0.05 | 50 | μA |
| Collector-Base Dark Current ($V_{CB} = 5\text{ V}$) | I_{CBO} | — | 0.2 | 10 | nA |
| Collector-Emitter Breakdown Voltage ($I_C = 1\text{ mA}$) | $V_{(BR)CEO}$ | 30 | 45 | — | Volts |
| Collector-Base Breakdown Voltage ($I_C = 100\ \mu\text{A}$) | $V_{(BR)CBO}$ | 70 | 100 | — | Volts |
| Emitter-Base Breakdown Voltage ($I_E = 100\ \mu\text{A}$) | $V_{(BR)EBO}$ | 7 | 7.8 | — | Volts |
| DC Current Gain ($I_C = 1\text{ mA}$, $V_{CE} = 5\text{ V}$) | h_{FE} | — | 600 | — | — |
| Collector-Emitter Capacitance ($f = 1\text{ MHz}$, $V_{CE} = 0$) | C_{CE} | — | 7 | — | pF |
| Collector-Base Capacitance ($f = 1\text{ MHz}$, $V_{CB} = 0$) | C_{CB} | — | 19 | — | pF |
| Emitter-Base Capacitance ($f = 1\text{ MHz}$, $V_{EB} = 0$) | C_{EB} | — | 9 | — | pF |

COUPLED

| | | | | | |
|--|---------------|-----------|------|-----|------------------|
| Output Collector Current ($I_F = 1\text{ mA}$, $V_{CE} = 5\text{ V}$) ($I_F = 1\text{ mA}$, $V_{CE} = 5\text{ V}$, $T_A = 0\text{ to }+70^\circ\text{C}$) | I_C | 0.5 | 1 | — | mA |
| | | 0.3 | 0.6 | — | |
| Collector-Emitter Saturation Voltage ($I_C = 100\ \mu\text{A}$, $I_F = 1\text{ mA}$) | $V_{CE(sat)}$ | — | 0.22 | 0.5 | Volts |
| Turn-On Time ($I_C = 2\text{ mA}$, $V_{CC} = 10\text{ V}$, $R_L = 100\ \Omega$, Figure 11) | t_{on} | — | 9 | 20 | μs |
| Turn-Off Time ($I_C = 2\text{ mA}$, $V_{CC} = 10\text{ V}$, $R_L = 100\ \Omega$, Figure 11) | t_{off} | — | 7 | 20 | μs |
| Rise Time ($I_C = 2\text{ mA}$, $V_{CC} = 10\text{ V}$, $R_L = 100\ \Omega$, Figure 11) | t_r | — | 3.8 | — | μs |
| Fall Time ($I_C = 2\text{ mA}$, $V_{CC} = 10\text{ V}$, $R_L = 100\ \Omega$, Figure 11) | t_f | — | 5.6 | — | μs |
| Isolation Voltage ($f = 60\text{ Hz}$, $t = 1\text{ sec}$) | V_{ISO} | 7500 | — | — | Vac(pk) |
| Isolation Resistance ($V = 500\text{ V}$) | R_{ISO} | 10^{11} | — | — | Ω |
| Isolation Capacitance ($V = 0\text{ V}$, $f = 1\text{ MHz}$) | C_{ISO} | — | 0.2 | 2 | pF |

6

TYPICAL CHARACTERISTICS

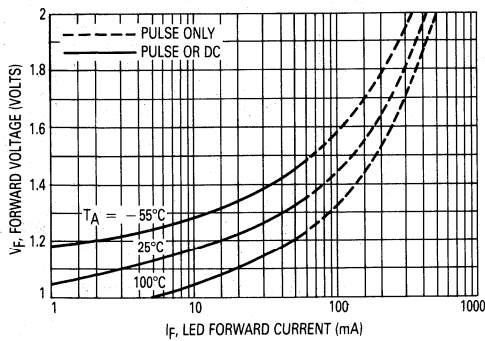

Figure 1. LED Forward Voltage versus Forward Current

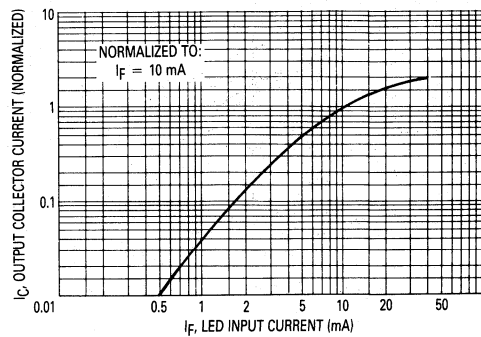

Figure 2. Output Current versus Input Current

MOC8100

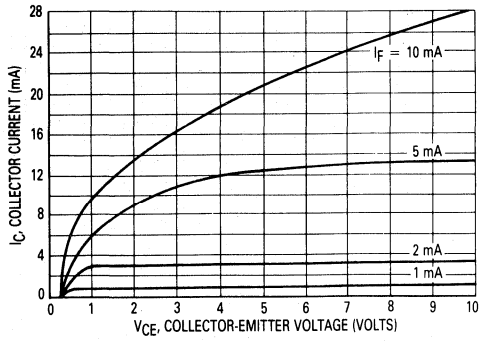

Figure 3. Collector Current versus Collector-Emitter Voltage

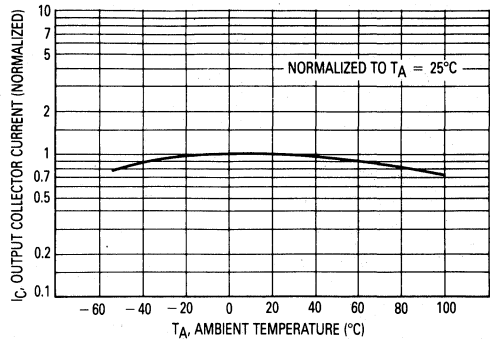

Figure 4. Output Current versus Ambient Temperature

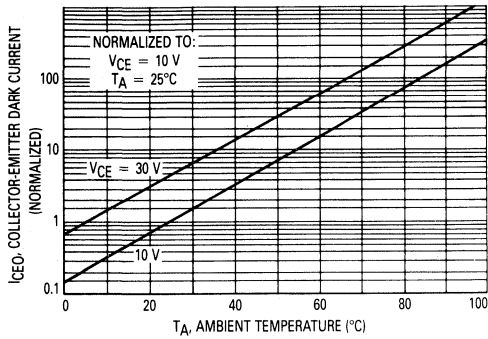

Figure 5. Dark Current versus Ambient Temperature

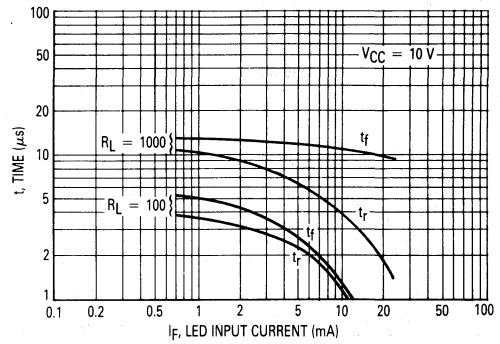

Figure 6. Rise and Fall Times

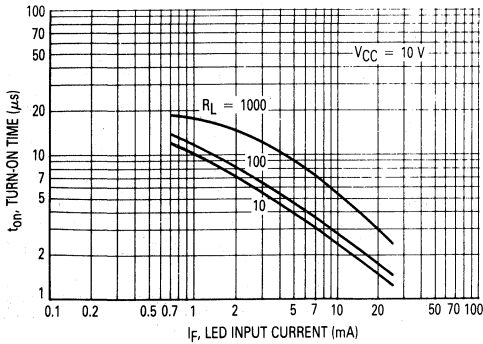

Figure 7. Turn-On Switching Times

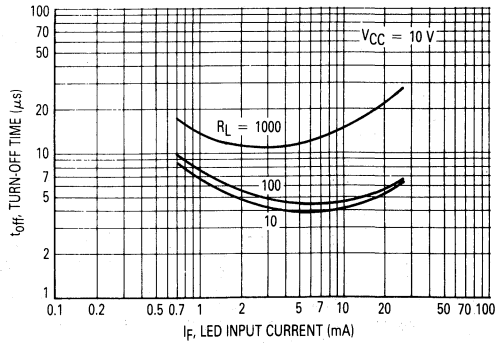

Figure 8. Turn-Off Switching Times

MOC8100

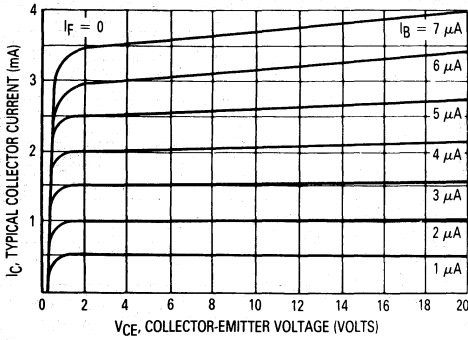

Figure 9. DC Current Gain (Detector Only)

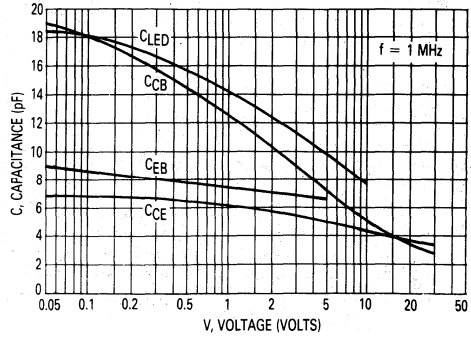

Figure 10. Capacitances versus Voltage

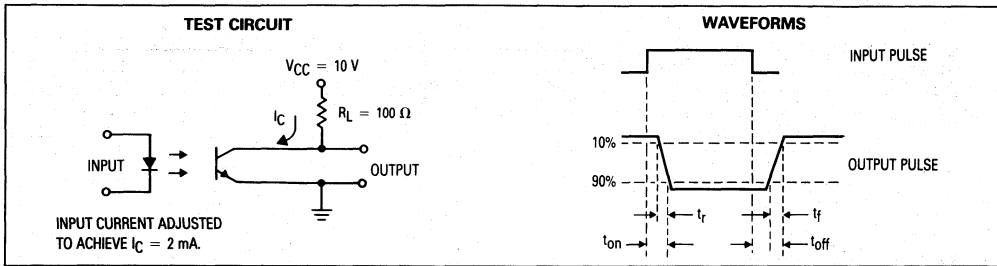
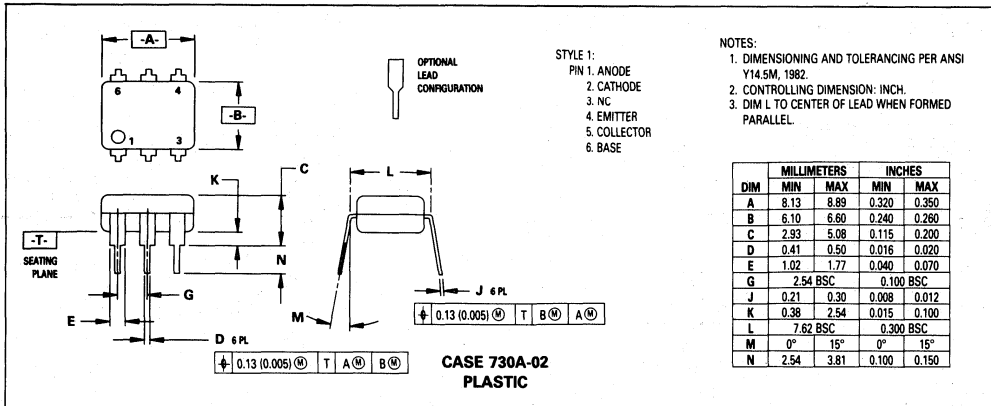



Figure 11. Switching Times

OUTLINE DIMENSIONS



6-Pin DIP Optoisolators For Power Supply Applications

These devices consist of a gallium arsenide infrared emitting diode optically coupled to a monolithic silicon phototransistor detector. They have been designed and specified to meet the requirements of switchmode power supplies and other applications requiring very closely matched current transfer ratios (CTR), linearity and stable performance over the temperature range. The internal base-to-Pin 6 connection has been eliminated for improved noise immunity.

- Convenient Plastic Dual-in-Line Package
- High Input-Output Isolation Guaranteed 3750 Vac(rms)
- UL recognized. File Number E54915 
- VDE approved per standard 0883/6.80 (Certificate number 41853), with additional approval to DIN IEC380/VDE0806, IEC435/VDE0805, IEC65/VDE0860, VDE0110b, covering all other standards with equal or less stringent requirements, including IEC204/VDE0113, VDE0160, VDE0832, VDE0833, etc. 
- Special lead form available (add suffix "T" to part number) which satisfies VDE0883/6.80 requirement for 8 mm minimum creepage distance between input and output solder pads.
- Other lead forms available. Consult "Optoisolator Lead Form Options" data sheet for details.

MOC8101
MOC8102
MOC8103
MOC8104

**6-PIN DIP
 OPTOISOLATORS
 TRANSISTOR OUTPUT**

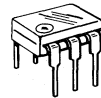

**CASE 730A-02
 PLASTIC**

MAXIMUM RATINGS ($T_A = 25^\circ\text{C}$ unless otherwise noted)

| Rating | Symbol | Value | Unit |
|---|-------------|-------------|----------------------------|
| INPUT LED | | | |
| Forward Current — Continuous | I_F | 60 | mA |
| Forward Current-Peak (PW = 100 μs , 120 pps) | $I_{F(pk)}$ | 1.0 | A |
| Reverse Voltage | V_R | 6.0 | V |
| LED Power Dissipation @ $T_A = 25^\circ\text{C}$ Derate above 25°C | P_D | 120 1.41 | mW mW/ $^\circ\text{C}$ |

OUTPUT TRANSISTOR

| | | | |
|--|-----------|-------------|----------------------------|
| Collector-Emitter Voltage | V_{CEO} | 30 | V |
| Emitter-Collector Voltage | V_{ECO} | 7.0 | V |
| Collector Current — Continuous | I_C | 150 | mA |
| Detector Power Dissipation @ $T_A = 25^\circ\text{C}$ Derate above 25°C | P_D | 150 1.76 | mW mW/ $^\circ\text{C}$ |

TOTAL DEVICE

| | | | |
|--|-----------|-------------|----------------------------|
| Input-Output Isolation Voltage (1) (f = 60 Hz, t = 1 sec.) | V_{ISO} | 3750 | Vac(rms) |
| Total Device Power Dissipation @ $T_A = 25^\circ\text{C}$ Derate above 25°C | P_D | 250 2.94 | mW mW/ $^\circ\text{C}$ |
| Ambient Operating Temperature Range | T_A | -55 to +100 | $^\circ\text{C}$ |
| Storage Temperature Range | T_{stg} | -55 to +150 | $^\circ\text{C}$ |
| Lead Soldering Temperature (1/16" from case, 10 sec. duration) | — | 260 | $^\circ\text{C}$ |

SCHEMATIC

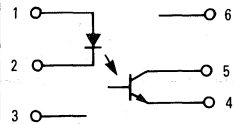

1. LED ANODE
2. LED CATHODE
3. NO CONNECTION
4. EMITTER
5. COLLECTOR
6. NO CONNECTION

(1) Input-Output Isolation Voltage, V_{ISO} , is an internal device dielectric breakdown rating. For this test, Pins 1 and 2 are common, and Pins 4, 5 and 6 are common.

MOC8101, MOC8102, MOC8103, MOC8104

ELECTRICAL CHARACTERISTICS ($T_A = 25^\circ\text{C}$ unless otherwise noted)

| Characteristic | Symbol | Min | Typ | Max | Unit |
|--|--------|-----|------|-----|---------------|
| INPUT LED | | | | | |
| Forward Voltage ($I_F = 10\text{ mA}$) | V_F | 1.0 | 1.15 | 1.5 | V |
| Reverse Leakage Current ($V_R = 5.0\text{ V}$) | I_R | — | 0.05 | 10 | μA |
| Capacitance | C | — | 18 | — | pF |

OUTPUT TRANSISTOR

| | | | | | |
|---|---------------|-----|-----|----|---------------|
| Collector-Emitter Dark Current ($V_{CE} = 10\text{ V}$, $T_A = 25^\circ\text{C}$) | I_{CEO1} | — | 1.0 | 50 | nA |
| | I_{CEO2} | — | 1.0 | — | μA |
| Collector-Emitter Breakdown Voltage ($I_C = 1.0\text{ mA}$) | $V_{(BR)CEO}$ | 30 | 45 | — | V |
| Emitter-Collector Breakdown Voltage ($I_E = 100\ \mu\text{A}$) | $V_{(BR)ECO}$ | 7.0 | 7.8 | — | V |
| Collector-Emitter Capacitance ($f = 1.0\text{ MHz}$, $V_{CE} = 0$) | C_{CE} | — | 7.0 | — | pF |

COUPLED

| | | | | | | |
|---|--|---------------|--------------------------|------------------------|-----------------------------|---------------|
| Output Collector Current ($I_F = 10\text{ mA}$, $V_{CE} = 10\text{ V}$) | MOC8101 MOC8102 MOC8103 MOC8104 | I_C | 5.0 7.3 10.8 16 | 6.5 9.0 14 20 | 8.0 11.7 17.3 25.6 | mA |
| Collector-Emitter Saturation Voltage ($I_C = 500\ \mu\text{A}$, $I_F = 5.0\text{ mA}$) | | $V_{CE(sat)}$ | — | 0.15 | 0.4 | V |
| Turn-On Time ($I_C = 2.0\text{ mA}$, $V_{CC} = 10\text{ V}$, $R_L = 100\ \Omega$) | | t_{on} | — | 7.5 | 20 | μs |
| Turn-Off Time ($I_C = 2.0\text{ mA}$, $V_{CC} = 10\text{ V}$, $R_L = 100\ \Omega$) | | t_{off} | — | 5.7 | 20 | μs |
| Rise Time ($I_C = 2.0\text{ mA}$, $V_{CC} = 10\text{ V}$, $R_L = 100\ \Omega$) | | t_r | — | 3.2 | — | μs |
| Fall Time ($I_C = 2.0\text{ mA}$, $V_{CC} = 10\text{ V}$, $R_L = 100\ \Omega$) | | t_f | — | 4.7 | — | μs |
| Isolation Voltage ($f = 60\text{ Hz}$, $t = 1.0\text{ sec.}$) | | V_{ISO} | 3750 | — | — | Vac(rms) |
| Isolation Resistance ($V_{I-O} = 500\text{ V}$) | | R_{ISO} | 10^{11} | — | — | Ω |
| Isolation Capacitance ($V_{I-O} = 0$, $f = 1.0\text{ MHz}$) | | C_{ISO} | — | 0.2 | — | pF |

TYPICAL CHARACTERISTICS

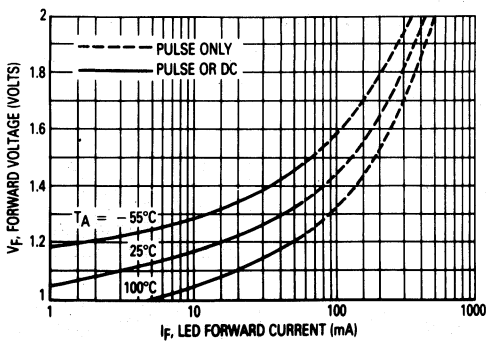

Figure 1. LED Forward Voltage versus Forward Current

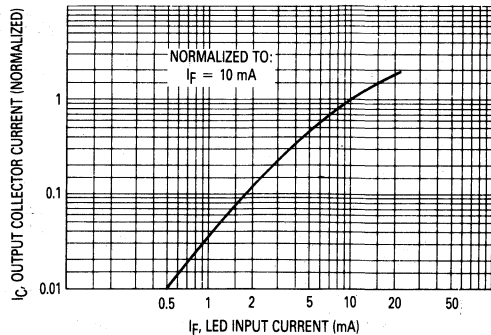

Figure 2. Output Current versus Input Current

MOC8101, MOC8102, MOC8103, MOC8104

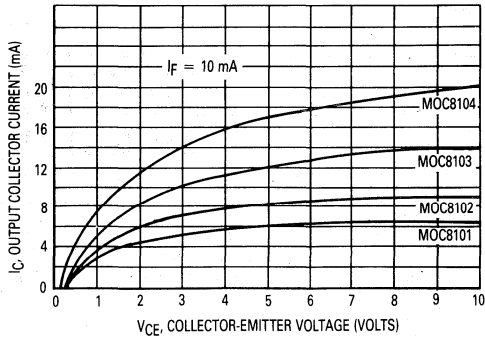

Figure 3. Output Current versus Collector-Emitter Voltage

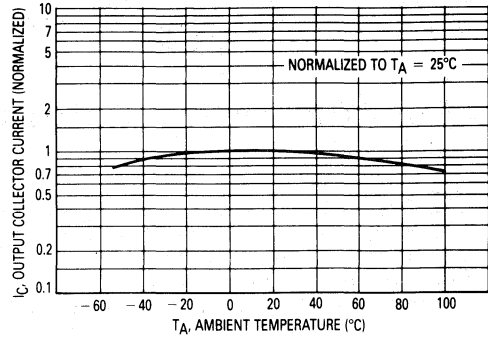

Figure 4. Output Current versus Ambient Temperature

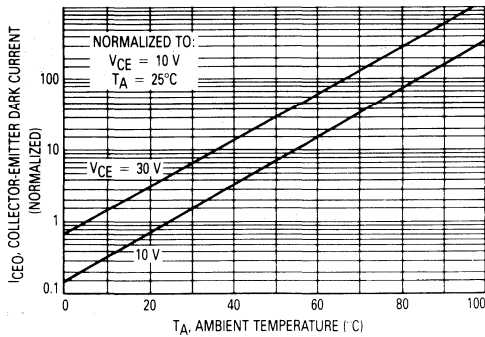

Figure 5. Dark Current versus Ambient Temperature

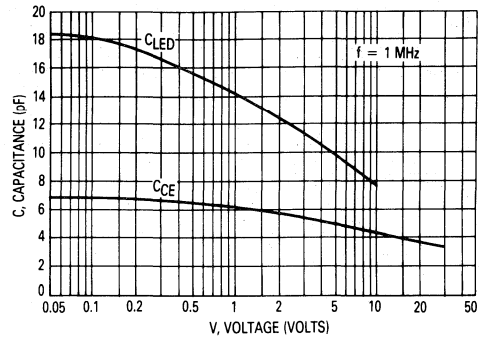
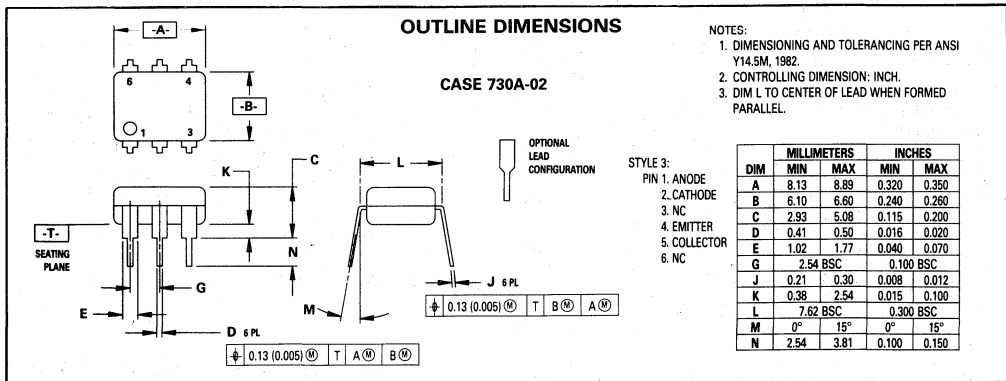





Figure 6. Capacitance versus Voltage



6-Pin DIP Optoisolators Transistor Output

These devices consist of a gallium arsenide infrared emitting diode optically coupled to a monolithic silicon phototransistor detector. The internal base-to-Pin 6 connection has been eliminated for improved noise immunity.

- Convenient Plastic Dual-in-Line Package
- High Input-Output Isolation Guaranteed — 7500 Volts Peak
- UL Recognized. File Number E54915 
- VDE approved per standard 0883/6.80 (Certificate number 41853), with additional approval to DIN IEC380/VDE0806, IEC435/VDE0805, IEC65/VDE0860, VDE0110b, covering all other standards with equal or less stringent requirements, including IEC204/VDE0113, VDE0160, VDE0832, VDE0833, etc. 
- No Base Connection for Improved Noise Immunity 
- Special lead form available (add suffix "T" to part number) which satisfies VDE0883/6.80 requirement for 8 mm minimum creepage distance between input and output solder pads.
- Various lead form options available. Consult "Optoisolator Lead Form Options" data sheet for details.

MAXIMUM RATINGS ($T_A = 25^\circ\text{C}$ unless otherwise noted)

| Rating | Symbol | Value | Unit |
|---|--------|-------|----------------------|
| INPUT LED | | | |
| Reverse Voltage | V_R | 6 | Volts |
| Forward Current — Continuous | I_F | 60 | mA |
| LED Power Dissipation @ $T_A = 25^\circ\text{C}$ with Negligible Power in Output Detector Derate above 25°C | P_D | 120 | mW |
| | | 1.41 | mW/ $^\circ\text{C}$ |

OUTPUT TRANSISTOR

| | | | |
|--|-----------|------|----------------------|
| Collector-Emitter Voltage | V_{CEO} | 30 | Volts |
| Emitter-Collector Voltage | V_{ECO} | 7 | Volts |
| Collector Current — Continuous | I_C | 150 | mA |
| Detector Power Dissipation @ $T_A = 25^\circ\text{C}$ with Negligible Power in Input LED Derate above 25°C | P_D | 150 | mW |
| | | 1.76 | mW/ $^\circ\text{C}$ |

TOTAL DEVICE

| | | | |
|--|-----------|-------------|----------------------------|
| Isolation Surge Voltage (1) (Peak ac Voltage, 60 Hz, 1 sec Duration) | V_{ISO} | 7500 | Vac |
| Total Device Power Dissipation @ $T_A = 25^\circ\text{C}$ Derate above 25°C | P_D | 250 2.94 | mW mW/ $^\circ\text{C}$ |
| Ambient Operating Temperature Range | T_A | -55 to +100 | $^\circ\text{C}$ |
| Storage Temperature Range | T_{stg} | -55 to +150 | $^\circ\text{C}$ |
| Soldering Temperature (10 sec, 1/16" from case) | T_{sol} | 260 | $^\circ\text{C}$ |

(1) Isolation surge voltage is an internal device dielectric breakdown rating. For this test, Pins 1 and 2 are common, and Pins 4, 5 and 6 are common.

MOC8111
MOC8112
MOC8113

**6-PIN DIP
 OPTOISOLATORS
 TRANSISTOR OUTPUT**

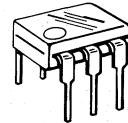

**CASE 730A-02
 PLASTIC**

SCHEMATIC

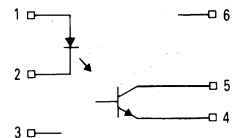

1. LED ANODE
2. LED CATHODE
3. NO CONNECTION
4. EMITTER
5. COLLECTOR
6. NO CONNECTION

MOC8111, MOC8112, MOC8113

ELECTRICAL CHARACTERISTICS ($T_A = 25^\circ\text{C}$ unless otherwise noted)

| Characteristic | Symbol | Min | Typ | Max | Unit |
|---|---------------|-----------|------|-----|------------------|
| INPUT LED | | | | | |
| Forward Voltage ($I_F = 10\text{ mA}$) | V_F | — | 1.15 | 1.5 | Volts |
| | | | 1.3 | — | |
| | | | 1.05 | — | |
| Reverse Leakage Current ($V_R = 6\text{ V}$) | I_R | — | 0.05 | 10 | μA |
| Capacitance ($V = 0, f = 1\text{ MHz}$) | C_J | — | 18 | — | pF |
| OUTPUT TRANSISTOR | | | | | |
| Collector-Emitter Dark Current | I_{CEO} | — | 1 | 50 | nA |
| | | | 1 | — | μA |
| Collector-Emitter Breakdown Voltage ($I_C = 1\text{ mA}$) | $V_{(BR)CEO}$ | 30 | 45 | — | Volts |
| Emitter-Collector Breakdown Voltage ($I_E = 100\ \mu\text{A}$) | $V_{(BR)ECO}$ | 7 | 7.8 | — | Volts |
| Collector-Emitter Capacitance ($f = 1\text{ MHz}, V_{CE} = 0$) | C_{CE} | — | 7 | — | pF |
| COUPLED | | | | | |
| Output Collector Current ($I_F = 10\text{ mA}, V_{CE} = 10\text{ V}$) | I_C | 2 | 5 | — | mA |
| | | 5 | 10 | — | |
| | | 10 | 20 | — | |
| Collector-Emitter Saturation Voltage ($I_C = 500\ \mu\text{A}, I_F = 10\text{ mA}$) | $V_{CE(sat)}$ | — | 0.15 | 0.4 | Volts |
| Turn-On Time ($I_C = 2\text{ mA}, V_{CC} = 10\text{ V}, R_L = 100\ \Omega$, Figure 10) | t_{on} | — | 7.5 | 20 | μs |
| Turn-Off Time ($I_C = 2\text{ mA}, V_{CC} = 10\text{ V}, R_L = 100\ \Omega$, Figure 10) | t_{off} | — | 5.7 | 20 | μs |
| Rise Time ($I_C = 2\text{ mA}, V_{CC} = 10\text{ V}, R_L = 100\ \Omega$, Figure 10) | t_r | — | 3.2 | — | μs |
| Fall Time ($I_C = 2\text{ mA}, V_{CC} = 10\text{ V}, R_L = 100\ \Omega$, Figure 10) | t_f | — | 4.7 | — | μs |
| Isolation Voltage ($f = 60\text{ Hz}, t = 1\text{ sec}$) | V_{ISO} | 7500 | — | — | Vac(pk) |
| Isolation Resistance ($V = 500\text{ V}$) | R_{ISO} | 10^{11} | — | — | Ω |
| Isolation Capacitance ($V = 0, f = 1\text{ MHz}$) | C_{ISO} | — | 0.2 | — | pF |

6

TYPICAL CHARACTERISTICS

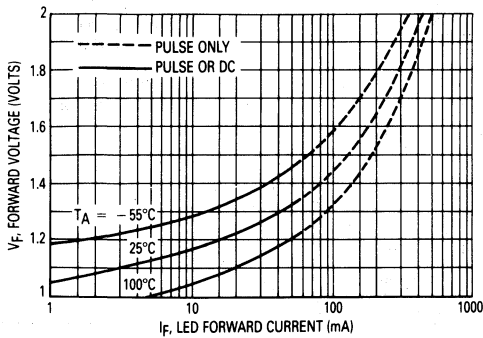

Figure 1. LED Forward Voltage versus Forward Current

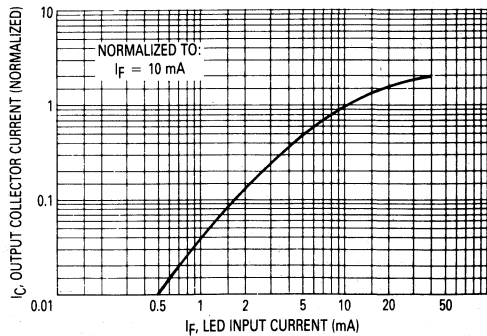

Figure 2. Output Current versus Input Current

MOC8111, MOC8112, MOC8113

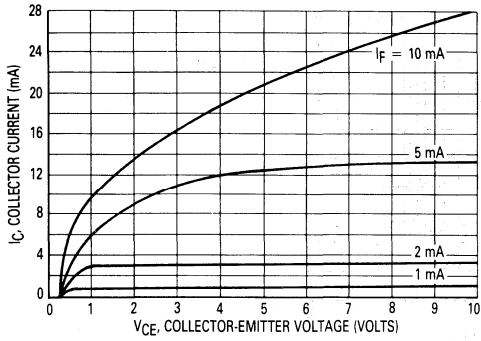

Figure 3. Collector Current versus Collector-Emitter Voltage

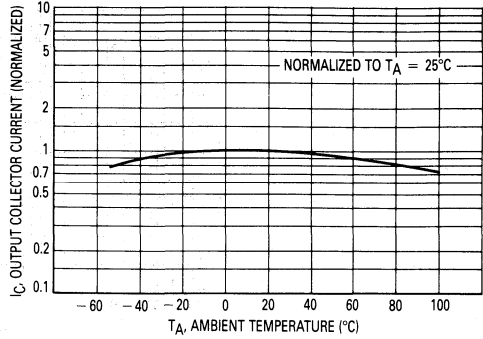

Figure 4. Output Current versus Ambient Temperature

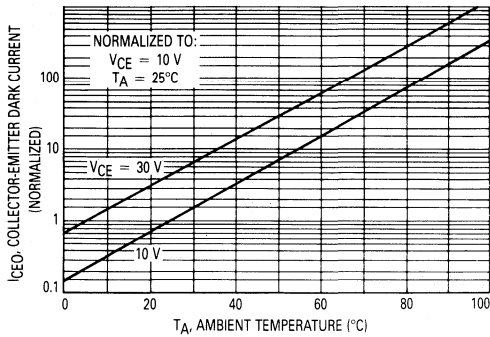

Figure 5. Dark Current versus Ambient Temperature

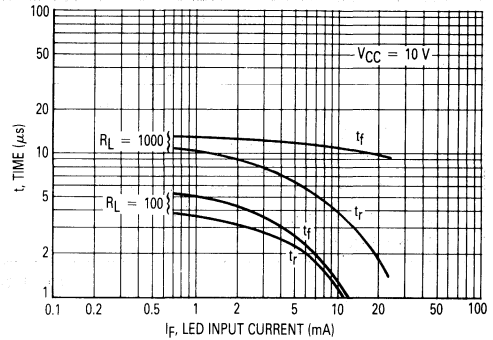

Figure 6. Rise and Fall Times

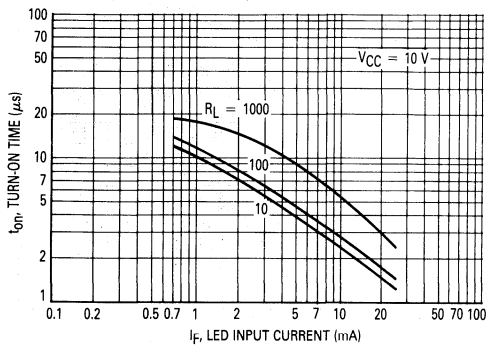

Figure 7. Turn-On Switching Times

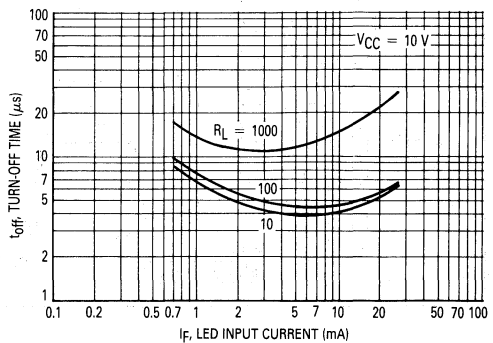

Figure 8. Turn-Off Switching Times

MOC8111, MOC8112, MOC8113

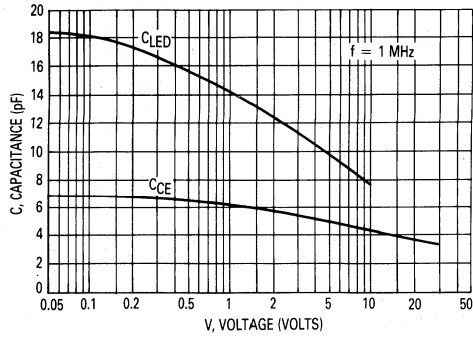

Figure 9. Capacitances versus Voltage

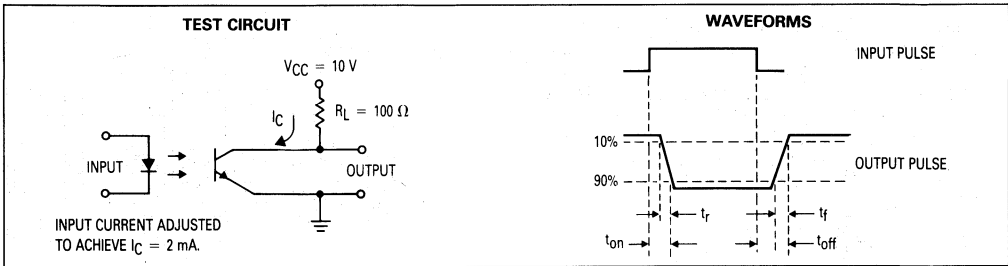
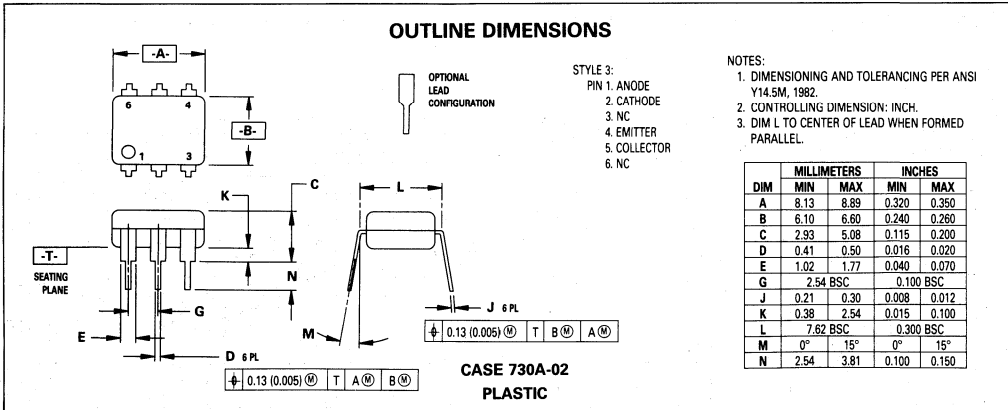





Figure 10. Switching Times



6

6-Pin DIP Optoisolators Transistor Output

... consist of gallium-arsenide infrared emitting diodes optically coupled to high voltage, silicon, phototransistor detectors in a standard 6-pin DIP package. They are designed for applications requiring high voltage output and are particularly useful in copy machines and solid state relays.

- Convenient Plastic Dual-in-Line Package
- High Input-Output Isolation Guaranteed — 7500 Volts Peak
- UL Recognized. File Number E54915 
- VDE approved per standard 0883/6.80 (Certificate number 41853), with additional approval to DIN IEC380/VDE0806, IEC435/VDE0805, IEC65/VDE0860, VDE0110b, covering all other standards with equal or less stringent requirements, including IEC204/VDE0113, VDE0160, VDE0832, VDE0833, etc. 
- No Base Connection for Improved Noise Immunity  883
- Special lead form available (add suffix "T" to part number) which satisfies VDE0883/6.80 requirement for 8 mm minimum creepage distance between input and output solder pads.
- Various lead form options available. Consult "Optoisolator Lead Form Options" data sheet for details.

MOC8204
MOC8205
MOC8206

**6-PIN DIP
 OPTOISOLATORS
 TRANSISTOR OUTPUT
 400 VOLTS**

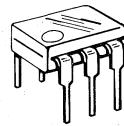

**CASE 730A-02
 PLASTIC**

MAXIMUM RATINGS ($T_A = 25^\circ\text{C}$ unless otherwise noted)

| Rating | Symbol | Value | Unit |
|--------|--------|-------|------|
|--------|--------|-------|------|

INPUT LED

| | | | |
|---|-------|-------------|-------------|
| Forward Current — Continuous | I_F | 60 | mA |
| Forward Current — Peak Pulse Width = 1 μs , 330 pps | I_F | 1.2 | Amp |
| LED Power Dissipation @ $T_A = 25^\circ\text{C}$ Derate above 25°C | P_D | 120 1.41 | mW mW/°C |

OUTPUT TRANSISTOR

| | | | |
|--|-----------|-------------|-------------|
| Collector-Emitter Voltage | V_{CER} | 400 | Volts |
| Emitter-Collector Voltage | V_{ECO} | 7 | Volts |
| Collector-Base Voltage | V_{CBO} | 400 | Volts |
| Collector Current (Continuous) | I_C | 100 | mA |
| Detector Power Dissipation @ $T_A = 25^\circ\text{C}$ Derate above 25°C | P_D | 150 1.76 | mW mW/°C |

TOTAL DEVICE

| | | | |
|--|-----------|-------------|-------------|
| Total Device Power Dissipation @ $T_A = 25^\circ\text{C}$ Derate above 25°C | P_D | 250 2.94 | mW mW/°C |
| Operating Temperature Range | T_J | -55 to +100 | °C |
| Storage Temperature Range | T_{stg} | -55 to +150 | °C |
| Soldering Temperature (10 s) | — | 260 | °C |
| Isolation Surge Voltage Peak ac Voltage, 60 Hz, 1 Second Duration (1) | V_{ISO} | 7500 | Vac(pk) |

(1) Isolation surge voltage is an internal device dielectric breakdown rating.

SCHEMATIC

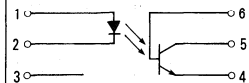

1. ANODE
2. CATHODE
3. NC
4. EMITTER
5. COLLECTOR
6. BASE

MOC8204, MOC8205, MOC8206

ELECTRICAL CHARACTERISTICS

| Characteristic | Symbol | Min | Typ | Max | Unit |
|----------------|--------|-----|-----|-----|------|
|----------------|--------|-----|-----|-----|------|

INPUT LED ($T_A = 25^\circ\text{C}$ unless otherwise noted)

| | | | | | |
|---|-------|---|-----|-----|---------------|
| Reverse Leakage Current ($V_R = 6\text{ V}$) | I_R | — | — | 10 | μA |
| Forward Voltage ($I_F = 10\text{ mA}$) | V_F | — | 1.2 | 1.5 | Volts |
| Capacitance ($V = 0\text{ V}, f = 1\text{ MHz}$) | C_J | — | 18 | — | pF |

OUTPUT TRANSISTOR ($T_A = 25^\circ\text{C}$ and $I_F = 0$ unless otherwise noted)

| | | | | | |
|---|---------------|---------------------------|---|-----|---------------|
| Collector-Emitter Dark Current ($R_{BE} = 1\text{ M}\Omega$) ($V_{CE} = 300\text{ V}$) | I_{CER} | — | — | 100 | nA |
| | | $T_A = 25^\circ\text{C}$ | — | 250 | μA |
| | | $T_A = 100^\circ\text{C}$ | — | — | — |
| Collector-Base Breakdown Voltage ($I_C = 100\text{ }\mu\text{A}$) | $V_{(BR)CBO}$ | 400 | — | — | Volts |
| Collector-Emitter Breakdown Voltage ($I_C = 1\text{ mA}, R_{BE} = 1\text{ M}\Omega$) | $V_{(BR)CER}$ | 400 | — | — | Volts |
| Emitter-Base Breakdown Voltage ($I_E = 100\text{ }\mu\text{A}$) | $V_{(BR)EBO}$ | 7 | — | — | Volts |

COUPLED ($T_A = 25^\circ\text{C}$ unless otherwise noted)

| | | | | | |
|--|---------------|--|-----------|-----|---------------|
| Current Transfer Ratio ($V_{CE} = 10\text{ V}, I_F = 10\text{ mA}, R_{BE} = 1\text{ M}\Omega$) | CTR | | | | % |
| | | MOC8204 | 20 | — | — |
| | | MOC8205 | 10 | — | — |
| | | MOC8206 | 5 | — | — |
| Surge Isolation Voltage (Input to Output) (1) Peak ac Voltage, 60 Hz, 1 sec | V_{ISO} | 7500 | — | — | Volts |
| Isolation Resistance (1) ($V = 500\text{ V}$) | R_{ISO} | — | 10^{11} | — | Ohms |
| Collector-Emitter Saturation Voltage ($I_C = 0.5\text{ mA}, I_F = 10\text{ mA}, R_{BE} = 1\text{ M}\Omega$) | $V_{CE(sat)}$ | — | — | 0.4 | Volts |
| Isolation Capacitance (1) ($V = 0\text{ V}, f = 1\text{ MHz}$) | C_{ISO} | — | 0.2 | — | pF |
| Turn-On Time | t_{on} | $V_{CC} = 10\text{ V}, I_C = 2\text{ mA}, R_L = 100\text{ }\Omega$ | — | 5 | μs |
| Turn-Off Time | t_{off} | | — | 5 | |

NOTE: 1. For this test LED Pins 1 and 2 are common and phototransistor Pins 4, 5, and 6 are common.

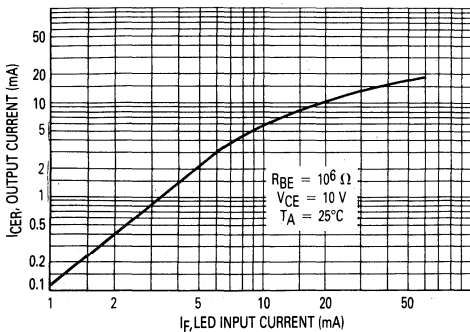

Figure 1. Output Current versus LED Input Current

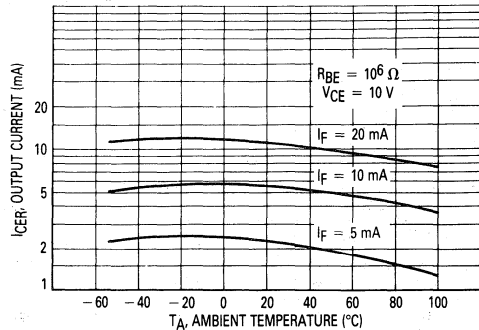

Figure 2. Output Current versus Temperature

MOC8204, MOC8205, MOC8206

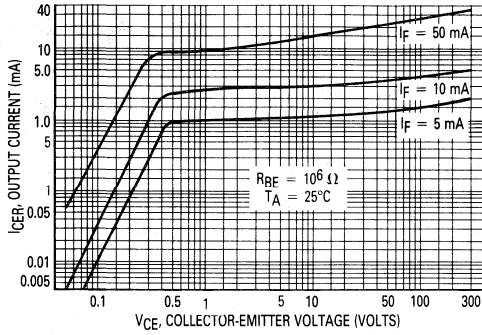

Figure 3. Output Characteristics

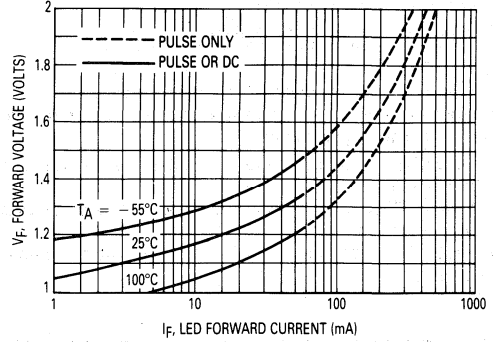

Figure 4. Forward Characteristics

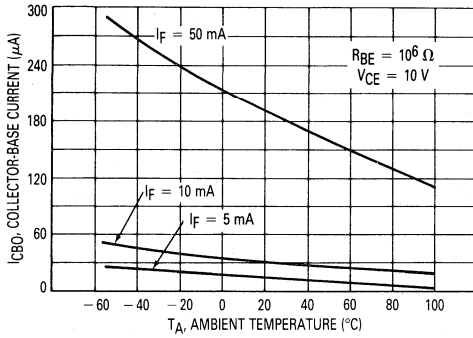

Figure 5. Collector-Base Current versus Temperature

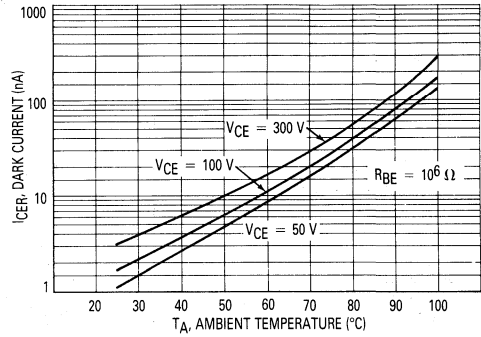
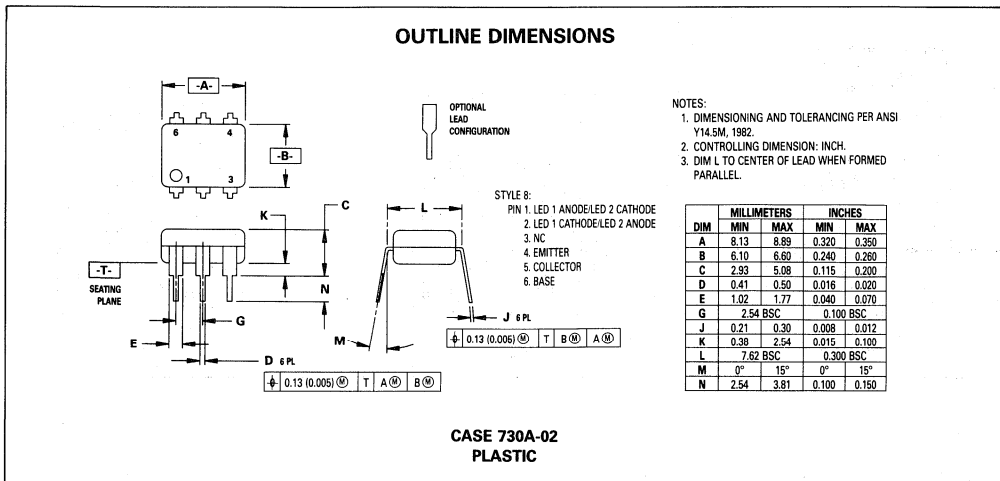

Figure 6. Dark Current versus Temperature



Optoisolator Lead Form Options

All Motorola 6-pin dual-in-line optoisolators are available in either a surface-mountable gull-wing lead form or a wide-spaced 0.400" lead form, which is used to satisfy 8 mm pc board spacing requirements.

- Attach "R" to any Motorola 6-pin dual-in-line part number for surface-mountable butt-lead option.
- Attach "S" to any Motorola 6-pin dual-in-line part number for surface-mountable gull-wing lead form.
- Attach "T" to any Motorola 6-pin dual-in-line part number for wide-spaced 0.400" lead form.

Suffix R
Suffix S
Suffix T

**OPTOISOLATOR
LEAD FORM
OPTIONS**

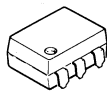

R

**Surface-mountable
butt-lead option**

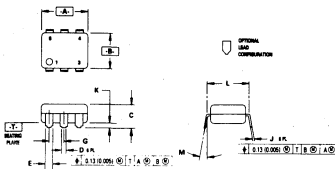

NOTES:

1. DIMENSIONS "A" AND "B" ARE DATUMS.
2. DIMENSION "L" TO CENTER OF LEADS WHEN FORMED PARALLEL.
3. DIMENSIONING AND TOLERANCING PER ANSI Y14.5M, 1982.
4. CONTROLLING DIMENSION: INCH.

| DIM | MILLIMETERS | | INCHES | |
|-----|-------------|------|-----------|-------|
| | MIN | MAX | MIN | MAX |
| A | 8.13 | 8.89 | 0.320 | 0.350 |
| B | 6.10 | 6.60 | 0.240 | 0.260 |
| C | 2.93 | 5.08 | 0.115 | 0.200 |
| D | 0.41 | 0.50 | 0.016 | 0.020 |
| E | 1.02 | 1.77 | 0.040 | 0.070 |
| G | 2.54 BSC | | 0.100 BSC | |
| J | 0.20 | 0.30 | 0.008 | 0.012 |
| K | 0.51 | 0.63 | 0.020 | 0.025 |
| L | 7.62 BSC | | 0.300 BSC | |
| M | 0° | 15° | 0° | 15° |

730B-02

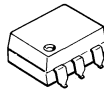

S

**Surface-mountable
gull-wing option**

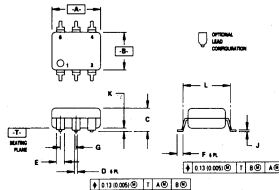

NOTES:

1. DIMENSIONING AND TOLERANCING PER ANSI Y14.5M, 1982.
2. CONTROLLING DIMENSION: INCH.

| DIM | MILLIMETERS | | INCHES | |
|-----|-------------|------|-----------|-------|
| | MIN | MAX | MIN | MAX |
| A | 8.13 | 8.89 | 0.320 | 0.350 |
| B | 6.10 | 6.60 | 0.240 | 0.260 |
| C | 2.93 | 5.08 | 0.115 | 0.200 |
| D | 0.41 | 0.50 | 0.016 | 0.020 |
| E | 1.02 | 1.77 | 0.040 | 0.070 |
| F | 0.16 | 0.86 | 0.006 | 0.035 |
| G | 2.54 BSC | | 0.100 BSC | |
| J | 0.20 | 0.30 | 0.008 | 0.012 |
| K | 0.51 | 0.63 | 0.020 | 0.025 |
| L | 8.13 BSC | | 0.320 BSC | |

730C-02

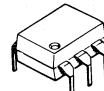

T

**Wide-spaced (0.400")
lead form option**

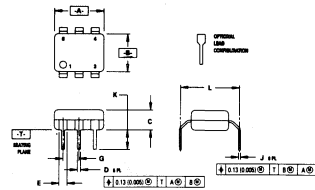

NOTES:

1. DIMENSIONING AND TOLERANCING PER ANSI Y14.5M, 1982.
2. CONTROLLING DIMENSION: INCH.
3. DIM L TO CENTER OF LEAD WHEN FORMED PARALLEL.

| DIM | MILLIMETERS | | INCHES | |
|-----|-------------|------|-----------|-------|
| | MIN | MAX | MIN | MAX |
| A | 8.13 | 8.89 | 0.320 | 0.350 |
| B | 6.10 | 6.60 | 0.240 | 0.260 |
| C | 2.42 | 4.44 | 0.095 | 0.175 |
| D | 0.41 | 0.50 | 0.016 | 0.020 |
| E | 1.02 | 1.77 | 0.040 | 0.070 |
| G | 2.54 BSC | | 0.100 BSC | |
| J | 0.20 | 0.30 | 0.008 | 0.012 |
| K | 3.38 | — | 0.133 | — |
| L | 10.16 BSC | | 0.400 BSC | |

730D-02

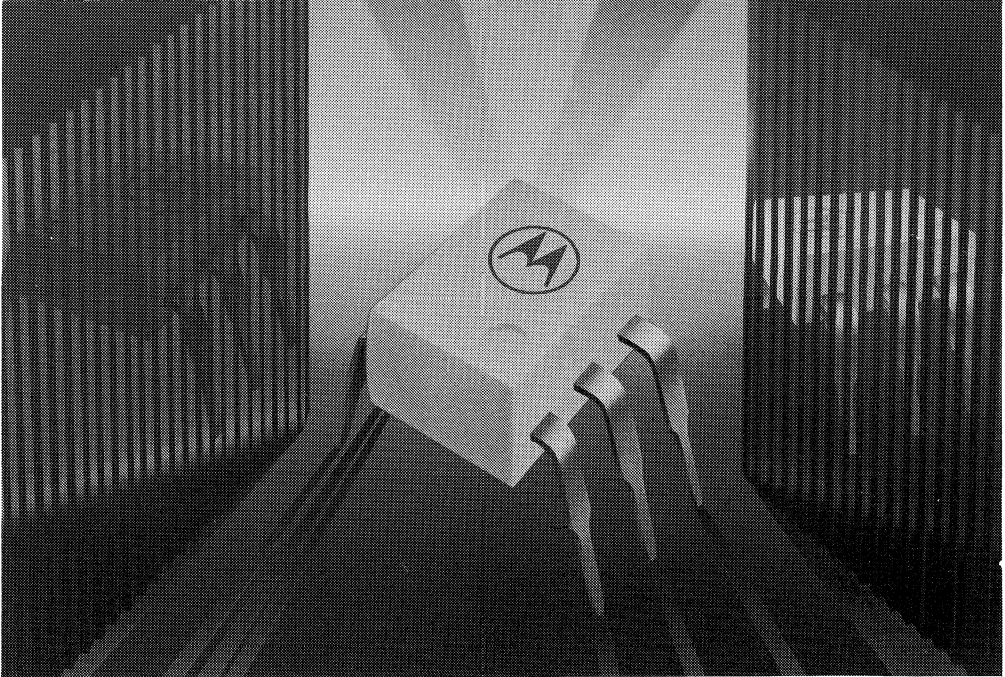

Slotted Optical Switches Data Sheets

7

Slotted Optical Switches Transistor Output

Each device consists of a gallium arsenide infrared emitting diode facing a silicon NPN phototransistor in a molded plastic housing. A slot in the housing between the emitter and the detector provides the means for mechanically interrupting the infrared beam. These devices are widely used as position sensors in a variety of applications.

- Single Unit for Easy PCB Mounting
- Non-Contact Electrical Switching
- Long-Life Liquid Phase Epi Emitter
- 1 mm Detector Aperture Width

MAXIMUM RATINGS

| Rating | Symbol | Value | Unit |
|--------|--------|-------|------|
|--------|--------|-------|------|

INPUT LED

| | | | |
|---|-------|----------|----------------------------|
| Reverse Voltage | V_R | 6 | Volts |
| Forward Current — Continuous | I_F | 60 | mA |
| Input LED Power Dissipation @ $T_A = 25^\circ\text{C}$ Derate above 25°C | P_D | 150 2 | mW mW/ $^\circ\text{C}$ |

OUTPUT TRANSISTOR

| | | | |
|---|-----------|----------|----------------------------|
| Collector-Emitter Voltage | V_{CEO} | 30 | Volts |
| Output Current — Continuous | I_C | 100 | mA |
| Output Transistor Power Dissipation @ $T_A = 25^\circ\text{C}$ Derate above 25°C | P_D | 150 2 | mW mW/ $^\circ\text{C}$ |

TOTAL DEVICE

| | | | |
|--|-----------|-------------|----------------------------|
| Ambient Operating Temperature Range | T_A | -55 to +100 | $^\circ\text{C}$ |
| Storage Temperature | T_{stg} | -55 to +100 | $^\circ\text{C}$ |
| Lead Soldering Temperature (5 seconds max) | — | 260 | $^\circ\text{C}$ |
| Total Device Power Dissipation @ $T_A = 25^\circ\text{C}$ Derate above 25°C | P_D | 300 4 | mW mW/ $^\circ\text{C}$ |

H21A1
H21A2
H21A3
H22A1
H22A2
H22A3

**SLOTTED
 OPTICAL SWITCHES
 TRANSISTOR OUTPUT**

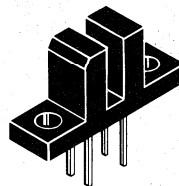

**H21A1, 2 AND 3
 CASE 354A-01**



**H22A1, 2 AND 3
 CASE 354-02**



H21A1, H21A2, H21A3, H22A1, H22A2, H22A3

ELECTRICAL CHARACTERISTICS ($T_A = 25^\circ\text{C}$ unless otherwise noted)

| Characteristic | Symbol | Min | Typ | Max | Unit |
|----------------|--------|-----|-----|-----|------|
|----------------|--------|-----|-----|-----|------|

INPUT LED

| | | | | | |
|---|-------|-----|------|-----|---------------|
| Forward Voltage ($I_F = 60\text{ mA}$) | V_F | 0.9 | 1.34 | 1.7 | Volts |
| Reverse Leakage ($V_R = 6\text{ V}$) | I_R | — | 1 | 10 | μA |
| Capacitance ($V = 0\text{ V}$, $f = 1\text{ MHz}$) | C_J | — | 18 | — | pF |

OUTPUT TRANSISTOR

| | | | | | |
|--|---------------|----|-----|-----|-------|
| Dark Current ($V_{CE} = 25\text{ V}$) | I_{CEO} | — | 15 | 100 | nA |
| Collector-Emitter Breakdown Voltage ($I_C = 1\text{ mA}$) | $V_{(BR)CEO}$ | 30 | 45 | — | Volts |
| Emitter-Collector Breakdown Voltage ($I_E = 100\ \mu\text{A}$) | $V_{(BR)ECO}$ | 6 | 7.8 | — | Volts |
| Capacitance ($V_{CE} = 5\text{ V}$, $f = 1\text{ MHz}$) | C_{CE} | — | 2.5 | — | pF |
| DC Current Gain ($V_{CE} = 5\text{ V}$, $I_C = 2\text{ mA}$) | h_{FE} | — | 700 | — | — |

COUPLED

| | | | | | | |
|--|--------------|---------------|------|------|-----|---------------|
| Output Collector Current ($I_F = 5\text{ mA}$, $V_{CE} = 5\text{ V}$) Note 1 | H21A1, H22A1 | I_C | 0.15 | 0.3 | — | mA |
| | H21A2, H22A2 | | 0.3 | 0.6 | — | |
| | H21A3, H22A3 | | 0.6 | 1 | — | |
| Output Collector Current ($I_F = 20\text{ mA}$, $V_{CE} = 5\text{ V}$) Note 1 | H21A1, H22A1 | I_C | 1 | 2 | — | mA |
| | H21A2, H22A2 | | 2 | 4 | — | |
| | H21A3, H22A3 | | 4 | 7 | — | |
| Output Collector Current ($I_F = 30\text{ mA}$, $V_{CE} = 5\text{ V}$) Note 1 | H21A1, H22A1 | I_C | 1.9 | 3.8 | — | mA |
| | H21A2, H22A2 | | 3 | 6 | — | |
| | H21A3, H22A3 | | 5.5 | 10 | — | |
| Collector-Emitter Saturation Voltage ($I_C = 1.8\text{ mA}$, $I_F = 30\text{ mA}$) Note 1 | H21A1, H22A1 | $V_{CE(sat)}$ | — | 0.25 | 0.4 | Volts |
| Collector-Emitter Saturation Voltage ($I_C = 1.8\text{ mA}$, $I_F = 20\text{ mA}$) Note 1 | H21A2, H22A2 | | — | 0.25 | 0.4 | |
| | H21A3, H22A3 | | — | 0.25 | 0.4 | |
| Turn-On Time ($I_F = 30\text{ mA}$, $V_{CC} = 5\text{ V}$, $R_L = 2.5\text{ k}\Omega$) Note 1 | | t_{on} | — | 20 | — | μs |
| Turn-Off Time ($I_F = 30\text{ mA}$, $V_{CC} = 5\text{ V}$, $R_L = 2.5\text{ k}\Omega$) Note 1 | | t_{off} | — | 80 | — | μs |

Notes: 1. No actuator in sensing gap.

2. Stray radiation can alter values of characteristics. Adequate light shielding should be provided.

TYPICAL CHARACTERISTICS

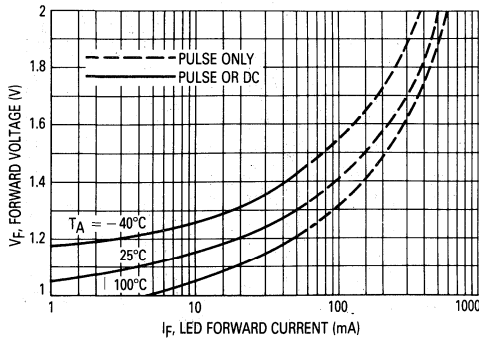

Figure 1. LED Forward Voltage versus Forward Current

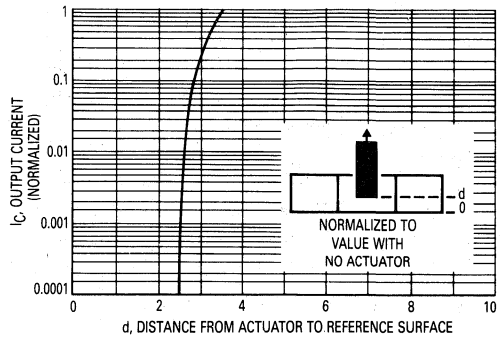

Figure 2. Output Current versus Actuator Position

H21A1, H21A2, H21A3, H22A1, H22A2, H22A3

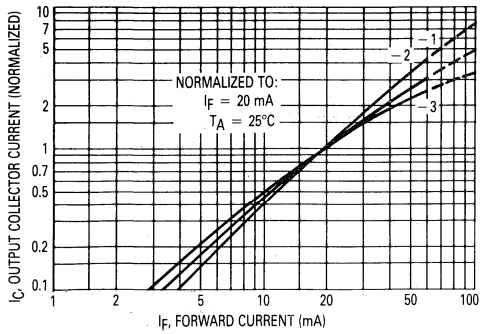

Figure 3. Output Current versus Input Current

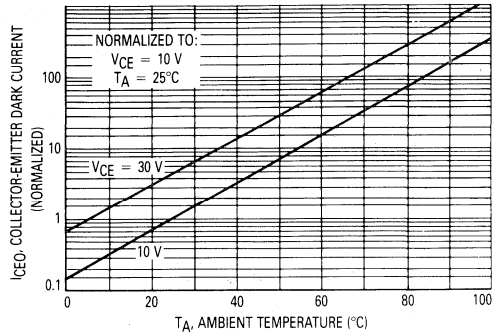

Figure 4. Dark Current versus Ambient Temperature

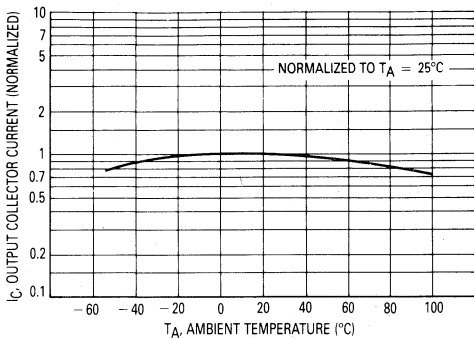

Figure 5. Output Current versus Ambient Temperature

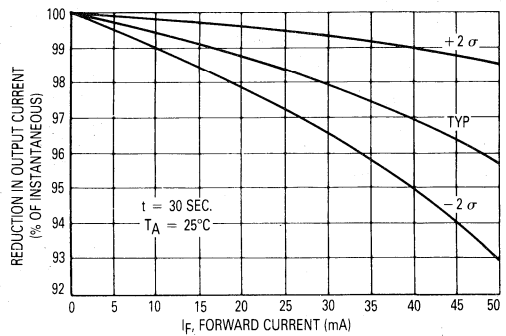

Figure 6. Reduction in Output Current Due to LED Heating versus Forward Current

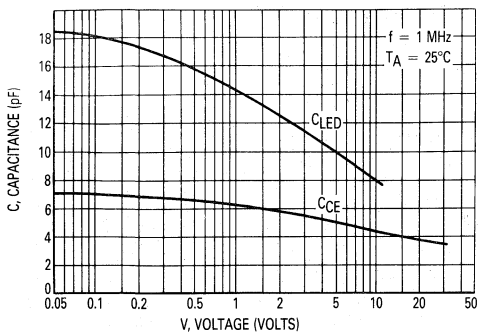

Figure 7. Capacitances versus Voltage

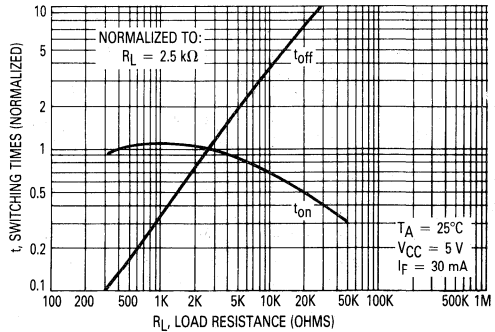

Figure 8. Switching Times versus Load Resistance

H21A1, H21A2, H21A3, H22A1, H22A2, H22A3

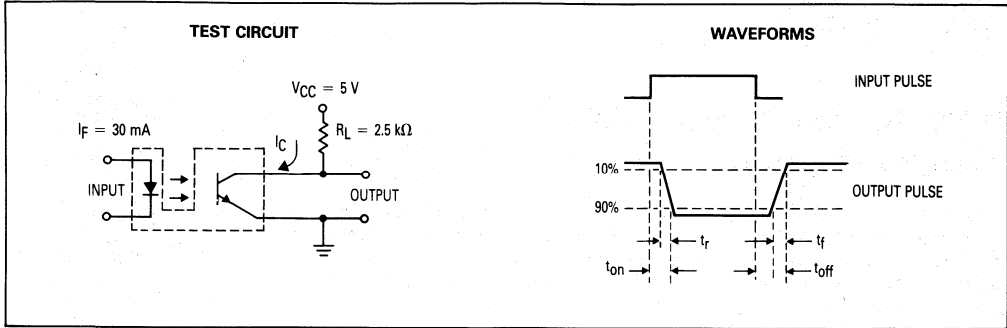
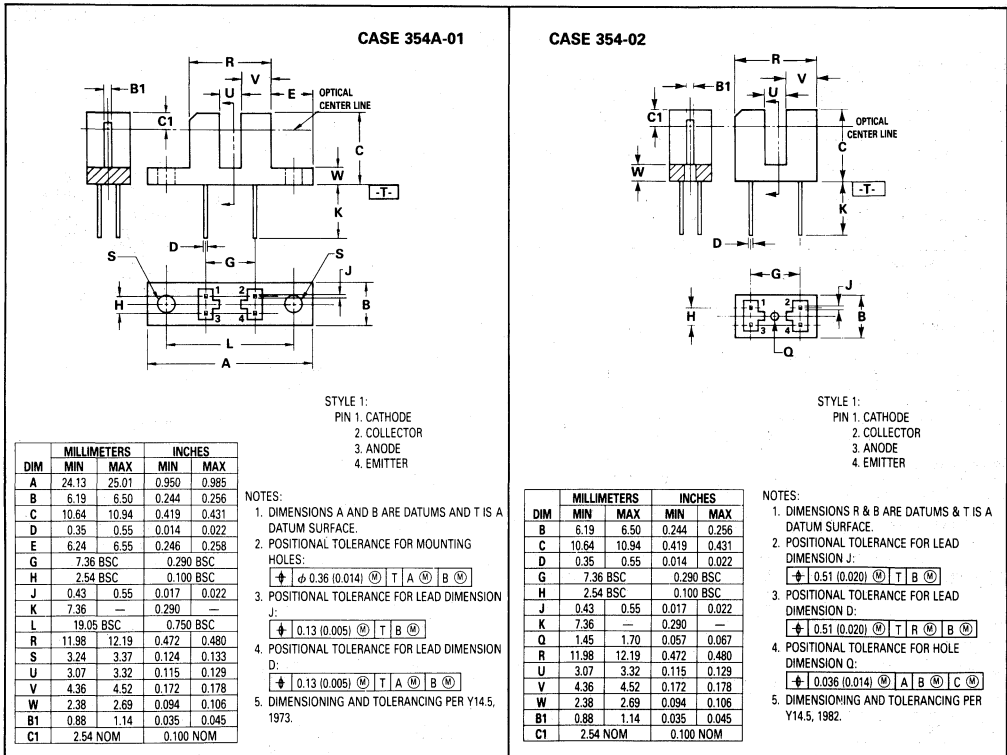

Figure 9. Switching Times

OUTLINE DIMENSIONS



B1

MOTOROLA
SEMICONDUCTOR
TECHNICAL DATA

Slotted Optical Switches
Darlington Output

These devices each consist of a gallium arsenide infrared emitting diode facing a silicon NPN photodarlington in a molded plastic housing. A slot in the housing between the emitter and the detector provides the means for mechanically interrupting the infrared beam. These devices are widely used as position sensors in a variety of applications.

- Single Unit for Easy PCB Mounting
- Non-Contact Electrical Switching
- Long-Life Liquid Phase Epi Emitter
- 1 mm Detector Aperture Width

MAXIMUM RATINGS

| Rating | Symbol | Value | Unit |
|---|-----------|----------|-------------|
| INPUT LED | | | |
| Reverse Voltage | V_R | 6 | Volts |
| Forward Current — Continuous | I_F | 60 | mA |
| Input LED Power Dissipation @ $T_A = 25^\circ\text{C}$ Derate above 25°C | P_D | 150 2 | mW mW/°C |
| OUTPUT DARLINGTON | | | |
| Collector-Emitter Voltage | V_{CEO} | 30 | Volts |
| Output Current — Continuous | I_C | 100 | mA |
| Output Darlington Power Dissipation @ $T_A = 25^\circ\text{C}$ Derate above 25°C | P_D | 150 2 | mW mW/°C |

TOTAL DEVICE

| | | | |
|--|-----------|-------------|-------------|
| Ambient Operating Temperature Range | T_A | -55 to +100 | °C |
| Storage Temperature | T_{stg} | -55 to +100 | °C |
| Lead Soldering Temperature (5 seconds max) | — | 260 | °C |
| Total Device Power Dissipation @ $T_A = 25^\circ\text{C}$ Derate above 25°C | P_D | 300 4 | mW mW/°C |

ELECTRICAL CHARACTERISTICS ($T_A = 25^\circ\text{C}$ unless otherwise noted)

| Characteristic | Symbol | Min | Typ | Max | Unit |
|--|--------|-----|------|-----|---------------|
| INPUT LED | | | | | |
| Forward Voltage ($I_F = 60\text{ mA}$) | V_F | 0.9 | 1.34 | 1.7 | Volts |
| Reverse Leakage ($V_R = 6\text{ V}$) | I_R | — | 1 | 10 | μA |
| Capacitance ($V = 0\text{ V}, f = 1\text{ MHz}$) | C_J | — | 18 | — | pF |

(continued)

H21B1
H21B2
^A **H21B3**

H22B1
H22B2
H22B3

SLOTTED
OPTICAL SWITCHES
DARLINGTON OUTPUT

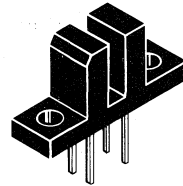

H21B1, 2 AND 3
CASE 354A-01

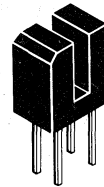

H22B1, 2 AND 3
CASE 354-02

7

H21B1, H21B2, H21B3, H22B1, H22B2, H22B3

ELECTRICAL CHARACTERISTICS — continued ($T_A = 25^\circ\text{C}$ unless otherwise noted)

| Characteristic | Symbol | Min | Typ | Max | Unit |
|--|---------------|-----|--------|-----|-------|
| OUTPUT DARLINGTON | | | | | |
| Dark Current ($V_{CE} = 25\text{ V}$) | I_{CEO} | — | 10 | 100 | nA |
| Collector-Emitter Breakdown Voltage ($I_C = 1\text{ mA}$) | $V_{(BR)CEO}$ | 30 | 90 | — | Volts |
| Emitter-Collector Breakdown Voltage ($I_E = 100\ \mu\text{A}$) | $V_{(BR)ECO}$ | 7 | — | — | Volts |
| Capacitance ($V_{CE} = 5\text{ V}$, $f = 1\text{ MHz}$) | C_{CE} | — | 4 | — | pF |
| DC Current Gain ($V_{CE} = 10\text{ V}$, $I_C = 2\text{ mA}$) | h_{FE} | — | 10,000 | — | — |

COUPLED (Note 1)

| | | | | | | |
|--|--------------|---------------|-----|-----|-----|---------------|
| Output Collector Current ($I_F = 2\text{ mA}$, $V_{CE} = 1.5\text{ V}$) | H21B1, H22B1 | I_C | 0.5 | 1 | — | mA |
| | H21B2, H22B2 | | 1 | 2 | — | |
| | H21B3, H22B3 | | 2 | 3.8 | — | |
| Output Collector Current ($I_F = 5\text{ mA}$, $V_{CE} = 1.5\text{ V}$) | H21B1, H22B1 | I_C | 2.5 | 5 | — | mA |
| | H21B2, H22B2 | | 5 | 10 | — | |
| | H21B3, H22B3 | | 10 | 18 | — | |
| Output Collector Current ($I_F = 10\text{ mA}$, $V_{CE} = 1.5\text{ V}$) | H21B1, H22B1 | I_C | 7.5 | 15 | — | mA |
| | H21B2, H22B2 | | 14 | 28 | — | |
| | H21B3, H22B3 | | 25 | 40 | — | |
| Collector-Emitter Saturation Voltage ($I_C = 1.8\text{ mA}$, $I_F = 10\text{ mA}$) | | $V_{CE(sat)}$ | — | — | 1 | Volts |
| Collector-Emitter Saturation Voltage ($I_C = 50\text{ mA}$, $I_F = 60\text{ mA}$) | H21B2, H22B2 | $V_{CE(sat)}$ | — | — | 1.5 | Volts |
| | H21B3, H22B3 | | — | — | 1.5 | |
| Turn-On Time ($I_F = 10\text{ mA}$, $V_{CC} = 5\text{ V}$, $R_L = 510\ \Omega$) | | t_{on} | — | 120 | — | μs |
| Turn-Off Time ($I_F = 10\text{ mA}$, $V_{CC} = 5\text{ V}$, $R_L = 510\ \Omega$) | | t_{off} | — | 500 | — | μs |

Notes: 1. Stray radiation can alter values of characteristics. Adequate light shielding should be provided.
2. No actuator in sensing gap.

TYPICAL CHARACTERISTICS

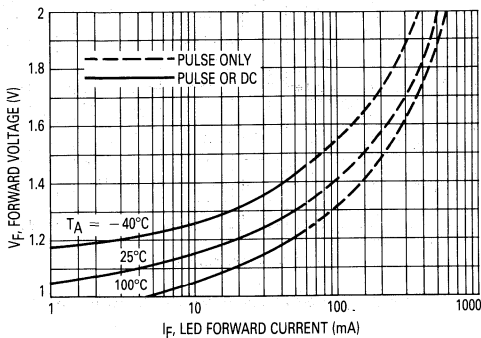

Figure 1. LED Forward Voltage versus Forward Current

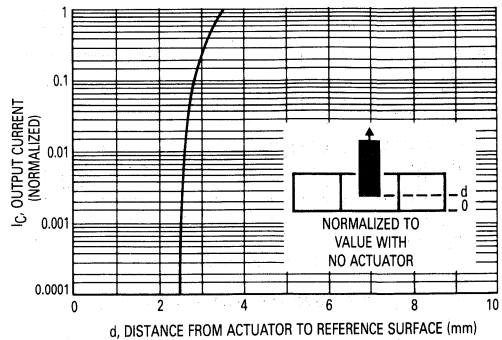

Figure 2. Output Current versus Actuator Position

H21B1, H21B2, H21B3, H22B1, H22B2, H22B3

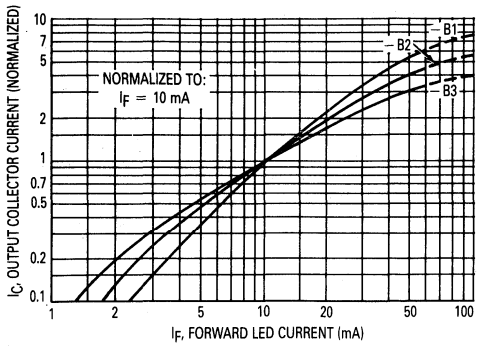

Figure 3. Output Current versus Input Current

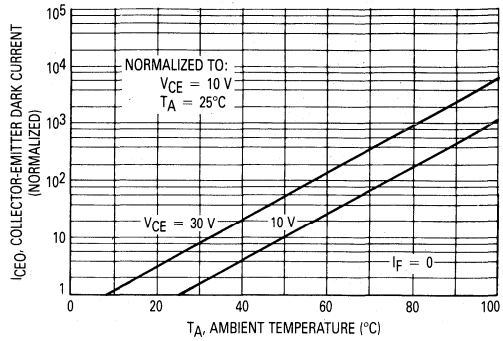

Figure 4. Collector-Emitter Dark Current versus Ambient Temperature

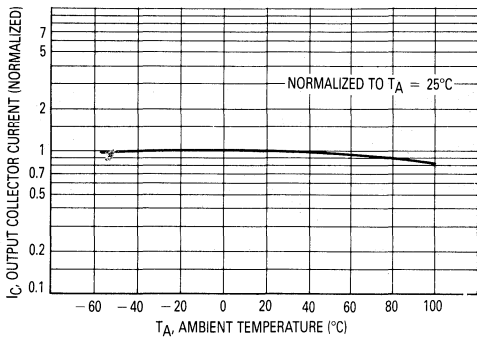

Figure 5. Output Current versus Ambient Temperature

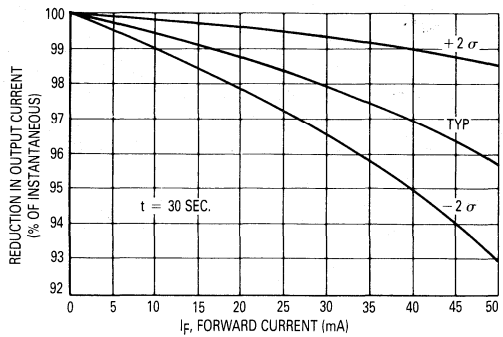

Figure 6. Reduction in Output Current Due to LED Heating versus Forward Current

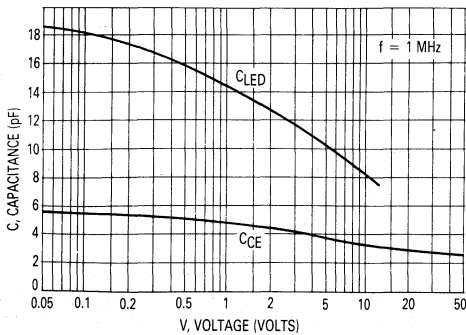

Figure 7. Capacitances versus Voltage

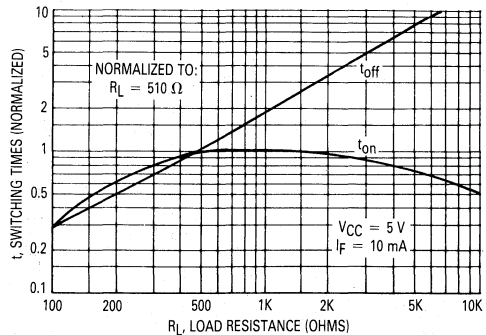

Figure 8. Switching Times versus Load Resistance

H21B1, H21B2, H21B3, H22B1, H22B2, H22B3

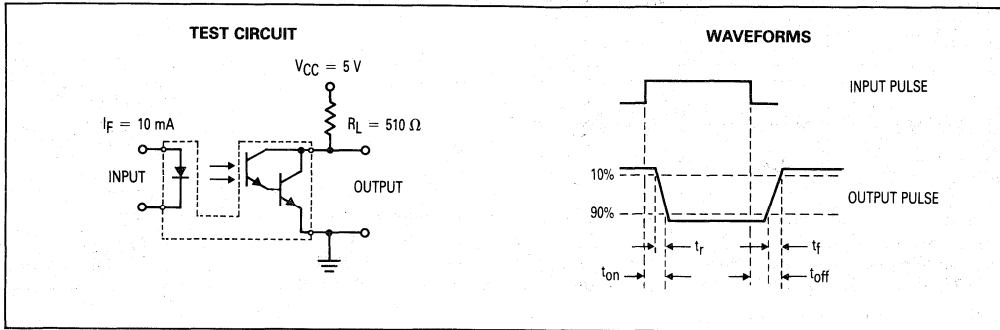
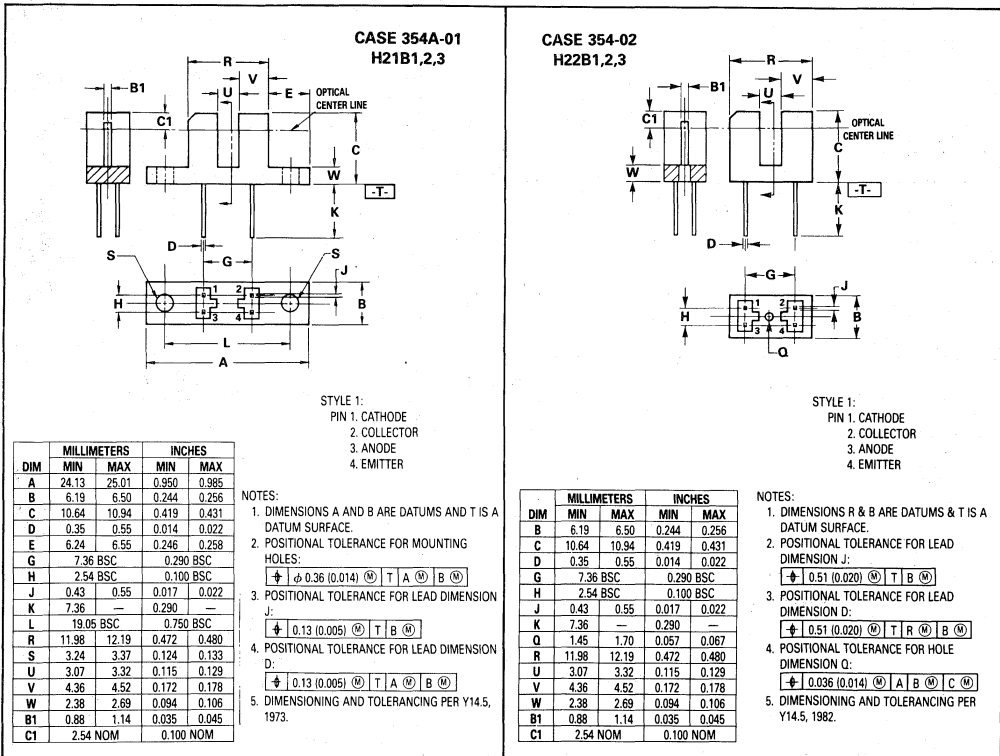

Figure 9. Switching Times

OUTLINE DIMENSIONS



Slotted Optical Switches Transistor Output

These devices each consist of a gallium arsenide infrared emitting diode facing a silicon NPN phototransistor in a molded plastic housing. A slot in the housing between the emitter and the detector provides the means for mechanically interrupting the infrared beam. These devices are widely used as position sensors in a variety of applications.

- Single Unit for Easy PCB Mounting
- Non-Contact Electrical Switching
- Long-Life Liquid Phase Epi Emitter
- Several Convenient Package Styles

MAXIMUM RATINGS

| Rating | Symbol | Value | Unit |
|--------|--------|-------|------|
|--------|--------|-------|------|

INPUT LED

| | | | |
|--|-------|----------|----------------------------|
| Reverse Voltage | V_R | 6 | Volts |
| Forward Current — Continuous | I_F | 60 | mA |
| Input Transistor Power Dissipation @ $T_A = 25^\circ\text{C}$ Derate above 25°C | P_D | 150 2 | mW mW/ $^\circ\text{C}$ |

OUTPUT TRANSISTOR

| | | | |
|---|-----------|----------|----------------------------|
| Collector-Emitter Voltage | V_{CEO} | 30 | Volts |
| Output Current — Continuous | I_C | 100 | mA |
| Output Transistor Power Dissipation @ $T_A = 25^\circ\text{C}$ Derate above 25°C | P_D | 150 2 | mW mW/ $^\circ\text{C}$ |

TOTAL DEVICE

| | | | |
|--|-----------|-------------|----------------------------|
| Ambient Operating Temperature Range | T_A | -40 to +100 | $^\circ\text{C}$ |
| Storage Temperature | T_{stg} | -40 to +100 | $^\circ\text{C}$ |
| Lead Soldering Temperature (5 seconds max) | — | 260 | $^\circ\text{C}$ |
| Total Device Power Dissipation @ $T_A = 25^\circ\text{C}$ Derate above 25°C | P_D | 300 4 | mW mW/ $^\circ\text{C}$ |

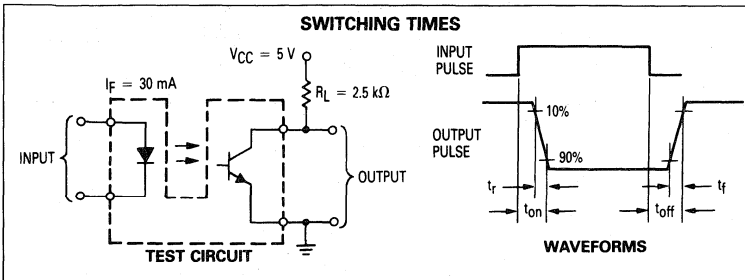

MOC70 Series

SLOTTED OPTICAL SWITCHES TRANSISTOR OUTPUT

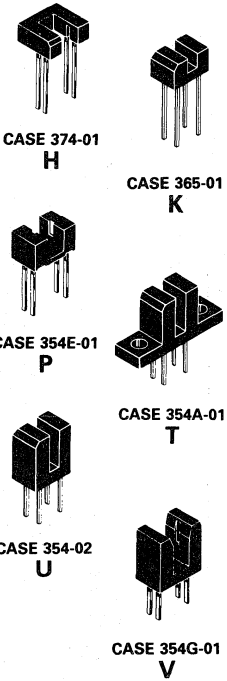

PART NUMBER DERIVATION

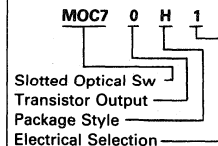

MOC70 Series

ELECTRICAL CHARACTERISTICS (T_A = 25°C unless otherwise noted. Note 1.)

| Characteristic | Symbol | Min | Typ | Max | Unit |
|--|----------------|-----|-----|-----|-------|
| INPUT LED | | | | | |
| Forward Voltage (I _F = 50 mA) | V _F | 0.9 | 1.3 | 1.8 | Volts |
| Reverse Leakage (V _R = 6 V) | I _R | — | 1 | 100 | μA |
| Capacitance (V = 0 V, f = 1 MHz) | C _J | — | 18 | — | pF |

OUTPUT TRANSISTOR

| | | | | | |
|---|----------------------|----|-----|-----|-------|
| Dark Current (V _{CE} = 10 V) | I _{CEO} | — | 5 | 100 | nA |
| Collector-Emitter Breakdown Voltage (I _C = 10 mA) | V _{(BR)CEO} | 30 | 45 | — | Volts |
| Emitter-Collector Breakdown Voltage (I _E = 100 μA) | V _{(BR)ECO} | 5 | 7 | — | Volts |
| DC Current Gain (V _{CE} = 10 V, I _C = 2 mA) | h _{FE} | — | 700 | — | — |

COUPLED (Note 2)

| | | | | | | |
|---|---------|----------------------|------|------|-----|-------|
| Output Collector Current (I _F = 5 mA, V _{CE} = 10 V) | MOC70_1 | I _C | 0.15 | 0.3 | — | mA |
| | MOC70_2 | | 0.3 | 0.6 | — | |
| | MOC70_3 | | 0.6 | 1 | — | |
| Output Collector Current (I _F = 20 mA, V _{CE} = 10 V) | MOC70_1 | I _C | 1 | 2 | — | mA |
| | MOC70_2 | | 2 | 4 | — | |
| | MOC70_3 | | 4 | 7 | — | |
| Output Collector Current (I _F = 30 mA, V _{CE} = 10 V) | MOC70_1 | I _C | 1.9 | 3.8 | — | mA |
| | MOC70_2 | | 3 | 6 | — | |
| | MOC70_3 | | 5.5 | 10 | — | |
| Collector-Emitter Saturation Voltage (I _C = 1.8 mA, I _F = 30 mA) | MOC70_1 | V _{CE(sat)} | — | 0.25 | 0.4 | Volts |
| Collector-Emitter Saturation Voltage (I _C = 1.8 mA, I _F = 20 mA) | MOC70_2 | V _{CE(sat)} | — | 0.25 | 0.4 | Volts |
| | MOC70_3 | | — | 0.25 | 0.4 | |
| Turn-On Time (I _F = 30 mA, V _{CE} = 5 V, R _L = 2.5 kΩ) | | t _{on} | — | 20 | — | μs |
| Turn-Off Time (I _F = 30 mA, V _{CE} = 5 V, R _L = 2.5 kΩ) | | t _{off} | — | 80 | — | μs |

Notes: 1. Stray radiation can alter values of characteristics. Adequate light shielding should be provided.
2. No actuator in sensing gap.

TYPICAL CHARACTERISTICS

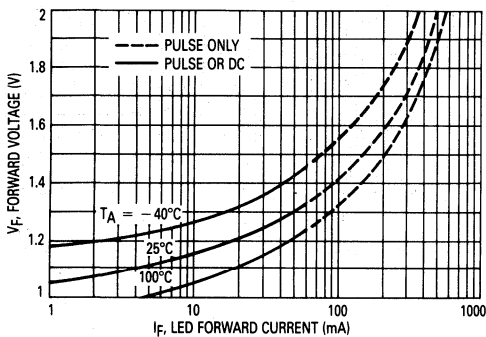

Figure 1. LED Forward Voltage versus Forward Current

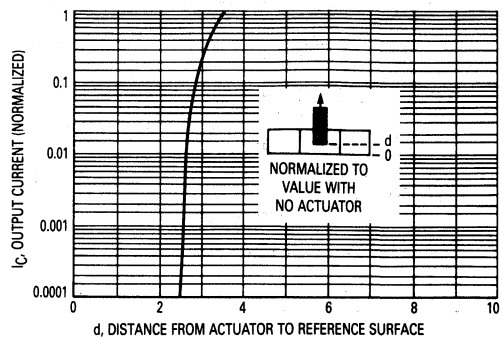

Figure 2. Output Current versus Actuator Position

MOC70 Series

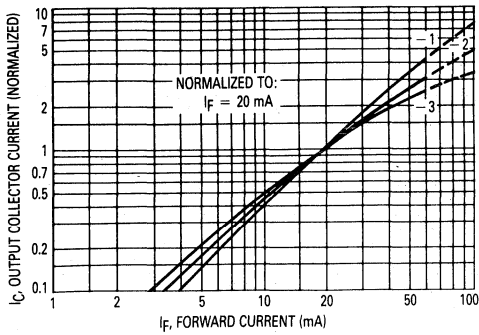

Figure 3. Output Current versus Input Current

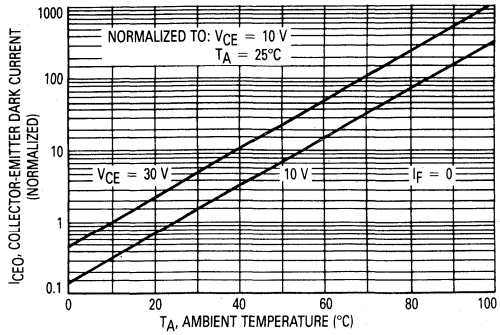

Figure 4. Dark Current versus Ambient Temperature

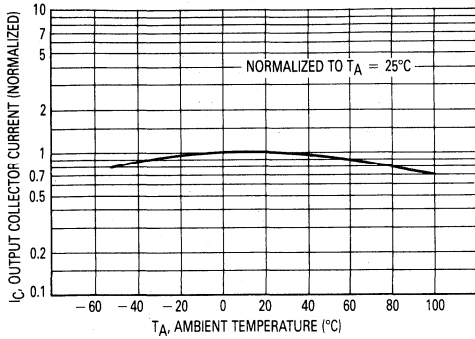

Figure 5. Output Current versus Ambient Temperature

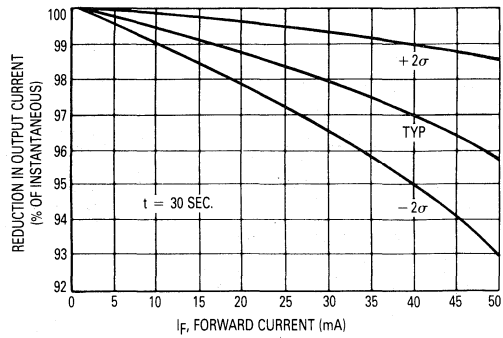

Figure 6. Reduction in Output Current Due to LED Heating versus Forward Current

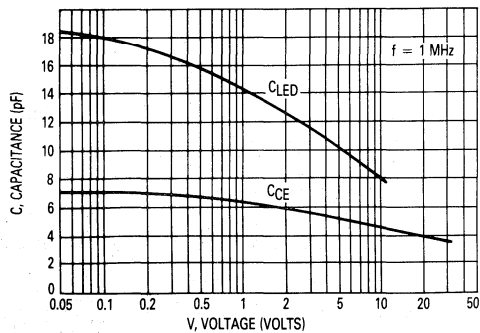

Figure 7. Capacitances versus Voltage

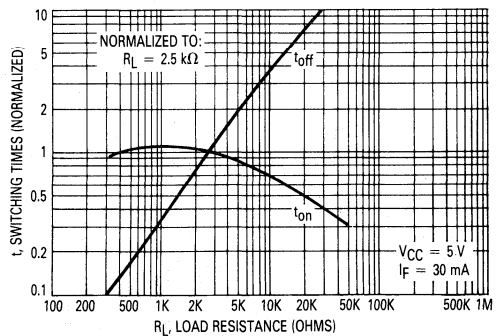
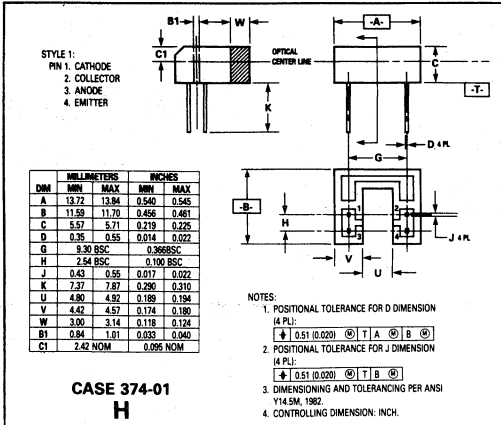

Figure 8. Switching Times versus Load Resistance

7

MOC70 Series

OUTLINE DIMENSIONS



| DIM | MIN | MAX | MIN | MAX |
|-----|-------|-------|-------|-------|
| A | 11.94 | 12.24 | 0.470 | 0.482 |
| B | 6.17 | 6.52 | 0.243 | 0.257 |
| C | 5.54 | 5.89 | 0.218 | 0.232 |
| D | 0.30 | 0.45 | 0.012 | 0.018 |
| G | 7.36 | BSC | 0.290 | BSC |
| H | 2.54 | BSC | 0.100 | BSC |
| J | 0.41 | 0.60 | 0.016 | 0.024 |
| K | 12.70 | 13.33 | 0.500 | 0.525 |
| R | 3.05 | 3.35 | 0.120 | 0.132 |
| U | 0.91 | 1.06 | 0.036 | 0.041 |
| V | 2.28 | NOM | 0.090 | NOM |
| W | 1.50 | 1.62 | 0.059 | 0.064 |

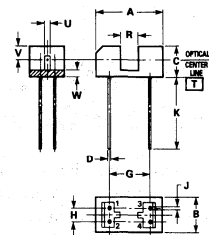

- NOTES:
- DIMENSIONS A AND B ARE DATUMS AND T IS A DATUM PLANE.
 - POSITIONAL TOLERANCE FOR LEAD DIMENSION J:
Ⓢ 0.51 (0.020) Ⓢ T | A Ⓢ B Ⓢ
 - POSITIONAL TOLERANCE FOR LEAD DIMENSION D:
Ⓢ 0.51 (0.020) Ⓢ T | A Ⓢ
 - DIMENSIONING AND TOLERANCING PER ANSI Y14.5M, 1982.
 - CONTROLLING DIMENSION: INCH.

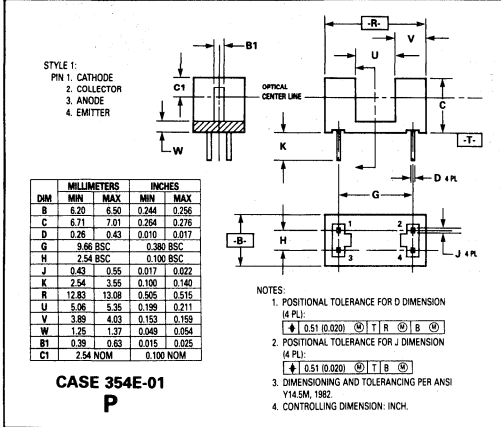

| DIM | MIN | MAX | MIN | MAX |
|-----|-------|-------|-------|-------|
| A | 24.13 | 25.01 | 0.950 | 0.985 |
| B | 6.19 | 6.50 | 0.244 | 0.256 |
| C | 10.64 | 10.94 | 0.419 | 0.431 |
| D | 0.35 | 0.55 | 0.014 | 0.022 |
| E | 6.24 | 6.56 | 0.246 | 0.258 |
| G | 7.36 | BSC | 0.290 | BSC |
| H | 2.54 | BSC | 0.100 | BSC |
| J | 0.43 | 0.55 | 0.017 | 0.022 |
| K | 2.36 | — | 0.290 | — |
| L | 19.06 | BSC | 0.750 | BSC |
| R | 11.98 | 12.19 | 0.472 | 0.480 |
| S | 3.24 | 3.37 | 0.124 | 0.133 |
| U | 3.07 | 3.27 | 0.115 | 0.129 |
| V | 4.36 | 4.52 | 0.172 | 0.178 |
| W | 2.38 | 2.69 | 0.094 | 0.106 |
| B1 | 0.89 | 1.14 | 0.035 | 0.045 |
| C1 | 2.54 | NOM | 0.100 | NOM |

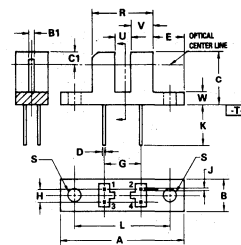

- NOTES:
- DIMENSIONS A AND B ARE DATUMS AND T IS A DATUM SURFACE.
 - POSITIONAL TOLERANCE FOR MOUNTING HOLES:
Ⓢ 0.13 (0.014) Ⓢ T | A Ⓢ B Ⓢ
 - POSITIONAL TOLERANCE FOR LEAD DIMENSION J:
Ⓢ 0.13 (0.009) Ⓢ T | B Ⓢ
 - POSITIONAL TOLERANCE FOR LEAD DIMENSION D:
Ⓢ 0.13 (0.009) Ⓢ T | A Ⓢ B Ⓢ
 - DIMENSIONING AND TOLERANCING PER Y14.5, 1973.

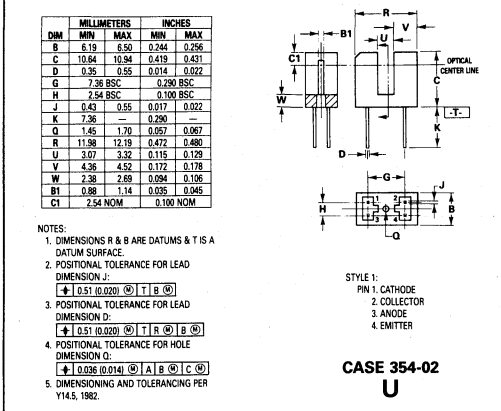

| DIM | MIN | MAX | MIN | MAX |
|-----|-------|-------|-------|-------|
| B | 6.18 | 6.32 | 0.243 | 0.249 |
| C | 12.98 | 12.82 | 0.495 | 0.505 |
| D | 0.36 | 0.56 | 0.014 | 0.022 |
| G | 10.16 | BSC | 0.400 | BSC |
| H | 2.54 | BSC | 0.100 | BSC |
| J | 0.43 | 0.55 | 0.017 | 0.022 |
| K | 7.27 | — | 0.290 | — |
| R | 13.69 | 13.94 | 0.539 | 0.549 |
| U | 4.83 | 5.08 | 0.190 | 0.200 |
| V | 8.77 | 9.01 | 0.345 | 0.355 |
| W | 0.95 | 1.00 | 0.100 | 0.100 |
| B1 | 0.87 | 0.99 | 0.034 | 0.039 |
| C1 | 4.32 | NOM | 0.170 | NOM |

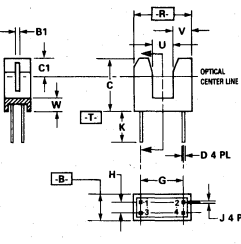

- NOTES:
- DIMENSIONING AND TOLERANCING PER ANSI Y14.5M, 1982.
 - POSITIONAL TOLERANCE FOR LEAD DIMENSION D:
Ⓢ 0.51 (0.020) Ⓢ T | R Ⓢ
 - POSITIONAL TOLERANCE FOR LEAD DIMENSION J:
Ⓢ 0.51 (0.020) Ⓢ T | B Ⓢ
 - CONTROLLING DIMENSION: INCH.

7

Slotted Optical Switches Transistor Output

These devices consist of two gallium arsenide infrared emitting diodes facing two NPN silicon phototransistors across a 0.100" wide slot in the housing. Switching takes place when an opaque object in the slot interrupts the infrared beam.

In addition to their use in position and motion indicators, dual channel interrupters enable the sensing of *direction* of motion.

- 0.020" Aperture Width
- Easy PCB Mounting
- Cost Effective
- Uses Long-Lived LPE IRED

MOC70W1
MOC70W2

**DUAL CHANNEL
 SLOTTED
 OPTICAL SWITCHES
 TRANSISTOR OUTPUT**

ABSOLUTE MAXIMUM RATINGS (25°C)

| Rating | Symbol | Value | Unit |
|---|------------------|------------|------|
| INPUT LED | | | |
| Power Dissipation | P _D | 150* | mW |
| Forward Current (Continuous) | I _F | 60 | mA |
| Reverse Voltage | V _R | 6 | V |
| OUTPUT TRANSISTOR | | | |
| Power Dissipation | P _D | 150* | mW |
| Collector-Emitter Voltage | V _{CEO} | 30 | V |
| TOTAL DEVICE | | | |
| Storage Temperature | T _{stg} | -40 to +85 | °C |
| Operating Temperature | T _J | -40 to +85 | °C |
| Lead Soldering Temperature (5 seconds maximum) | T _L | 260 | °C |

*Derate 2 mW/°C above 25°C ambient.

INDIVIDUAL ELECTRICAL CHARACTERISTICS (25°C) (See Note 1)

| Characteristic | Symbol | Min | Typ | Max | Unit |
|--|----------------------|-----|-----|-----|------|
| INPUT LED | | | | | |
| Reverse Breakdown Voltage (I _R = 100 μA) | V _{(BR)R} | 6 | — | — | V |
| Forward Voltage (I _F = 50 mA) | V _F | — | 1.3 | 1.8 | V |
| Reverse Current (V _R = 6 V, R _L = 1 MΩ) | I _R | — | 50 | — | nA |
| Capacitance (V = 0 V, f = 1 MHz) | C | — | 25 | — | pF |
| OUTPUT TRANSISTOR | | | | | |
| Breakdown Voltage (I _C = 10 mA, H ≈ 0) | V _{(BR)CEO} | 30 | — | — | V |
| Collector Dark Current (V _{CE} = 10 V, H ≈ 0, Note 1) | I _{CEO} | — | — | 100 | nA |

NOTE 1: Stray irradiation can alter values of characteristics. Adequate shielding should be provided.

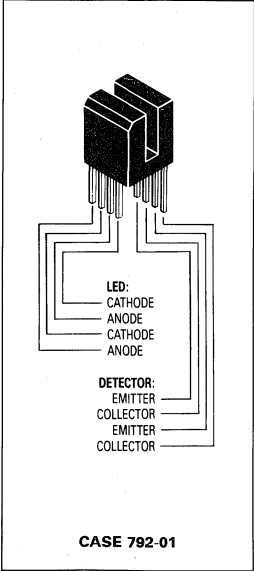

Slotted Optical Switches Darlington Output

Each device consists of a gallium arsenide infrared emitting diode facing a silicon NPN photodarlington in a molded plastic housing. A slot in the housing between the emitter and the detector provides the means for mechanically interrupting the infrared beam. These devices are widely used as position sensors in a variety of applications.

- Single Unit for Easy PCB Mounting
- Non-Contact Electrical Switching
- Long-Life Liquid Phase Epi Emitter
- Several Convenient Package Styles

MAXIMUM RATINGS

| Rating | Symbol | Value | Unit |
|--------|--------|-------|------|
|--------|--------|-------|------|

INPUT LED

| | | | |
|--|-------|----------|----------------------------|
| Reverse Voltage | V_R | 6 | Volts |
| Forward Current — Continuous | I_F | 60 | mA |
| Input LED Power Dissipation ($\alpha T_A = 25^\circ\text{C}$ Derate above 25°C) | P_D | 150 2 | mW mW/ $^\circ\text{C}$ |

OUTPUT DARLINGTON

| | | | |
|--|-----------|----------|----------------------------|
| Collector-Emitter Voltage | V_{CEO} | 30 | Volts |
| Output Current — Continuous | I_C | 100 | mA |
| Output Darlington Power Dissipation ($\alpha T_A = 25^\circ\text{C}$ Derate above 25°C) | P_D | 150 2 | mW mW/ $^\circ\text{C}$ |

TOTAL DEVICE

| | | | |
|--|-----------|-------------|----------------------------|
| Ambient Operating Temperature Range | T_A | -40 to +100 | $^\circ\text{C}$ |
| Storage Temperature | T_{stg} | -40 to +100 | $^\circ\text{C}$ |
| Lead Soldering Temperature (5 seconds max) | — | 260 | $^\circ\text{C}$ |
| Total Device Power Dissipation @ $T_A = 25^\circ\text{C}$ Derate above 25°C | P_D | 300 4 | mW mW/ $^\circ\text{C}$ |

MOC71 Series

SLOTTED OPTICAL SWITCHES DARLINGTON OUTPUT



CASE 374-01
H

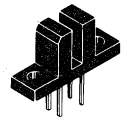

CASE 354A-01
T



CASE 354E-01
P



CASE 354-02
U



CASE 354G-01
V

SWITCHING TIMES

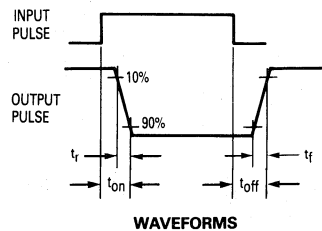
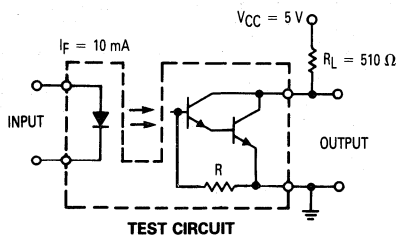

PART NUMBER DERIVATION

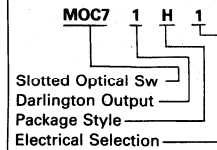

MOC71 Series

ELECTRICAL CHARACTERISTICS ($T_A = 25^\circ\text{C}$ unless otherwise noted. Note 1.)

| Characteristic | Symbol | Min | Typ | Max | Unit |
|---|--------|-----|------|-----|---------------|
| INPUT LED | | | | | |
| Forward Voltage ($I_F = 50\text{ mA}$) | V_F | 0.9 | 1.3 | 1.8 | Volts |
| Reverse Leakage ($V_R = 6\text{ V}$) | I_R | — | 0.05 | 100 | μA |
| Capacitance ($V = 0\text{ V}$, $f = 1\text{ MHz}$) | C_J | — | 18 | — | pF |

OUTPUT DARLINGTON

| | | | | | |
|--|---------------|----|--------|-----|-------|
| Dark Current ($V_{CE} = 10\text{ V}$) | I_{CEO} | — | 10 | 100 | nA |
| Collector-Emitter Breakdown Voltage ($I_C = 1\text{ mA}$) | $V_{(BR)CEO}$ | 30 | 90 | — | Volts |
| Capacitance ($V = 0\text{ V}$, $f = 1\text{ MHz}$) | C_{CE} | — | 5.5 | — | pF |
| DC Current Gain ($V_{CE} = 10\text{ V}$, $I_C = 2\text{ mA}$) | h_{FE} | — | 10,000 | — | — |

COUPLED (Note 2)

| | | | | | | |
|--|----------|---------------|-----|-----|---|---------------|
| Output Collector Current ($I_F = 5\text{ mA}$, $V_{CE} = 5\text{ V}$) | MOC71__1 | I_C | 2.5 | 5 | — | mA |
| | MOC71__3 | | 8 | 14 | — | |
| Output Collector Current ($I_F = 10\text{ mA}$, $V_{CE} = 5\text{ V}$) | MOC71__1 | I_C | 7.5 | 15 | — | mA |
| | MOC71__3 | | 20 | 35 | — | |
| Collector-Emitter Saturation Voltage ($I_C = 1.8\text{ mA}$, $I_F = 10\text{ mA}$) | | $V_{CE(sat)}$ | — | — | 1 | Volts |
| Turn-On Time ($I_F = 10\text{ mA}$, $V_{CC} = 5\text{ V}$, $R_L = 510\ \Omega$) | | t_{on} | — | 120 | — | μs |
| Turn-Off Time ($I_F = 10\text{ mA}$, $V_{CC} = 5\text{ V}$, $R_L = 510\ \Omega$) | | t_{off} | — | 500 | — | μs |

- Notes: 1. Stray radiation can alter values of characteristics. Adequate light shielding should be provided.
2. No actuator in sensing gap.

TYPICAL CHARACTERISTICS

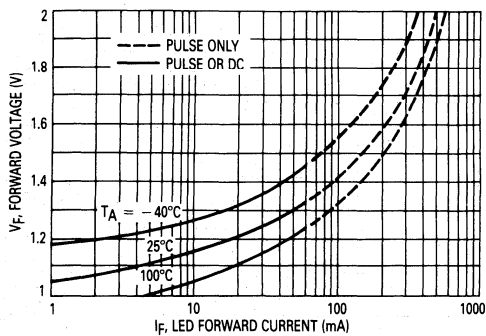

Figure 1. LED Forward Voltage versus Forward Current

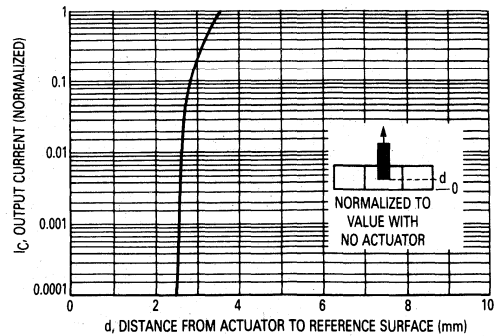

Figure 2. Output Current versus Actuator Position

MOC71 Series

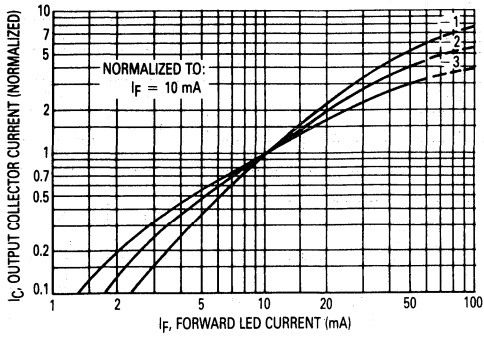

Figure 3. Output Current versus Input Current

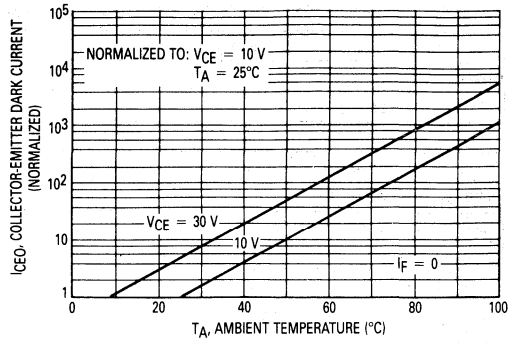

Figure 4. Collector-Emitter Dark Current versus Ambient Temperature

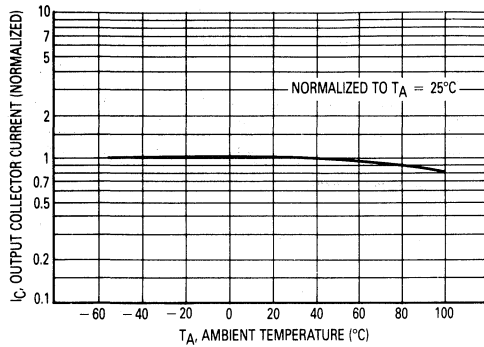

Figure 5. Output Current versus Ambient Temperature

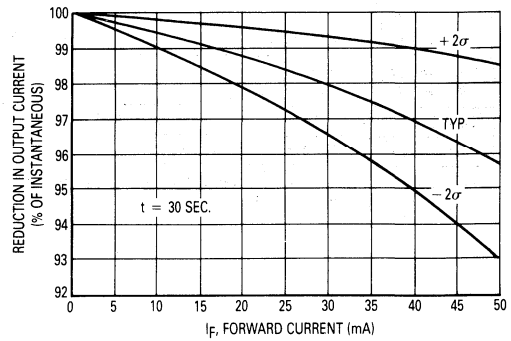

Figure 6. Reduction in Output Current Due to LED Heating versus Forward Current

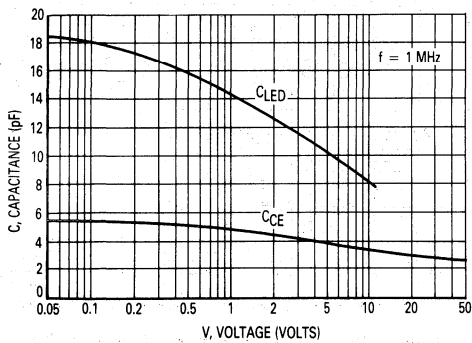

Figure 7. Capacitances versus Voltage

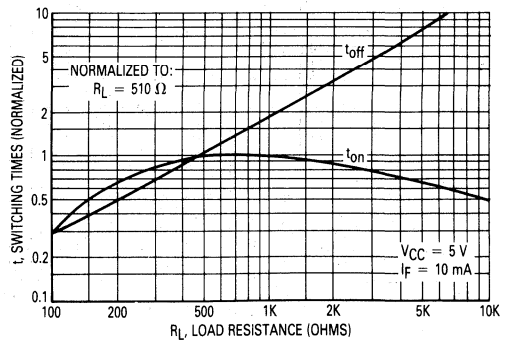
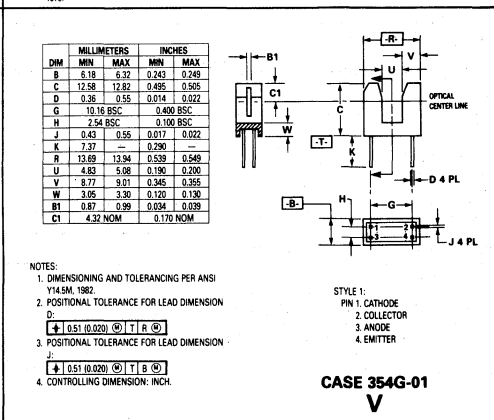
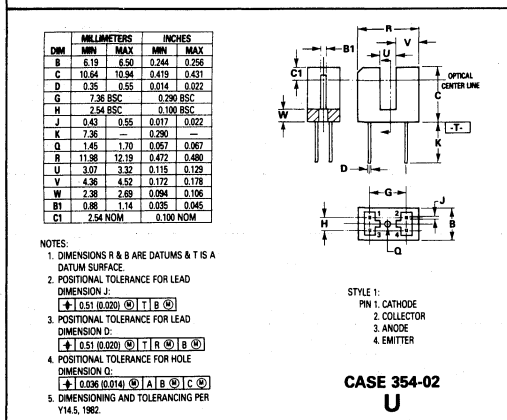
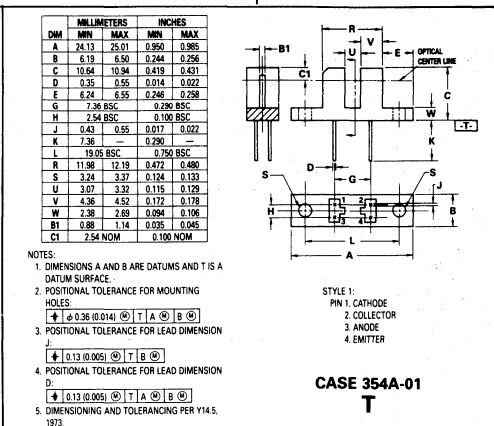
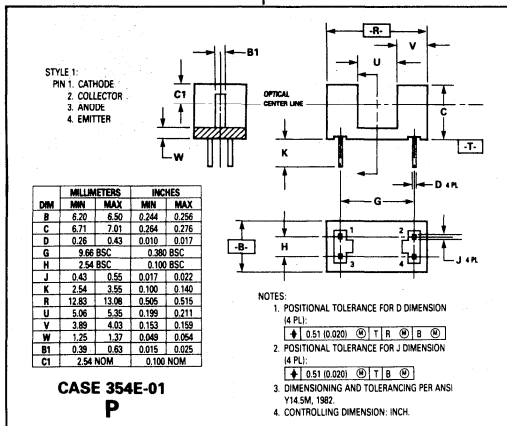
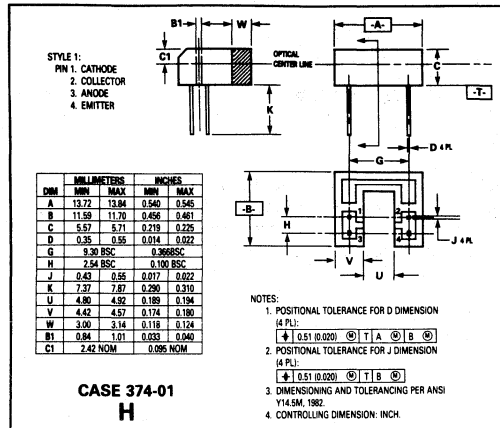

Figure 8. Switching Times versus Load Resistance



MOC71 Series

OUTLINE DIMENSIONS



Slotted Optical Switch Darlington Output

These devices consist of two gallium arsenide infrared emitting diodes facing two NPN silicon photodarlington across a 0.100" wide slot in the housing. Switching takes place when an opaque object in the slot interrupts the infrared beam.

Dual channel interrupters (switches) can sense *direction* of motion as well as position and speed.

- High Gain Darlington Output
- 0.020" Detector Aperture Width
- Easy PCB Mounting
- Cost Effective
- Uses Long-Lived LPE IRED

MOC71W1

**DUAL CHANNEL
SLOTTED
OPTICAL SWITCH
DARLINGTON OUTPUT**

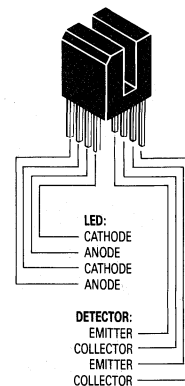

CASE 792-01

ABSOLUTE MAXIMUM RATINGS (25°C)

| Rating | Symbol | Value | Unit |
|---|------------------|------------|------|
| INPUT LED | | | |
| Power Dissipation | P _D | 150* | mW |
| Forward Current (Continuous) | I _F | 60 | mA |
| Reverse Voltage | V _R | 6 | V |
| OUTPUT DARLINGTON | | | |
| Power Dissipation | P _D | 150* | mW |
| Collector-Emitter Voltage | V _{CEO} | 30 | V |
| TOTAL DEVICE | | | |
| Storage Temperature | T _{stg} | -40 to +85 | °C |
| Operating Temperature | T _J | -40 to +85 | °C |
| Lead Soldering Temperature (5 seconds maximum) | T _L | 260 | °C |

*Derate 2 mW/°C above 25°C ambient.

INDIVIDUAL ELECTRICAL CHARACTERISTICS (25°C) (See Note 1)

| Characteristic | Symbol | Min | Typ | Max | Unit |
|---|----------------------|-----|-----|-----|------|
| INPUT LED | | | | | |
| Reverse Breakdown Voltage (I _R = 100 μA) | V _{(BR)R} | 6 | — | — | V |
| Forward Voltage (I _F = 60 mA) | V _F | — | — | 1.8 | V |
| Reverse Current (V _R = 6 V, R _L = 1 MΩ) | I _R | — | 50 | — | nA |
| Capacitance (V = 0 V, f = 1 MHz) | C | — | 25 | — | pF |
| OUTPUT DARLINGTON | | | | | |
| Breakdown Voltage (I _C = 1 mA, I _F = 0) | V _{(BR)CEO} | 30 | — | — | V |
| Collector Dark Current (V _{CE} = 10 V, I _F = 0) | I _{CEO} | — | — | 100 | nA |

NOTE 1: Stray irradiation can alter values of characteristics. Adequate shielding should be provided.

MOC71W1

COUPLED ELECTRICAL CHARACTERISTICS (25°C, See Note 1)

| Characteristics | Symbol | Min | Typ | Max | Unit |
|--|---------------|-----|-----|-----|---------------|
| $I_F = 5 \text{ mA}, V_{CE} = 5 \text{ V}$ | $I_{CE(ON)}$ | 2.5 | — | — | mA |
| $I_F = 10 \text{ mA}, V_{CE} = 5 \text{ V}$ | $I_{CE(ON)}$ | 7.5 | — | — | mA |
| $I_F = 10 \text{ mA}, I_C = 1.8 \text{ mA}$ | $V_{CE(sat)}$ | — | — | 1 | V |
| $I_F \text{ (opposite LED)} = 10 \text{ mA}, V_{CE} = 5 \text{ V}$ | I_{CX} | — | 20 | — | μA |

NOTE 1: Stray irradiation can alter values of characteristics. Adequate shielding should be provided.

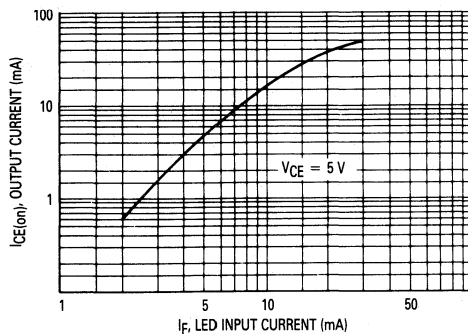

Figure 1. Typical Output Current versus Input Current

OUTLINE DIMENSIONS

NOTES:

- DIMENSIONING AND TOLERANCING PER ANSI Y14.5M, 1982.
- CONTROLLING DIMENSION: INCH.

| DIM | MILLIMETERS | | INCHES | |
|-----|-------------|-------|-----------|-------|
| | MIN | MAX | MIN | MAX |
| A | 11.31 | 11.60 | 0.445 | 0.457 |
| B | 11.77 | 12.11 | 0.463 | 0.477 |
| C | 9.35 | 9.70 | 0.368 | 0.382 |
| D | 0.36 | 0.55 | 0.014 | 0.022 |
| F | 0.49 | 0.53 | 0.019 | 0.021 |
| G | 7.62 BSC | | 0.300 BSC | |
| H | 2.54 BSC | | 0.100 BSC | |
| J | 0.44 | 0.55 | 0.017 | 0.022 |
| K | 7.37 | — | 0.290 | — |
| L | 5.38 BSC | | 0.212 BSC | |
| R | 2.37 | 2.71 | 0.093 | 0.107 |
| V | 2.54 BSC | | 0.100 BSC | |
| W | 2.37 | 2.71 | 0.093 | 0.107 |

STYLE 2:

- CATHODE
- ANODE
- CATHODE
- ANODE
- COLLECTOR
- EMITTER
- COLLECTOR
- EMITTER

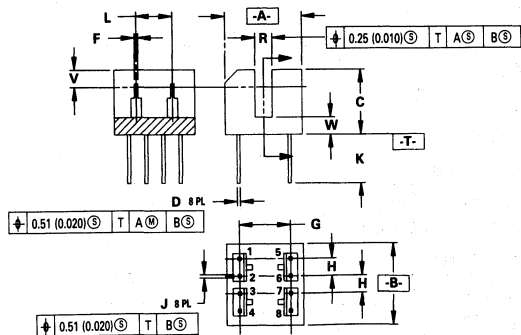

CASE 792-01

Slotted Optical Switches Logic Output

These devices consist of a GaAs LED facing a silicon, high-speed integrated circuit detector in a molded plastic housing. A slot in the housing between the emitter and the detector provides a means of mechanically interrupting the signal and switching the output from an on-state to an off-state. The detector incorporates a schmitt trigger which provides hysteresis for noise immunity and pulse shaping. The detector circuit is optimized for simplicity of operation and has an open-collector output for application flexibility.

MOC75T1,2
MOC75U1,2

**SLOTTED
 OPTICAL SWITCHES
 LOGIC OUTPUT**

ABSOLUTE MAXIMUM RATINGS: ($T_A = 25^\circ\text{C}$ unless otherwise noted)

| Rating | Symbol | Value | Unit |
|--------|--------|-------|------|
|--------|--------|-------|------|

INPUT LED

| | | | |
|--|-------|-----|----|
| Power Dissipation | P_D | 100 | mW |
| Forward Current (Continuous) | I_F | 60 | mA |
| Forward Current (Peak) (Pulse Width $\leq 1 \mu\text{s}$, PRR < 300 PPS) | I_F | 1.5 | A |
| Reverse Voltage | V_R | 6 | V |

OUTPUT DETECTOR

| | | | |
|----------------------|----------|------|----|
| Output Voltage Range | V_O | 0-16 | V |
| Supply Voltage Range | V_{CC} | 0-16 | V |
| Output Current | I_O | 50 | mA |
| Power Dissipation | P_D | 150* | mW |

TOTAL DEVICE

| | | | |
|--|-----------|------------|------------------|
| Storage Temperature | T_{stg} | -40 to +85 | $^\circ\text{C}$ |
| Operating Temperature | T_J | -40 to +85 | $^\circ\text{C}$ |
| Lead Soldering Temperature (5 seconds maximum) | T_L | 260 | $^\circ\text{C}$ |

*Derate 2 mW/ $^\circ\text{C}$ above 25 $^\circ\text{C}$ ambient.

T PACKAGE

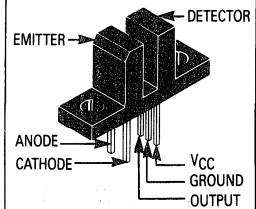

**CASE 354C-01
 PLASTIC**

U PACKAGE

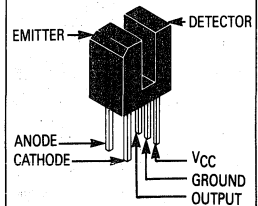

**CASE 354B-01
 PLASTIC**

MOC75T1, MOC75T2, MOC75U1, MOC75U2

INDIVIDUAL ELECTRICAL CHARACTERISTICS (0–70°C) (See Note 1)

| Characteristic | Symbol | Min | Typ | Max | Unit |
|---|-------------|-----|-----|-----|---------------|
| INPUT LED | | | | | |
| Forward Voltage ($I_F = 20 \text{ mA}$) | V_F | — | 1.1 | 1.6 | V |
| Reverse Current ($V_R = 3 \text{ V}$) | I_R | — | — | 10 | μA |
| Reverse Breakdown Voltage ($I_R = 100 \mu\text{A}$) | $V_{(BR)R}$ | 6 | — | — | V |
| Capacitance ($V = 0 \text{ V}$, $f = 1 \text{ MHz}$) | C | — | — | 100 | pF |

OUTPUT DETECTOR

| | | | | | |
|--|----------------------|---|-----|-----|---------------|
| Operating Voltage | V_{CC} | 3 | — | 15 | V |
| Supply Current ($I_F = 0$, $V_{CC} = 5 \text{ V}$) | $I_{CC(\text{off})}$ | — | 1.3 | 5 | mA |
| Output Current, High ($I_F = 0$, $V_{CC} = V_O = 15 \text{ V}$) | I_{OH} | — | — | 100 | μA |

COUPLED (0–70°C) (See Note 1)

| | | | | | | |
|--|--|--|------------|----------|----------|---------------|
| Threshold Current, ON ($R_L = 270 \Omega$, $V_{CC} = 5 \text{ V}$) | MOC75(T,U)1 MOC75(T,U)2 | $I_{F(\text{on})}$ | — — | 20 10 | 30 15 | mA |
| Threshold Current, OFF ($R_L = 270 \Omega$, $V_{CC} = 5 \text{ V}$) | MOC75(T,U)1 MOC75(T,U)2 | $I_{F(\text{off})}$ | 0.5 0.5 | 15 8 | — — | mA |
| Hysteresis Ratio ($R_L = 270 \Omega$, $V_{CC} = 5 \text{ V}$) | | $\frac{I_{F(\text{off})}}{I_{F(\text{on})}}$ | — | 0.75 | — | — |
| Supply Current ($I_F = I_{F(\text{on})}$, $V_{CC} = 5 \text{ V}$) | | $I_{CC(\text{on})}$ | — | 3 | 5 | mA |
| Output Voltage, Low ($I_F = I_{F(\text{on})}$, $V_{CC} = 5 \text{ V}$, $R_L = 270 \Omega$) | | V_{OL} | — | 0.2 | 0.4 | V |
| Turn-On Time | $R_L = 270 \Omega$, $V_{CC} = 5 \text{ V}$, $I_F = I_{F(\text{on})}$, $T_A = 25^\circ\text{C}$ | t_{on} | — | 1.2 | — | μs |
| Fall Time | | t_f | — | 0.1 | — | |
| Turn-Off Time | | t_{off} | — | 1.2 | — | |
| Rise Time | | t_r | — | 0.1 | — | |

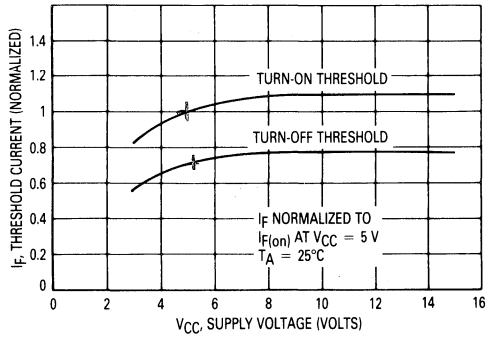

Figure 1. Normalized Threshold Current versus Supply Voltage

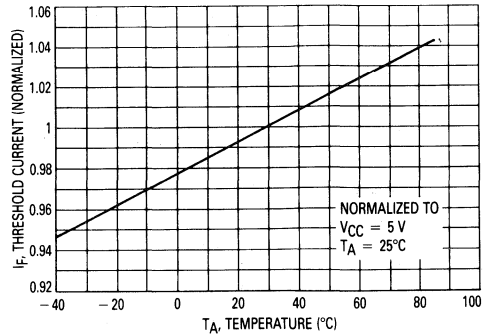

Figure 2. Threshold Current versus Temperature

MOC75T1, MOC75T2, MOC75U1, MOC75U2

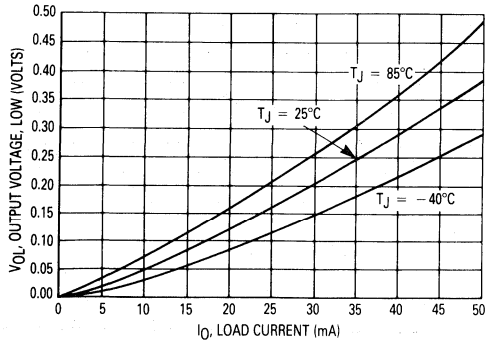

Figure 3. Output Voltage versus Load Current

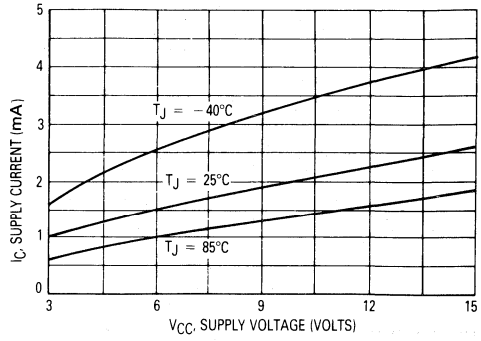

Figure 4. Supply Current versus Supply Voltage — Output High

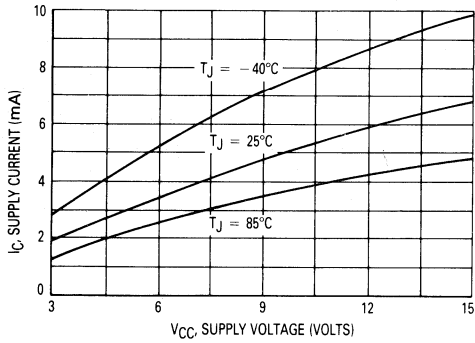

Figure 5. Supply Current versus Supply Voltage — Output Low

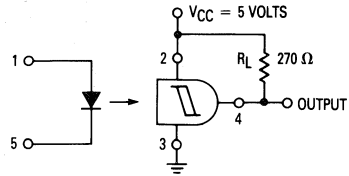

Figure 6. Test Circuit for Threshold Current Measurements

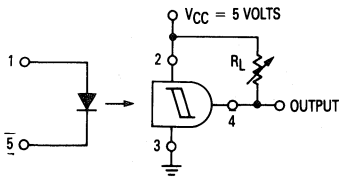

Figure 7. Test Circuit for Output Voltage versus Load Current Measurements

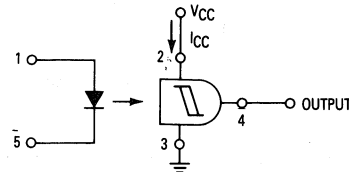

Figure 8. Test Circuit for Supply Current versus Supply Voltage Measurements

7

MOC75T1, MOC75T2, MOC75U1, MOC75U2

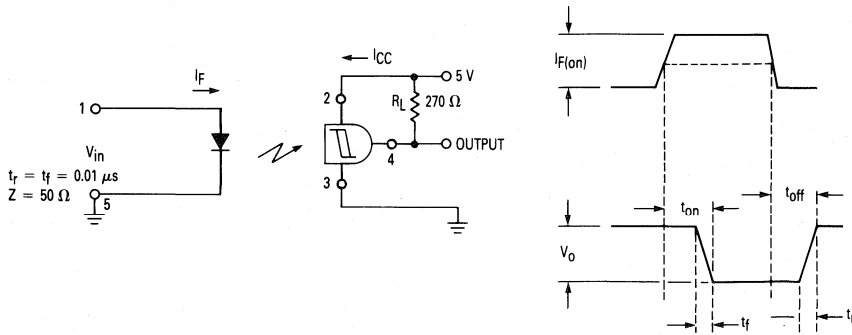
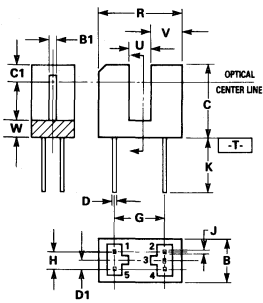

Figure 9. Switching Test Circuit

OUTLINE DIMENSIONS



U PACKAGE CASE 354B-01

| DIM | MILLIMETERS | | INCHES | |
|-----|-------------|-----------|--------|-------|
| | MIN | MAX | MIN | MAX |
| B | 6.19 | 6.50 | 0.244 | 0.256 |
| C | 10.64 | 10.94 | 0.419 | 0.431 |
| D | 0.35 | 0.55 | 0.014 | 0.022 |
| G | 7.36 BSC | 0.290 BSC | | |
| H | 2.54 BSC | 0.100 BSC | | |
| J | 0.43 | 0.55 | 0.017 | 0.022 |
| K | 7.36 | — | 0.290 | — |
| R | 11.98 | 12.19 | 0.472 | 0.480 |
| U | 3.07 | 3.32 | 0.115 | 0.129 |
| V | 4.36 | 4.52 | 0.172 | 0.178 |
| W | 2.38 | 2.69 | 0.094 | 0.106 |
| B1 | 0.68 | 1.14 | 0.035 | 0.045 |
| C1 | 2.54 NOM | 0.100 NOM | | |
| D1 | 1.27 BSC | 0.050 BSC | | |

STYLE 1:
PIN 1. CATHODE
2. VCC
3. GROUND
4. OUTPUT
5. ANODE

- NOTES:
- DIMENSIONS R AND B ARE DATUMS AND $\overline{\text{T}}$ IS A DATUM SURFACE.
 - POSITIONAL TOLERANCE FOR LEAD DIMENSION J:
 $\pm 0.51 (0.020) \text{ (M)} \text{ T } \text{B } \text{(M)}$
 - POSITIONAL TOLERANCE FOR LEAD DIMENSION D:
 $\pm 0.51 (0.020) \text{ (M)} \text{ T } \text{R } \text{(M)} \text{ B } \text{(M)}$
 - DIMENSIONING AND TOLERANCING ARE PER Y14.5, 1982.

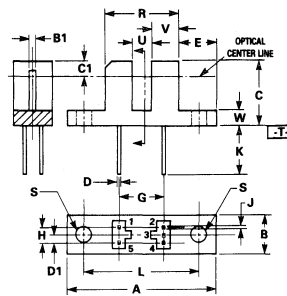

T PACKAGE CASE 354C-01

| DIM | MILLIMETERS | | INCHES | |
|-----|-------------|-----------|--------|-------|
| | MIN | MAX | MIN | MAX |
| A | 24.13 | 25.01 | 0.950 | 0.985 |
| B | 6.19 | 6.50 | 0.244 | 0.256 |
| C | 10.64 | 10.94 | 0.419 | 0.431 |
| D | 0.35 | 0.55 | 0.014 | 0.022 |
| E | 6.24 | 6.55 | 0.246 | 0.258 |
| G | 7.36 BSC | 0.290 BSC | | |
| H | 2.54 BSC | 0.100 BSC | | |
| J | 0.43 | 0.55 | 0.017 | 0.022 |
| K | 7.36 | — | 0.290 | — |
| L | 19.05 BSC | 0.750 BSC | | |
| R | 11.98 | 12.19 | 0.472 | 0.480 |
| S | 3.24 | 3.37 | 0.124 | 0.133 |
| U | 3.07 | 3.32 | 0.115 | 0.129 |
| V | 4.36 | 4.52 | 0.172 | 0.178 |
| W | 2.38 | 2.69 | 0.094 | 0.106 |
| B1 | 0.68 | 1.14 | 0.035 | 0.045 |
| C1 | 2.54 NOM | 0.100 NOM | | |
| D1 | 1.27 BSC | 0.050 BSC | | |

STYLE 1:
PIN 1. CATHODE
2. VCC
3. GROUND
4. OUTPUT
5. ANODE

- NOTES:
- DIMENSIONS A AND B ARE DATUMS AND $\overline{\text{T}}$ IS A DATUM SURFACE.
 - POSITIONAL TOLERANCE FOR MOUNTING HOLES:
 $\pm 0.36 (0.014) \text{ (M)} \text{ T } \text{A } \text{(M)} \text{ B } \text{(M)}$
 - POSITIONAL TOLERANCE FOR LEAD DIMENSION J:
 $\pm 0.51 (0.020) \text{ (M)} \text{ T } \text{B } \text{(M)}$
 - POSITIONAL TOLERANCE FOR LEAD DIMENSION D:
 $\pm 0.51 (0.020) \text{ (M)} \text{ T } \text{A } \text{(M)} \text{ B } \text{(M)}$
 - DIMENSIONING AND TOLERANCING PER Y14.5, 1982.



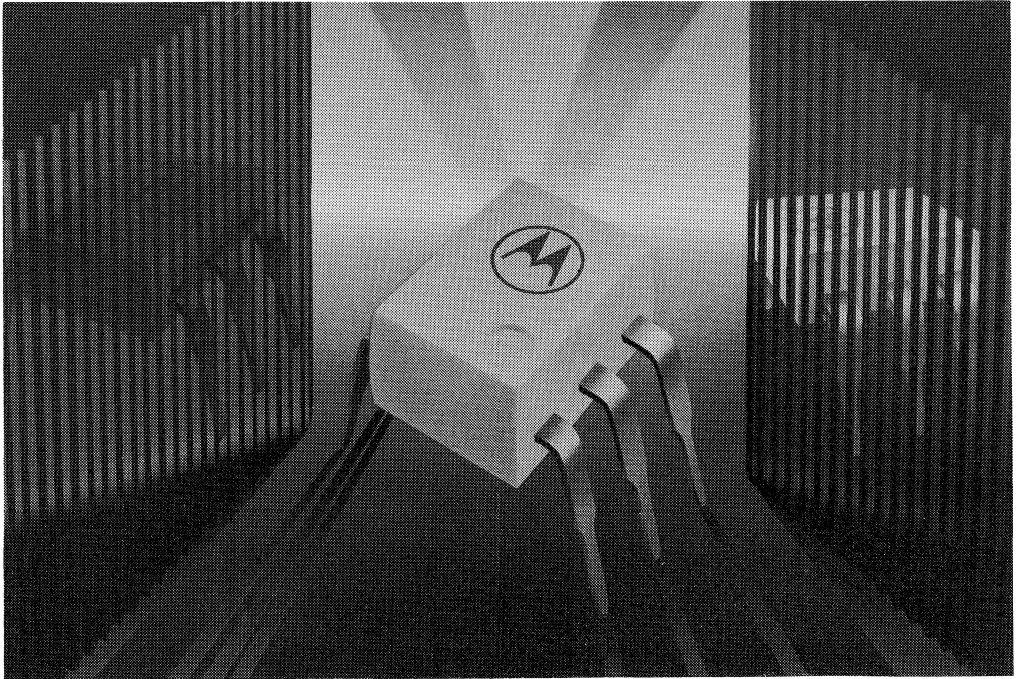

Chips Data Sheets

8

Photo Detector Chip

Diode Output

MFODC1100

... designed for infrared radiation detection in high frequency Fiber Optic Systems.

- Fast Response — 1 ns Max
- Anode/Cathode Metallization Compatible with Conventional Wire and Die Bonding Techniques
- Available in Chip or Wafer Form

**FIBER OPTICS
 PHOTO DETECTOR
 CHIP
 DIODE OUTPUT**

MAXIMUM RATINGS ($T_A = 25^\circ\text{C}$ unless otherwise noted)

| Rating | Symbol | Value | Unit |
|--------------------------------------|-----------|-------------|------------------|
| Reverse Voltage | V_R | 50 | Volts |
| Power Dissipation ⁽¹⁾ | P_D | 50 | mW |
| Operating Junction Temperature Range | T_J | -65 to +125 | $^\circ\text{C}$ |
| Storage Temperature Range | T_{stg} | -65 to +200 | $^\circ\text{C}$ |

STATIC ELECTRICAL CHARACTERISTICS ($T_A = 25^\circ\text{C}$ unless otherwise noted)

| Characteristic | Symbol | Min | Typ | Max | Unit |
|---|-------------|-----|-----|-----|-------|
| Dark Current ($V_R = 5\text{ V}$, $R_L = 1\text{ M}\Omega$, $H = 0$) | I_D | — | — | 1 | nA |
| Reverse Breakdown Voltage ($I_R = 10\ \mu\text{A}$) | $V_{(BR)R}$ | 50 | — | — | Volts |
| Forward Voltage ($I_F = 50\text{ mA}$) | V_F | — | 0.7 | 1 | Volts |
| Junction Capacitance ($V_R = 5\text{ V}$, $f = 1\text{ MHz}$) | C_j | — | — | 2 | pF |

OPTICAL CHARACTERISTICS ($T_A = 25^\circ\text{C}$ unless otherwise noted)

| | | | | | |
|--|------------|-----|-----|---|---------------------------|
| Radiation Responsivity ($V_R = 5\text{ V}$, $\lambda = 850\text{ nm}$, $P = 10\ \mu\text{W}$) | R | 0.3 | 0.4 | — | $\mu\text{A}/\mu\text{W}$ |
| Response Time ($V_R = 5\text{ V}$, $\lambda = 850\text{ nm}$) | t_r, t_f | — | 0.5 | 1 | ns |

DIE SPECIFICATIONS

| Die Size Mils | Die Thickness Mils | Bond Pad Size Mils | | Metallization | | Active Area Square Mils |
|------------------|-----------------------|--------------------|---------|----------------------|---------------------|----------------------------|
| | | Anode | Cathode | Front ⁽²⁾ | Back ⁽³⁾ | |
| 30 x 30 | 8-10 | 4 dia. | 30 x 30 | Al | Au | 154 |

NOTES: 1. Maximum power dissipation rating is determined with chip mounted on a header or lead frame using conventional Motorola Semiconductor assembly techniques.

2. Thickness — a minimum of 10,000 Å.

3. Thickness — a minimum of 15,000 Å.

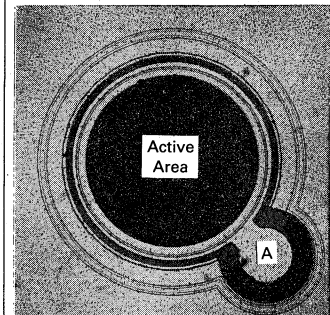

Back = Cathode

A = Anode

TYPICAL CHARACTERISTICS

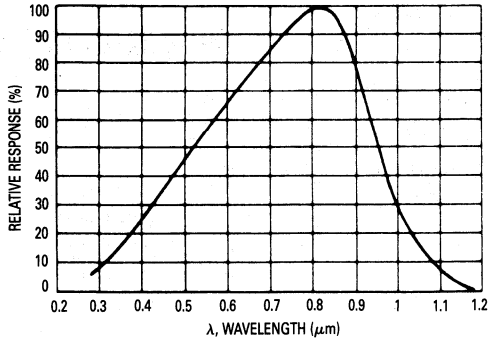

Figure 1. Relative Spectral Response

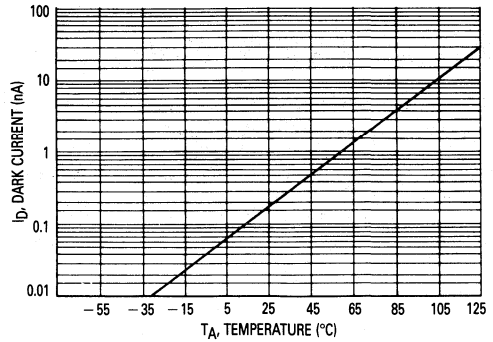

Figure 2. Dark Current versus Temperature

ORDERING INFORMATION

This die is available with the packaging and visual inspection options listed below. To obtain the desired combination of options, it will be necessary to add a suffix to

the die type number in accordance with the information given in Table 1.

TABLE 1

| Die Type Suffix | Packaging | Description | Visual Inspection |
|-----------------|------------|--|--|
| None | Multi-Pak | Chips in waffle package (individual chip compartments) | 100% visually inspected Rejects removed |
| WP | Wafer Pak | Wafer-probed, unscribed, unbroken and heat sealed in plastic bag (rejects are inked) | Visual inspected by sample to a LTPD = 10 |
| CP | Circle Pak | Wafer-probed, mounted on sticky film, sawed through and heat sealed in plastic bag (rejects are inked) | Visual inspected by sample to a LTPD = 10 |

Infrared LED Chip

... designed for fiber optic applications requiring fast response time.

- Fast Response — 90 MHz Bandwidth Typ
- High Power Output — 1.5 mW Min
- Anode/Cathode Metallization Compatible with Conventional Wire and Die Bonding Techniques
- Available in Chip or Wafer Form

MFOEC1200

**FIBER OPTICS
 INFRARED
 LED CHIP**

MAXIMUM RATINGS ($T_A = 25^\circ\text{C}$ unless otherwise noted)

| Rating | Symbol | Value | Unit |
|---|-----------|-------------|------------------|
| Reverse Voltage | V_R | 2 | Volts |
| Forward Current — Continuous | I_F | 100 | mA |
| Forward Current — Peak (1 μs Pulse, 50% Duty Cycle) | I_F | 200 | mA |
| Power Dissipation ⁽¹⁾ | P_D | 200 | mW |
| Operating Junction Temperature Range | T_J | -65 to +125 | $^\circ\text{C}$ |
| Storage Temperature Range | T_{stg} | -65 to +150 | $^\circ\text{C}$ |

STATIC ELECTRICAL CHARACTERISTICS ($T_A = 25^\circ\text{C}$ unless otherwise noted)

| Characteristic | Symbol | Min | Typ | Max | Unit |
|--|-------------|-----|-----|-----|-------|
| Reverse Breakdown Voltage ($I_R = 100 \mu\text{A}$) | $V_{(BR)R}$ | 2 | — | — | Volts |
| Forward Voltage ($I_F = 100 \text{mA}$) | V_F | 1 | — | 2.5 | Volts |
| Junction Capacitance ($V_R = 0 \text{V}$, $f = 1 \text{MHz}$) | C_j | — | 70 | — | pF |

OPTICAL CHARACTERISTICS ($T_A = 25^\circ\text{C}$ unless otherwise noted)

| Characteristic | Symbol | Min | Typ | Max | Unit |
|---|-------------|-----|-----|-----|------|
| Total Power Output ($I_F = 100 \text{mA}$) | P_O | 1.5 | — | — | mW |
| Wavelength of Peak Emission ($I_F = 100 \text{mA}$) | λ_p | — | 850 | — | nm |
| Optical Rise Time ($I_F = 100 \text{mA}$, 10%–90%) | t_r | — | 4 | 5 | ns |
| Optical Fall Time ($I_F = 100 \text{mA}$, 10%–90%) | t_f | — | 5 | 7 | ns |

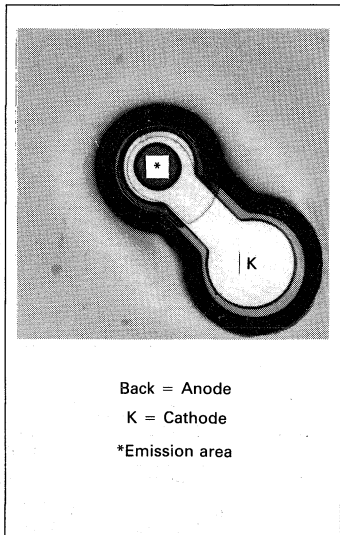

Back = Anode
 K = Cathode
 *Emission area

DIE SPECIFICATIONS

| Die Size Mils | Die Thickness Mils | Bond Pad Size Mils | | Metallization | | Active Area Square Mils |
|------------------|-----------------------|--------------------|----------|----------------------|---------------------|----------------------------|
| | | Anode | Cathode | Front ⁽²⁾ | Back ⁽³⁾ | |
| 24 x 24 | 8–10 | 24 x 24 | 3.5 dia. | Au | Au | 7 |

NOTES: 1. Maximum power dissipation rating is determined with chip mounted on a header or lead frame using conventional Motorola Semiconductor assembly techniques.

2. Thickness — a minimum of 10,000 Å.

3. Thickness — a minimum of 15,000 Å.

MFOEC1200

TYPICAL CHARACTERISTICS

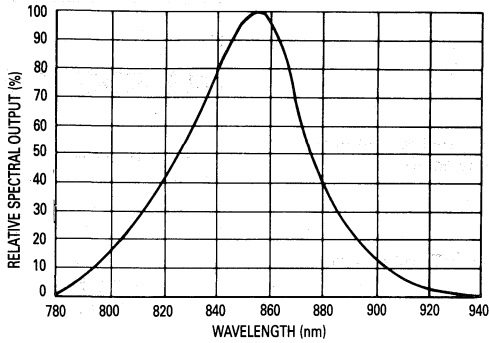

Figure 1. Spectral Output versus Wavelength

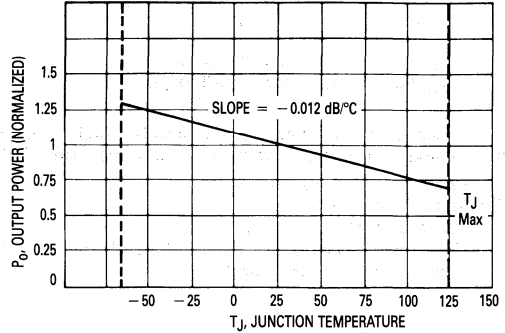

Figure 2. Power Output versus Junction Temperature

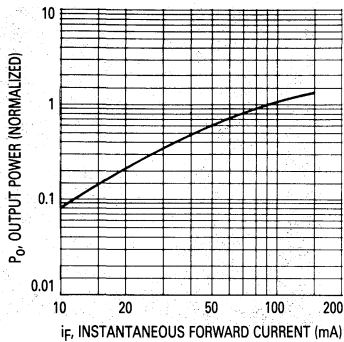

Figure 3. Normalized Output Power versus Forward Current

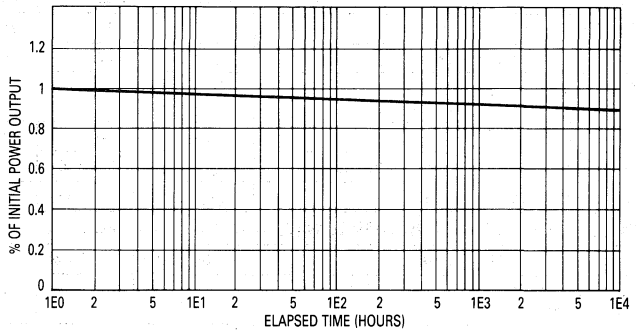

Figure 4. Power Output versus Time

ORDERING INFORMATION

This die is available with the packaging and visual inspection options listed below. To obtain the desired combination of options, it will be necessary to add a suffix to

the die type number in accordance with the information given in Table 1.

TABLE 1

| Die Type Suffix | Packaging | Description | Visual Inspection |
|-----------------|------------|--|--|
| None | Multi-Pak | Chips in waffle package (individual chip compartments) | 100% visually inspected Rejects removed |
| WP | Wafer Pak | Wafer-probed, unscribed, unbroken and heat sealed in plastic bag (rejects are inked) | Visual inspected by sample to a LTPD = 10 |
| CP | Circle Pak | Wafer-probed, mounted on sticky film, sawed through and heat sealed in plastic bag (rejects are inked) | Visual inspected by sample to a LTPD = 10 |

Infrared LED Chip

... designed for applications requiring a stable, high power, low drive current infrared emitting diode which is spectrally matched for use with silicon detectors.

- High Power Output — 2 mW Min
- Infrared Emission — 940 nm Typ
- Low Drive Current — 50 mA Typ
- Metallization Compatible with Conventional Wire and Die Bonding Techniques
- Available in Chip or Wafer Form

MLEDC1000

**GaAs
 INFRARED
 LED CHIP**

MAXIMUM RATINGS (T_A = 25°C unless otherwise noted)

| Rating | Symbol | Value | Unit |
|--|------------------|-------------|-------|
| Reverse Voltage | V _R | 3 | Volts |
| Forward Current, Continuous | I _F | 100 | mA |
| Forward Current, Peak (1 μs Pulse, 1% Duty Cycle) | I _F | 1 | A |
| Power Dissipation ⁽¹⁾ | P _D | 150 | mW |
| Operating Junction Temperature Range | T _J | -65 to +125 | °C |
| Storage Temperature Range | T _{stg} | -65 to +150 | °C |

STATIC ELECTRICAL CHARACTERISTICS (T_A = 25°C unless otherwise noted)

| Characteristic | Symbol | Min | Typ | Max | Unit |
|---|--------------------|-----|-----|-----|-------|
| Reverse Breakdown Voltage (I _R = 100 μA) | V _{(BR)R} | 3 | — | — | Volts |
| Forward Voltage (I _F = 50 mA) | V _F | — | — | 1.5 | Volts |
| Junction Capacitance (V _R = 0 V, f = 1 MHz) | C _j | — | 150 | — | pF |

OPTICAL CHARACTERISTICS (T_A = 25°C unless otherwise noted)

| | | | | | |
|---|----------------|---|-----|---|----|
| Total Power Output (I _F = 50 mA) | P _O | 2 | — | — | mW |
| Peak Emission Wavelength (I _F = 50 mA) | λ _p | — | 940 | — | nm |
| Optical Rise Time (I _F = 10 mA, 10% to 90%) | t _r | — | 600 | — | μs |
| Optical Fall Time (I _F = 10 mA, 10% to 90%) | t _f | — | 600 | — | μs |

DIE SPECIFICATIONS

| Die Size Mils | Die Thickness Mils | Bond Pad Size Mils | | Metallization | | Active Area Square Mils |
|------------------|-----------------------|--------------------|---------|----------------------|---------------------|----------------------------|
| | | Anode | Cathode | Front ⁽²⁾ | Back ⁽³⁾ | |
| 16 x 16 | 8-10 | 4 x 4 | 16 x 16 | Al | Au | 240 |

NOTES: 1. Maximum power dissipation rating is determined with chip mounted on a header or lead frame using conventional Motorola Semiconductor assembly techniques.

2. Thickness — a minimum of 10,000 Å.

3. Thickness — a minimum of 15,000 Å.

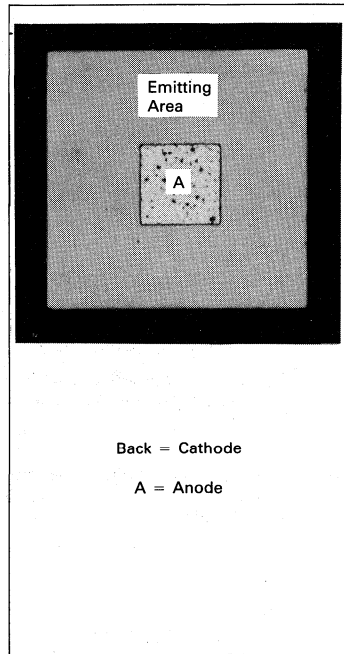

MLEDC1000

TYPICAL CHARACTERISTICS

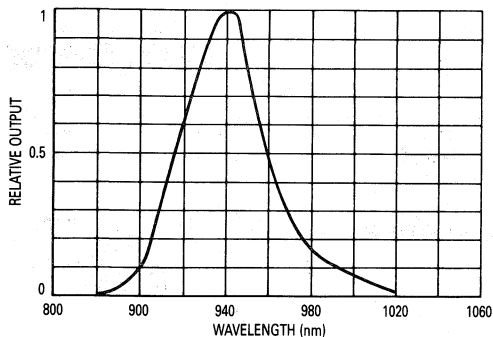

Figure 1. Relative Spectral Output

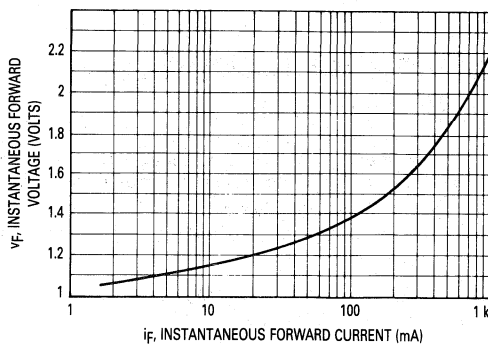

Figure 2. Forward Characteristics

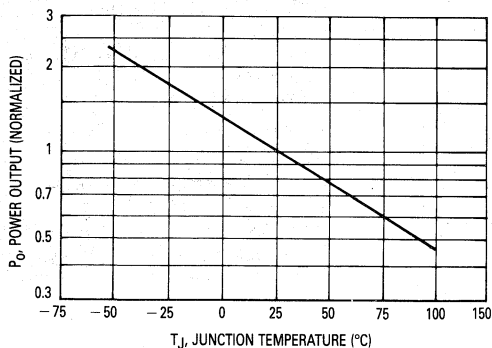

Figure 3. Power Output versus Junction Temperature

ORDERING INFORMATION

This die is available with the packaging and visual inspection options listed below. To obtain the desired combination of options, it will be necessary to add a suffix to the die type number in accordance with the information given in Table 1.

TABLE 1

| Die Type Suffix | Packaging | Description | Visual Inspection |
|-----------------|------------|--|--|
| None | Multi-Pak | Chips in waffle package (individual chip compartments) | 100% visually inspected Rejects removed |
| WP | Wafer Pak | Wafer-probed, unscribed, unbroken and heat sealed in plastic bag (rejects are inked) | Visual inspected by sample to a LTPD = 10 |
| CP | Circle Pak | Wafer-probed, mounted on sticky film, sawed through and heat sealed in plastic bag (rejects are inked) | Visual inspected by sample to a LTPD = 10 |

Photo Detector Chip

Diode Output

MRDC100

**PHOTO DETECTOR
 CHIP
 PIN SILICON
 DIODE OUTPUT**

... designed for the detection and demodulation of near infrared and visible light sources where ultrahigh speed and stable characteristics are required.

- Silicon Nitride Passivated Junction
- Anode/Cathode Metallization Compatible with Conventional Wire and Die Bonding Techniques
- Ultra Fast Response — 1 ns Typ
- High Responsivity — 0.4 $\mu\text{A}/\mu\text{W}$ Typ
- Available in Chip or Wafer Form

MAXIMUM RATINGS ($T_A = 25^\circ\text{C}$ unless otherwise noted)

| Rating | Symbol | Value | Unit |
|--|----------------|-------------|------------------|
| Reverse Voltage | V_R | 100 | Volts |
| Power Dissipation ⁽¹⁾ | P_D | 100 | mW |
| Operating Junction and Storage Temperature | T_J, T_{stg} | -65 to +200 | $^\circ\text{C}$ |

STATIC ELECTRICAL CHARACTERISTICS ($T_A = 25^\circ\text{C}$ unless otherwise noted)

| Characteristic | Symbol | Min | Typ | Max | Unit |
|---|-------------|-----|-----|-----|-------|
| Dark Current ($V_R = 20\text{ V}, H = 0$) | I_D | — | — | 10 | nA |
| Reverse Breakdown Voltage ($I_R = 10\ \mu\text{A}$) | $V_{(BR)R}$ | 100 | — | — | Volts |
| Forward Voltage ($I_F = 50\text{ mA}$) | V_F | — | — | 1.5 | Volts |
| Junction Capacitance ($V_R = 20\text{ V}, f = 1\text{ MHz}$) | C_j | — | 2.5 | 4 | pF |

OPTICAL CHARACTERISTICS ($T_A = 25^\circ\text{C}$ unless otherwise noted)

| | | | | | |
|--|-------------------|-----|-----|---|---------------------------|
| Responsivity ($V_R = 20\text{ V}, \lambda = 850\text{ nm}$) | R | 0.3 | 0.4 | — | $\mu\text{A}/\mu\text{W}$ |
| Switching Times ($V_R = 20\text{ V}, R_L = 50\ \Omega, \lambda = 850\text{ nm}, H = 1\text{ mW}/\text{cm}^2$) | t_{on}, t_{off} | — | 1 | — | ns |

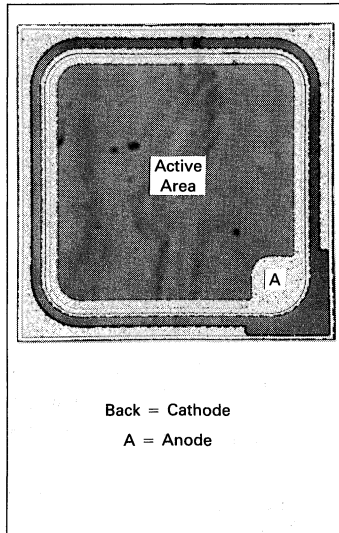

DIE SPECIFICATIONS

| Die Size Mils | Die Thickness Mils | Bond Pad Size Mils | | Metallization | | Active Area Square Mils |
|------------------|-----------------------|--------------------|---------|----------------------|---------------------|----------------------------|
| | | Anode | Cathode | Front ⁽²⁾ | Back ⁽³⁾ | |
| 30 x 30 | 8-10 | 4.5 x 4.5 | 30 x 30 | Al | Au | 380 |

NOTES: 1. Maximum power dissipation rating is determined with chip mounted on a header or lead frame using conventional Motorola Semiconductor assembly techniques.

2. Thickness — a minimum of 10,000 Å.

3. Thickness — a minimum of 15,000 Å.



MRDC100

TYPICAL CHARACTERISTICS

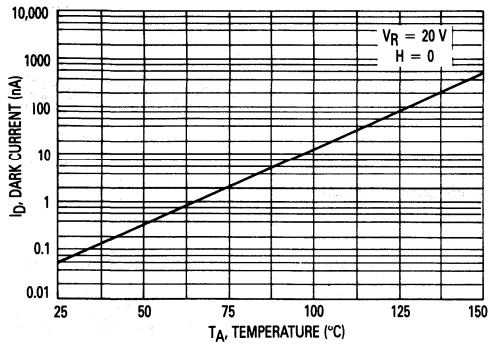

Figure 1. Dark Current versus Temperature

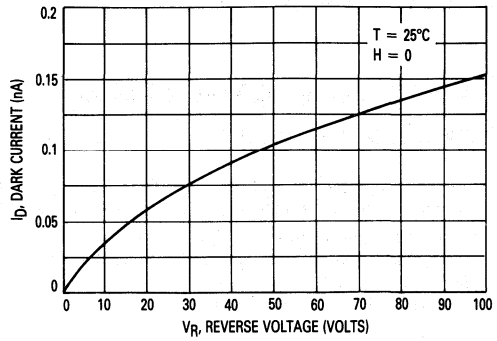

Figure 2. Dark Current versus Reverse Voltage

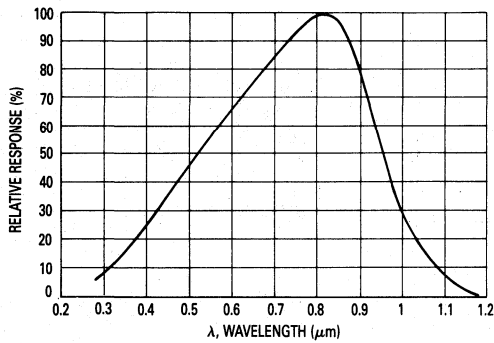

Figure 3. Relative Spectral Response

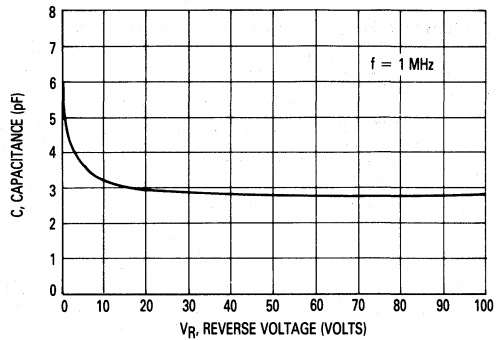

Figure 4. Capacitance versus Voltage

ORDERING INFORMATION

This die is available with the packaging and visual inspection options listed below. To obtain the desired combination of options, it will be necessary to add a suffix

to the die type number in accordance with the information given in Table 1.

TABLE 1

| Die Type Suffix | Packaging | Description | Visual Inspection |
|-----------------|------------|--|--|
| None | Multi-Pak | Chips in waffle package (individual chip compartments) | 100% visually inspected Rejects removed |
| WP | Wafer Pak | Wafer-probed, unscribed, unbroken and heat sealed in plastic bag (rejects are inked) | Visual inspected by sample to a LTPD = 10 |
| CP | Circle Pak | Wafer-probed, mounted on sticky film, sawed through and heat sealed in plastic bag (rejects are inked) | Visual inspected by sample to a LTPD = 10 |

Photo Detector Chip

Transistor Output

MRDC200

**PHOTO DETECTOR
 CHIP
 NPN SILICON
 TRANSISTOR OUTPUT**

... designed for detection and demodulation of near infrared and visible light sources where high sensitivity and stable characteristics are required.

- Silicon Nitride Passivation
- Emitter, Base, Collector Metallization Compatible with Conventional Wire and Die Bonding Techniques
- Available in Chip or Wafer Form

MAXIMUM RATINGS ($T_A = 25^\circ\text{C}$ unless otherwise noted)

| Rating | Symbol | Value | Unit |
|--------------------------------------|-----------|-------------|------------------|
| Collector-Emitter Voltage | V_{CEO} | 40 | Volts |
| Emitter-Collector Voltage | V_{ECO} | 7 | Volts |
| Collector-Base Voltage | V_{CBO} | 70 | Volts |
| Power Dissipation ⁽¹⁾ | P_D | 100 | mW |
| Operating Junction Temperature Range | T_J | -65 to +150 | $^\circ\text{C}$ |
| Storage Temperature Range | T_{stg} | -65 to +200 | $^\circ\text{C}$ |

STATIC ELECTRICAL CHARACTERISTICS ($T_A = 25^\circ\text{C}$ unless otherwise noted)

| Characteristic | Symbol | Min | Typ | Max | Unit |
|---|---------------|-----|-----|-----|-------|
| Collector Dark Current ($V_{CE} = 10\text{ V}, H \approx 0$) | I_{CEO} | — | — | 100 | nA |
| Collector-Base Breakdown Voltage ($I_{CB} = 100\ \mu\text{A}$) | $V_{(BR)CBO}$ | 70 | — | — | Volts |
| Collector-Emitter Breakdown Voltage ($I_{CE} = 100\ \mu\text{A}$) | $V_{(BR)CEO}$ | 40 | — | — | Volts |
| Emitter-Collector Breakdown Voltage ($I_{EC} = 100\ \mu\text{A}$) | $V_{(BR)ECO}$ | 7 | — | — | Volts |

OPTICAL CHARACTERISTICS ($T_A = 25^\circ\text{C}$ unless otherwise noted)

| | | | | | |
|---|-----------|----------------------|---|-----|---------------|
| Light Current ($V_C = 5\text{ V}, R_L = 100\ \text{Ohms}$) ⁽²⁾ | I_L | 0.8 | — | 22 | mA |
| Optical Turn-on Time ($I_L = 1\text{ mA}, \lambda = 940\text{ nm}, V_{CE} = 10\text{ V}$) | t_{on} | $R_L = 100\ \Omega$ | — | 9 | μs |
| | | $R_L = 1000\ \Omega$ | — | 11 | |
| | | $R_L = 1000\ \Omega$ | — | — | |
| Optical Turn-off Time ($I_L = 1\text{ mA}, \lambda = 940\text{ nm}, V_{CE} = 10\text{ V}$) | t_{off} | $R_L = 100\ \Omega$ | — | 8.5 | μs |
| | | $R_L = 1000\ \Omega$ | — | 13 | |
| | | $R_L = 1000\ \Omega$ | — | — | |

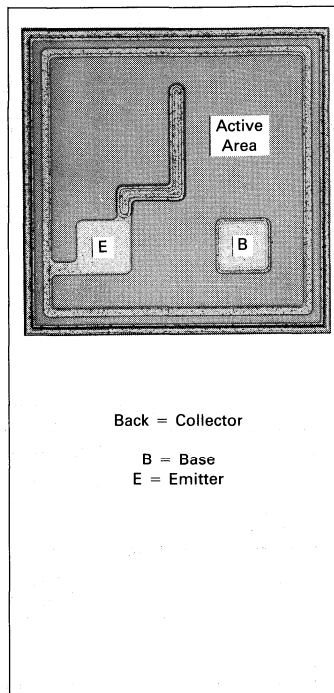

DIE SPECIFICATIONS

| Die Size Mils | Die Thickness Mils | Bond Pad Size Mils | | Metallization | | Active Area Square Mils |
|------------------|-----------------------|--------------------|-----------|----------------------|---------------------|----------------------------|
| | | Emitter | Base | Front ⁽³⁾ | Back ⁽⁴⁾ | |
| 25 x 25 | 8-10 | 3.5 x 3.5 | 3.5 x 3.5 | Al | Au | 270 |

- NOTES: 1. Maximum power dissipation rating is determined with chip mounted on a header or lead frame using conventional Motorola Semiconductor assembly techniques.
 2. Radiation flux density (H) equal to 5 mW/cm² emitted from a tungsten source at a color temperature of 2870K.
 3. Thickness — a minimum of 10,000 Å.
 4. Thickness — a minimum of 15,000 Å.

MRDC200

TYPICAL CHARACTERISTICS

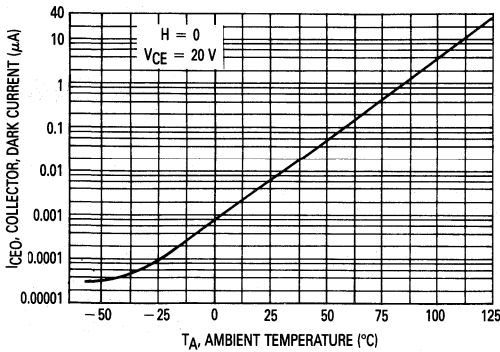

Figure 1. Dark Current versus Temperature

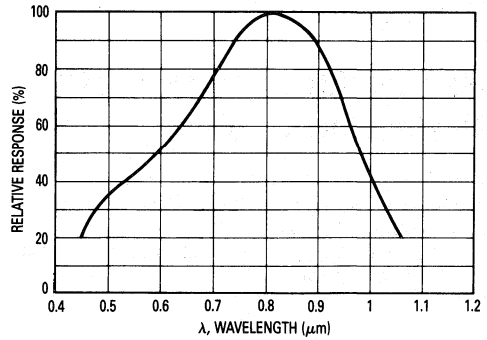

Figure 2. Constant Energy Spectral Response

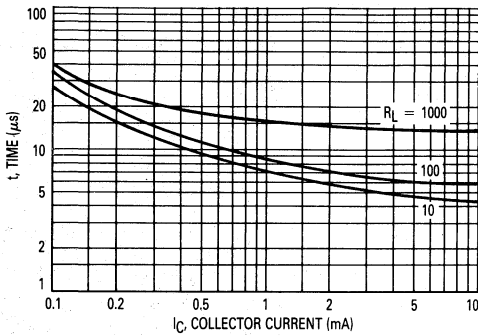

Figure 3. Typical Turn-On Switching Times

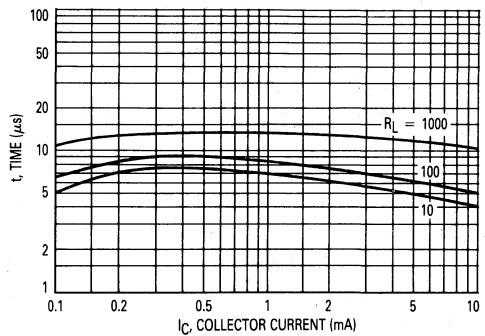

Figure 4. Typical Turn-Off Switching Times

ORDERING INFORMATION

This die is available with the packaging and visual inspection options listed below. To obtain the desired combination of options, it will be necessary to add a suffix to

the die type number in accordance with the information given in Table 1.

TABLE 1

| Die Type Suffix | Packaging | Description | Visual Inspection |
|-----------------|------------|--|--|
| None | Multi-Pak | Chips in waffle package (individual chip compartments) | 100% visually inspected Rejects removed |
| WP | Wafer Pak | Wafer-probed, unscrubbed, unbroken and heat sealed in plastic bag (rejects are inked) | Visual inspected by sample to a LTPD = 10 |
| CP | Circle Pak | Wafer-probed, mounted on sticky film, sawed through and heat sealed in plastic bag (rejects are inked) | Visual inspected by sample to a LTPD = 10 |

Photo Detector Chip

Darlington Output

MRDC400

**PHOTO DETECTOR
 CHIP
 NPN SILICON
 DARLINGTON OUTPUT**

... designed for the detection and demodulation of near infrared and visible light sources where ultrahigh sensitivity and stable characteristics are required.

- Silicon-Nitride Passivation
- Emitter, Base, Collector Metallization Compatible with Conventional Wire and Die Bonding Techniques
- Available in Chip or Wafer Form

MAXIMUM RATINGS ($T_A = 25^\circ\text{C}$ unless otherwise noted)

| Rating | Symbol | Value | Unit |
|--------------------------------------|-----------|-------------|------------------|
| Collector-Emitter Voltage | V_{CEO} | 50 | Volts |
| Emitter-Base Voltage | V_{EBO} | 6 | Volts |
| Collector-Base Voltage | V_{CBO} | 60 | Volts |
| Power Dissipation ⁽¹⁾ | P_D | 250 | mW |
| Operating Junction Temperature Range | T_J | -65 to +150 | $^\circ\text{C}$ |
| Storage Temperature Range | T_{stg} | -65 to +200 | $^\circ\text{C}$ |

STATIC ELECTRICAL CHARACTERISTICS ($T_A = 25^\circ\text{C}$ unless otherwise noted)

| Characteristic | Symbol | Min | Typ | Max | Unit |
|--|---------------|-----|-----|-----|---------------|
| Collector Dark Current ($V_{CE} = 10\text{ V}, H \approx 0$) | I_{CEO} | — | — | 100 | nA |
| Collector-Base Breakdown Voltage ($I_C = 100\ \mu\text{A}$) | $V_{(BR)CBO}$ | 55 | — | — | Volts |
| Collector-Emitter Breakdown Voltage ($I_C = 1\text{ mA}$) | $V_{(BR)CEO}$ | 45 | — | — | Volts |
| Emitter Base Leakage Current ($V_{EB} = 10\text{ V}$) | I_{EBO} | — | — | 100 | μA |

OPTICAL CHARACTERISTICS ($T_A = 25^\circ\text{C}$ unless otherwise noted)

| | | | | | |
|--|-----------|----------------------|---|-----|---------------|
| Light Current ($V_{CE} = 5\text{ V}, R_L = 10\text{ Ohms}$) ⁽²⁾ | I_L | 0.8 | — | 20 | mA |
| Optical Turn-On Time ($V_{CE} = 10\text{ V}, I_C = 20\text{ mA}, \lambda = 940\text{ nm}$) | t_{on} | $R_L = 100\ \Omega$ | — | 30 | μs |
| | | $R_L = 1000\ \Omega$ | — | 140 | |
| Optical Turn-Off Time ($V_{CE} = 10\text{ V}, I_C = 20\text{ mA}, \lambda = 940\text{ nm}$) | t_{off} | $R_L = 100\ \Omega$ | — | 35 | μs |
| | | $R_L = 1000\ \Omega$ | — | 210 | |

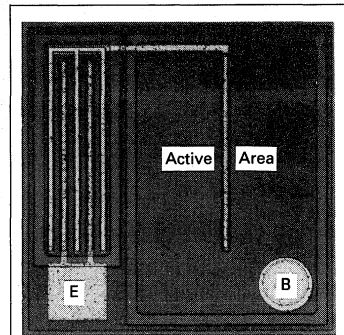

Back = Collector

B = Base
 E = Emitter

DIE SPECIFICATIONS

| Die Size Mils | Die Thickness Mils | Bond Pad Size Mils | | Metallization | | Active Area Square Mils |
|------------------|-----------------------|--------------------|--------|----------------------|---------------------|----------------------------|
| | | Emitter | Base | Front ⁽³⁾ | Back ⁽⁴⁾ | |
| 27 x 27 | 8-10 | 4 x 4 | 4 dia. | Al | Au | 357 |

- NOTES: 1. Maximum power dissipation rating is determined with chip mounted on a header or lead frame using conventional Motorola Semiconductor assembly techniques.
 2. Radiation flux density (H) equal to 1 mW/cm² emitted from a tungsten source at a color temperature of 2870K.
 3. Thickness — a minimum of 10,000 Å.
 4. Thickness — a minimum of 15,000 Å.

MRDC400

TYPICAL CHARACTERISTICS

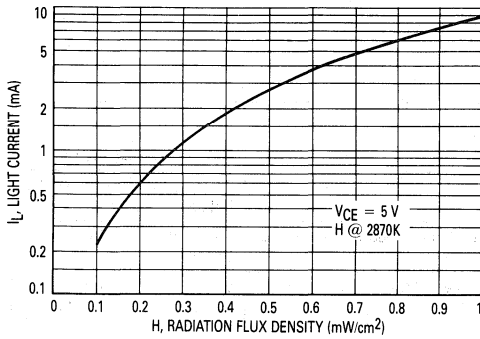

Figure 1. Light Current versus Irradiance

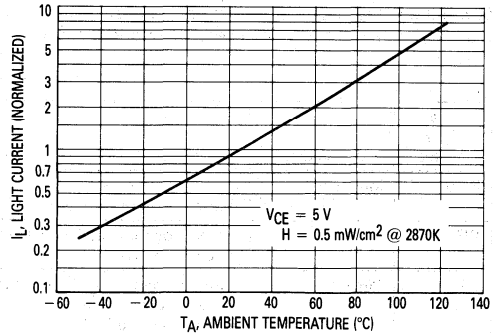

Figure 2. Normalized Light Current versus Temperature

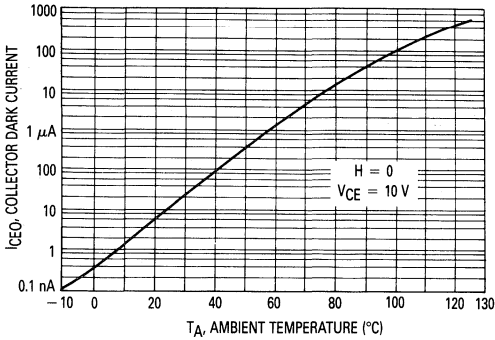

Figure 3. Dark Current versus Temperature

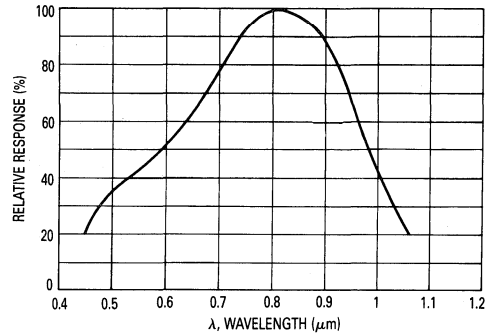

Figure 4. Constant Energy Spectral Response

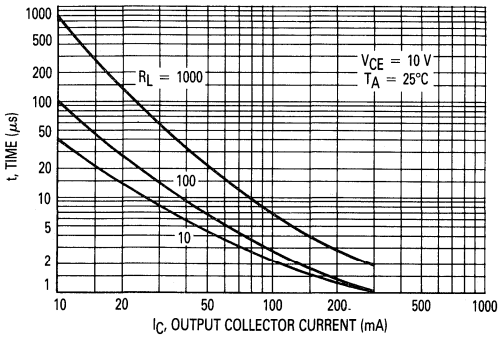

Figure 5. Typical Turn-On Switching Times

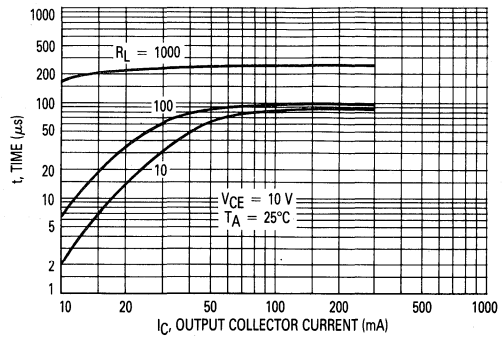

Figure 6. Typical Turn-Off Switching Times

MRDC400

ORDERING INFORMATION

This die is available with the packaging and visual inspection options listed below. To obtain the desired combination of options, it will be necessary to add a suffix to

the die type number in accordance with the information given in Table 1.

TABLE 1

| Die Type Suffix | Packaging | Description | Visual Inspection |
|-----------------|------------|--|--|
| None | Multi-Pak | Chips in waffle package (individual chip compartments) | 100% visually inspected Rejects removed |
| WP | Wafer Pak | Wafer-probed, unscribed, unbroken and heat sealed in plastic bag (rejects are inked) | Visual inspected by sample to a LTPD = 10 |
| CP | Circle Pak | Wafer-probed, mounted on sticky film, sawed through and heat sealed in plastic bag (rejects are inked) | Visual inspected by sample to a LTPD = 10 |

Photo Detector Chip

Triac Driver Output

... designed for use with IRED (MLEDC1000) to optically couple logic systems with power triacs to control equipment powered from 120 Vac and 240 Vac lines.

- Zero Voltage Crossing
- High Blocking Voltage — $V_{DRM} = 600$ V Min
- Metallization Compatible with Conventional Wire and Die Bonding Techniques
- Available in Chip or Wafer Form

MRDC600

PHOTO DETECTOR CHIP
TRIAC DRIVER
OUTPUT

MAXIMUM RATINGS ($T_A = 25^\circ\text{C}$ unless otherwise noted)

| Rating | Symbol | Value | Unit |
|--|-----------|-------------|------------------|
| Off-State Output Terminal Voltage | V_{DRM} | 600 | Volts |
| Peak Repetitive Current (PW = 100 μs , 120 pps) | I_T | 300 | mA |
| Peak Nonrepetitive Surge Current (PW = 10 ms) | I_{TSM} | 1.2 | A |
| Total Power Dissipation (Note 1) | P_D | 300 | mW |
| Operating Junction Temperature Range | T_J | -40 to +100 | $^\circ\text{C}$ |
| Storage Temperature Range | T_{stg} | -65 to +200 | $^\circ\text{C}$ |

STATIC ELECTRICAL CHARACTERISTICS ($T_A = 25^\circ\text{C}$ unless otherwise noted)

| Characteristic | Symbol | Min | Typ | Max | Unit |
|---|------------|-----|------|-----|------------------|
| Peak Blocking Current, Either Direction (Note 2) ($V_{DRM} = 600$ V) | I_{DRM1} | — | 60 | 500 | nA |
| Peak On-State Voltage, Either Direction ($I_{TM} = 100$ mA Peak) | V_{TM} | — | 1.8 | 3 | Volts |
| Critical Rate of Rise of Off-State Voltage | dv/dt | — | 1500 | — | V/ μs |
| Critical Rate of Rise of On-State Voltage | dv/dt | — | 0.15 | — | V/ μs |

OPTICAL CHARACTERISTICS ($T_A = 25^\circ\text{C}$ unless otherwise noted)

| | | | | | |
|---|----------|---|-----|----|--------------------|
| Radiation Flux Density ($V_{TM} = 3$ V, $R_L = 150$ Ω , $\lambda = 940$ nm) | H_{FT} | — | 5 | 10 | mW/cm ² |
| Holding Current, Either Direction ($H = 10$ mW/cm ² , $\lambda = 940$ nm) | I_H | — | 100 | — | μA |

ZERO CROSSING CHARACTERISTICS ($T_A = 25^\circ\text{C}$ unless otherwise noted)

| | | | | | |
|--|------------|---|-----|-----|---------------|
| Leakage in Inhibited State ($V_{DRM} = 400$ V, $H = 20$ mW/cm ² , $\lambda = 940$ nm) | I_{DRM2} | — | 100 | 300 | μA |
| Inhibit Voltage ($H = 20$ mW/cm ² , MT1-MT2 Voltage above which device will not trigger) | V_{IH} | — | 10 | 20 | V |

DIE SPECIFICATIONS

| Die Size Mils | Die Thickness Mils | Bond Pad Size Mils MT1-MT2 | Metallization | | Active Area Square Mils |
|------------------|-----------------------|-------------------------------|----------------------|---------------------|----------------------------|
| | | | Front ⁽³⁾ | Back ⁽⁴⁾ | |
| 45 x 45 | 8-10 | 4.6 Dia. | Al | Au | 1400 |

- NOTES: 1. Maximum power dissipation rating is determined with chip mounted on a header or lead frame using conventional Motorola Semiconductor assembly techniques.
 2. Test voltage must be applied within off state dv/dt rating.
 3. Thickness — a minimum of 10,000 \AA .
 4. Thickness — a minimum of 15,000 \AA .

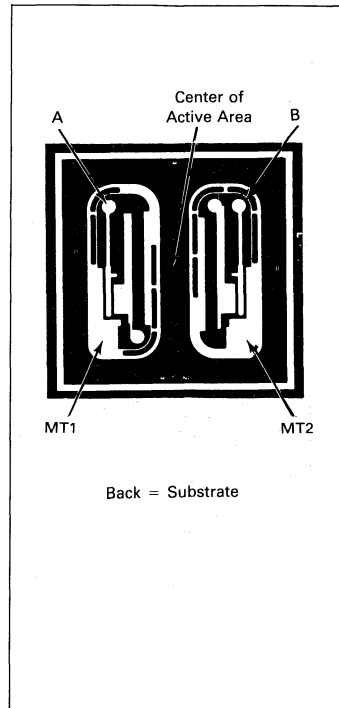

MRDC600

TYPICAL CHARACTERISTICS

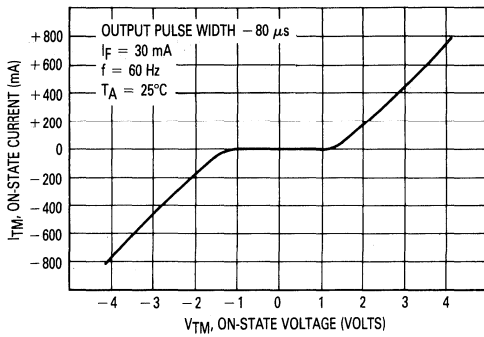

Figure 1. On-State Characteristics

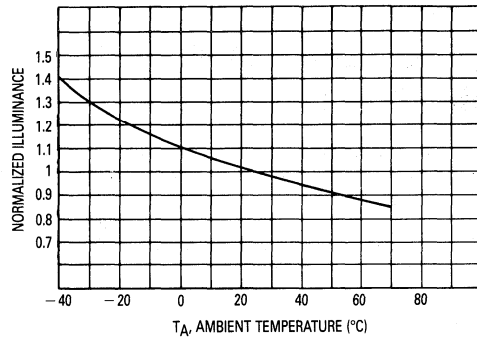

Figure 2. Illuminance versus Temperature

ORDERING INFORMATION

This die is available with the packaging and visual inspection options listed below. To obtain the desired combination of options, it will be necessary to add a suffix to

the die type number in accordance with the information given in Table 1.

TABLE 1

| Die Type Suffix | Packaging | Description | Visual Inspection |
|-----------------|------------|--|--|
| None | Multi-Pak | Chips in waffle package (individual chip compartments) | 100% visually inspected Rejects removed |
| WP | Wafer Pak | Wafer-probed, unscribed, unbroken and heat sealed in plastic bag (rejects are inked) | Visual inspected by sample to a LTPD = 10 |
| CP | Circle Pak | Wafer-probed, mounted on sticky film, sawed through and heat sealed in plastic bag (rejects are inked) | Visual inspected by sample to a LTPD = 10 |

Photo Detector Chip Triac Driver Output

... designed for use with IRED (MLEDC1000) to optically couple logic systems with power triacs to control equipment powered from 120 Vac and 240 Vac lines.

- Triac Driver Output
- High Blocking Voltage — $V_{DRM} = 400$ V Min
- Metallization Compatible with Conventional Wire and Die Bonding Techniques
- Available in Chip or Wafer Form

MRDC800

**PHOTO DETECTOR
 CHIP
 TRIAC DRIVER OUTPUT**

MAXIMUM RATINGS ($T_A = 25^\circ\text{C}$ unless otherwise noted)

| Rating | Symbol | Value | Unit |
|--|-------------------|-------------|------------------|
| Off-State Output Terminal Voltage | V_{DRM} | 400 | Volts |
| On-State RMS Current (Full Cycle 50 to 60 Hz) | $I_T(\text{RMS})$ | 100 | mA |
| Peak Nonrepetitive Surge Current (PW = 10 ms) | I_{TSM} | 1.2 | A |
| Total Power Dissipation ⁽¹⁾ | P_D | 300 | mW |
| Operating Junction Temperature Range | T_J | -40 to +85 | $^\circ\text{C}$ |
| Storage Temperature Range | T_{stg} | -65 to +200 | $^\circ\text{C}$ |

STATIC ELECTRICAL CHARACTERISTICS ($T_A = 25^\circ\text{C}$ unless otherwise noted)

| Characteristic | Symbol | Min | Typ | Max | Unit |
|--|------------|-----|-----|-----|---------------|
| Peak Blocking Current, Either Direction ⁽²⁾ ($V_{DRM} = 400$ V) | I_{DRM1} | — | 10 | 100 | nA |
| Peak On-State Voltage, Either Direction ($I_{TM} = 100$ mA Peak) | V_{TM} | — | 2.5 | 3 | Volts |
| Critical Rate of Rise of Off-State Voltage | dv/dt | — | 2 | — | μs |

OPTICAL CHARACTERISTICS ($T_A = 25^\circ\text{C}$ unless otherwise noted)

| Characteristic | Symbol | Min | Typ | Max | Unit |
|---|----------|-----|-----|-----|-------------------------|
| Radiation Flux Density ($V_{TM} = 3$ V, $R_L = 150$ Ω , $\lambda = 940$ nm) | H_{FT} | — | 5 | 10 | mW/cm^2 |
| Holding Current, Either Direction ($H = 10$ mW/cm^2 , $\lambda = 940$ nm) | I_H | — | 100 | — | μA |

DIE SPECIFICATIONS

| Die Size Mils | Die Thickness Mils | Bond Pad Size Mils | | Metallization | | Active Area Square Mils |
|------------------|-----------------------|--------------------|-------|----------------------|---------------------|----------------------------|
| | | MT1 | MT2 | Front ⁽³⁾ | Back ⁽⁴⁾ | |
| 40 x 40 | 8-10 | 4 x 5 | 4 x 5 | Al | Au | 1400 |

- NOTES: 1. Maximum power dissipation rating is determined with chip mounted on a header or lead frame using conventional Motorola Semiconductor assembly techniques.
 2. Test voltage must be applied within off state dv/dt rating.
 3. Thickness — a minimum of 10,000 Å.
 4. Thickness — a minimum of 15,000 Å.

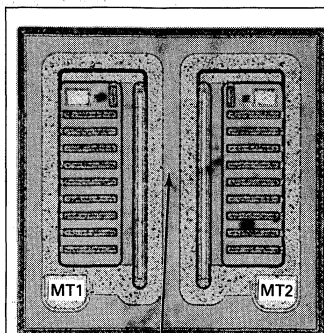

Center of Active Area

Back = Substrate

MT1 = MT2 = Main
 Terminals (Symmetric)

TYPICAL CHARACTERISTICS

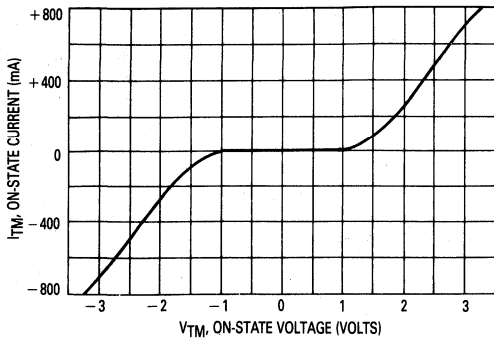

Figure 1. On-State Characteristics

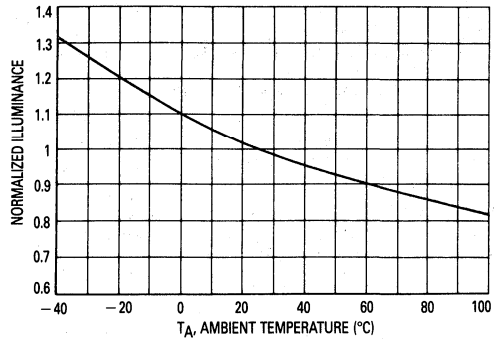

Figure 2. Illuminance versus Temperature

ORDERING INFORMATION

This die is available with the packaging and visual inspection options listed below. To obtain the desired combination of options, it will be necessary to add a suffix to

the die type number in accordance with the information given in Table 1.

TABLE 1

| Die Type Suffix | Packaging | Description | Visual Inspection |
|-----------------|------------|--|--|
| None | Multi-Pak | Chips in waffle package (individual chip compartments) | 100% visually inspected Rejects removed |
| WP | Wafer Pak | Wafer-probed, unscribed, unbroken and heat sealed in plastic bag (rejects are inked) | Visual inspected by sample to a LTPD = 10 |
| CP | Circle Pak | Wafer-probed, mounted on sticky film, sawed through and heat sealed in plastic bag (rejects are inked) | Visual inspected by sample to a LTPD = 10 |

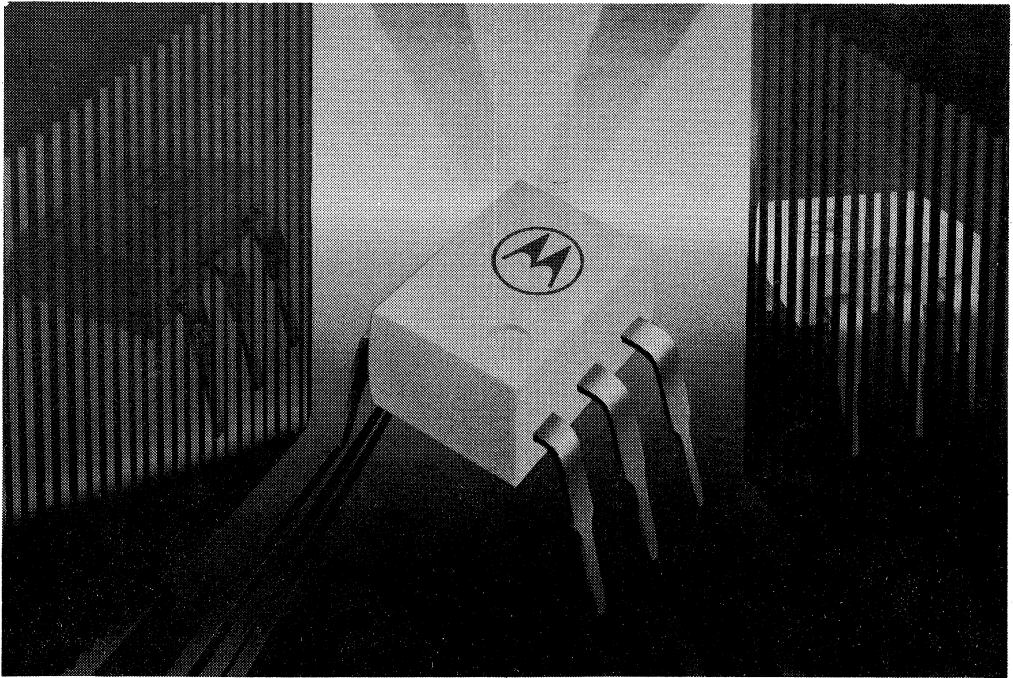

Applications Information

APPLICATIONS INFORMATION

| | | |
|--------|---|------|
| AN440 | Theory and Characteristics of Phototransistors | 9-3 |
| AN508 | Applications of Phototransistors in Electro-Optic Systems | 9-14 |
| AN571A | Isolation Techniques Using Optical Couplers | 9-28 |
| AN780A | Applications of the MOC3011 Triac Driver | 9-36 |
| AN846 | Basic Concepts of Fiber Optics and Fiber Optic Communications. | 9-42 |
| AN978 | Application of the Motorola VDE Approved Optocouplers | 9-62 |
| AN979 | Guidelines for Circuit Board Assembly of Motorola Case 349 Opto Products | 9-70 |
| AN982 | Applications of Zero Voltage Crossing Optically Isolated Triac Drivers | 9-72 |

THEORY AND CHARACTERISTICS OF PHOTOTRANSISTORS

Prepared By:
John Bliss

INTRODUCTION

Phototransistor operation is based on the sensitivity of a pn junction to radiant energy. If radiant energy of proper wave-length is made to impinge on a junction, the current through that junction will increase. This optoelectronic phenomenon has provided the circuit designer with a device for use in a wide variety of applications. However, to make optimum use of the phototransistor, the designer should have a sound grasp of its operating principles and characteristics.

HISTORY

The first significant relationships between radiation and electricity were noted by Gustav Hertz in 1887. Hertz observed that under the influence of light, certain surfaces were found to liberate electrons.

In 1900, Max Planck proposed that light contained energy in discrete bundles or packets which he called photons. Einstein formulated this theory in 1905, showing that the energy content of each photon was directly proportional to the light frequency:

$$E = hf, \quad (1)$$

where E is the photon energy,
h is Planck's constant, and
f is the light frequency.

Planck theorized that a metal had associated with it a work function, or binding energy for free electrons. If a photon could transfer its energy to a free electron, and that energy exceeded the work function, the electron could be liberated from the surface. The presence of an electric field could enhance this by effectively reducing the work function. Einstein extended Planck's findings by showing that the velocity, and hence the momentum of an emitted electron, depended on the work function and the light frequency.

PHOTO EFFECT IN SEMICONDUCTORS

Bulk Crystal

If light of proper wavelength impinges on a semiconductor crystal, the concentration of charge carriers is found to increase. Thus, the crystal conductivity will increase:

$$\sigma = q (\mu_e n + \mu_h p), \quad (2)$$

where σ is the conductivity,

q is the electron charge,

μ_e is the electron mobility,

μ_h is the hole mobility,

n is the electron concentration, and

p is the hole concentration.

The process by which charge-carrier concentration is increased is shown in Figure 1. The band structure of the semiconductor is shown, with an energy gap, or forbidden region, of E_g electron volts. Radiation from two light sources is shown striking the crystal. Light frequency f_1 is sufficiently high that its photon energy, hf_1 , is slightly greater than the energy gap. This energy is transferred to a bound electron at site one in the valence band, and the electron is excited to a higher energy level, site one in the conduction band, where it is free to serve as a current carrier. The hole left behind at site one in the valence band is also free to serve as a current carrier.

The photon energy of the lower-frequency light, hf_2 , is less than the band gap, and an electron freed from site two in the valence band will rise to a level in the forbidden region, only to release this energy and fall back into the valence band and recombine with a hole at site three.

The above discussion implies that the energy gap, E_g , represents a threshold of response to light. This is true, however, it is not an abrupt threshold. Throughout the photo-excitation process, the law of conservation of mo-

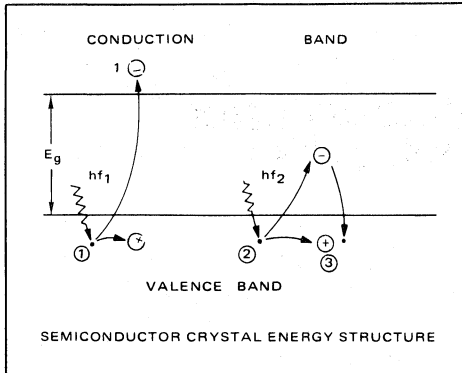

FIGURE 1 - Photoeffect in a Semiconductor

mentum applies. The momentum and density of hole-electron sites are highest at the center of both the valence and conduction bands, and fall to zero at the upper and lower ends of the bands. Therefore, the probability of an excited valence-band electron finding a site of like momentum in the conduction band is greatest at the center of the bands and lowest at the ends of the bands. Consequently, the response of the crystal to the impinging light is found to rise from zero at a photon energy of E_g electron volts, to a peak at some greater energy level, and then to fall to zero again at an energy corresponding to the difference between the bottom of the valence band and the top of the conduction band.

The response is a function of energy, and therefore of frequency, and is often given as a function of reciprocal frequency, or, more precisely, of wave length. An example is shown in Figure 2 for a crystal of cadmium-selenide. On the basis of the information given so far, it would seem reasonable to expect symmetry in such a curve; however, trapping centers and other absorption phenomena affect the shape of the curve¹.

The optical response of a bulk semiconductor can be modified by the addition of impurities. Addition of an acceptor impurity, which will cause the bulk material to become p-type in nature, results in impurity levels which lie somewhat above the top of the valence band. Photo-excitation can occur from these impurity levels to the conduction band, generally resulting in a shifting and reshaping of the spectral response curve. A similar modification of response can be attributed to the donor impurity levels in n-type material.

PN Junctions

If a pn junction is exposed to light of proper frequency, the current flow across the junction will tend to increase. If the junction is forward-biased, the net increase will be relatively insignificant. However, if the junction is reverse-biased, the change will be quite appreciable. Figure 3 shows the photo effect in the junction for a frequency well within the response curve for the device.

Photons create hole-electron pairs in the crystal on both sides of the junction. The transferred energy promotes the electrons into the conduction band, leaving the holes in the valence band. The applied external bias provides an electric field, \mathcal{E} , as shown in the figure. Thus the photo-induced electrons in the p-side conduction band will flow down the potential hill at the junction into the n-side and from there to the external circuit. Likewise, holes in the valence band of the n-side will flow across the junction into the p-side where they will add to the external current.

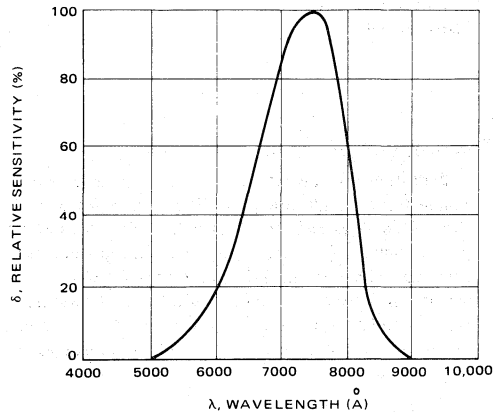

FIGURE 2 - Spectral Response of Cadmium Selenide

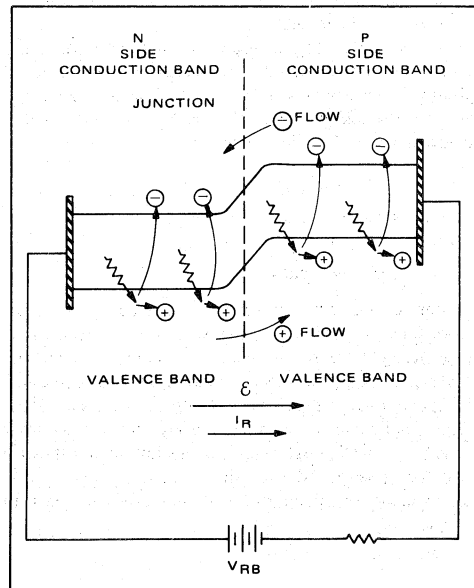

FIGURE 3 - Photo Effect in a Reverse-Biased PN Junction

1. See references for a detailed discussion of these.

Under dark conditions, the current flow through the reverse-biased diode is the reverse saturation current, I_0 . This current is relatively independent of the applied voltage (below breakdown) and is basically a result of the thermal generation of hole-electron pairs.

When the junction is illuminated, the energy transferred from photons creates additional hole-electron pairs. The number of hole-electron pairs created is a function of the light intensity.

For example, incident monochromatic radiation of H (watts/cm²) will provide P photons to the diode:

$$P = \frac{\lambda H}{hc} \quad (3)$$

where λ is the wavelength of incident light,
 h is Planck's constant, and
 c is the velocity of light.

The increase in minority carrier density in the diode will depend on P , the conservation of momentum restriction, and the reflectance and transmittance properties of the crystal. Therefore, the photo current, I_λ , is given by

$$I_\lambda = \eta F q A, \quad (4)$$

where η is the quantum efficiency or ratio of current carriers to incident photons,

F is the fraction of incident photons transmitted by the crystal,
 q is the charge of an electron, and
 A is the diode active area.

Thus, under illuminated conditions, the total current flow is

$$I = I_0 + I_\lambda \quad (5)$$

If I_λ is sufficiently large, I_0 can be neglected, and by using the spectral response characteristics and peak spectral sensitivity of the diode, the total current is given approximately by

$$I \approx \delta S_R H, \quad (6)$$

where δ is the relative response and a function of radiant wavelength,

S_R is the peak spectral sensitivity, and
 H is the incident radiation.

The spectral response for a silicon photo-diode is given in Figure 4.

Using the above relations, an approximate model of the diode is given in Figure 5. Here, the photo and thermally generated currents are shown as parallel current sources. C represents the capacitance of the reverse-biased junction while G represents the equivalent shunt conductance of the diode and is generally quite small. This model applies only for reverse bias, which, as mentioned above, is the normal mode of operation.

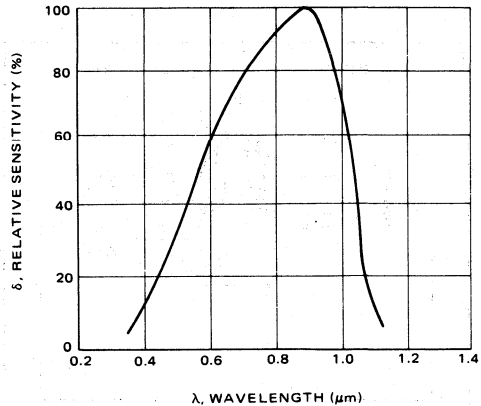

FIGURE 4 - Spectral Response of Silicon Photodiode

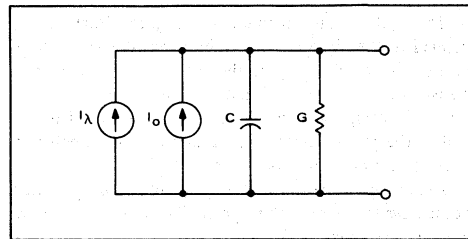

FIGURE 5 - Approximate Model of Photodiode

Photo Transistor

If the pn junction discussed above is made the collector-base diode of a bipolar transistor, the photo-induced current is the transistor base current. The current gain of the transistor will thus result in a collector-emitter current of

$$I_C = (h_{fe} + 1) I_\lambda, \quad (7)$$

where I_C is the collector current,

h_{fe} is the forward current gain, and
 I_λ is the photo induced base current.

The base terminal can be left floating, or can be biased up to a desired quiescent level. In either case, the collector-base junction is reverse biased and the diode current is the reverse leakage current. Thus, photo-stimulation will result in a significant increase in diode, or base current, and with current gain will result in a significant increase in collector current.

The energy-band diagram for the photo transistor is shown in Figure 6. The photo-induced base current is returned to the collector through the emitter and the external circuitry. In so doing, electrons are supplied to the base region by the emitter where they are pulled into the collector by the electric field \mathcal{E} .

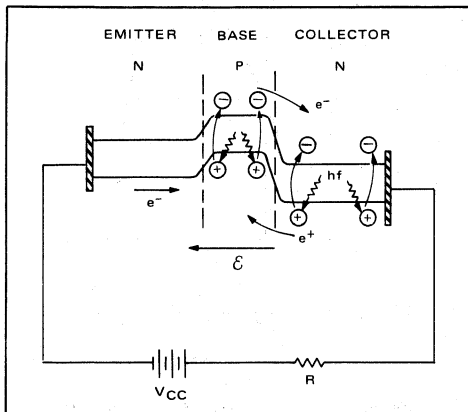

FIGURE 6 – Photoeffect in a Transistor

The model of the photo diode in Figure 5 might also be applied to the phototransistor, however, this would be severely limited in conveying the true characteristics of the transistor. A more useful and accurate model can be obtained by using the hybrid-pi model of the transistor and adding the photo-current generator between collector and base. This model appears in Figure 7.

Assuming a temperature of 25°C, and a radiation source at the wave length of peak response (i.e., $\delta = 1$), the following relations apply:

$$I_{\lambda} \approx \text{SRCBO} \cdot H, \quad (8a)$$

$$g_m = 40 i_c, \text{ and} \quad (8b)$$

$$r_{be} = h_{fe}/g_m, \quad (8c)$$

where SRCBO is the collector-base diode radiation sensitivity with open emitter,

g_m is the forward transconductance,

i_c is the collector current, and

r_{be} is the effective base-emitter resistance.

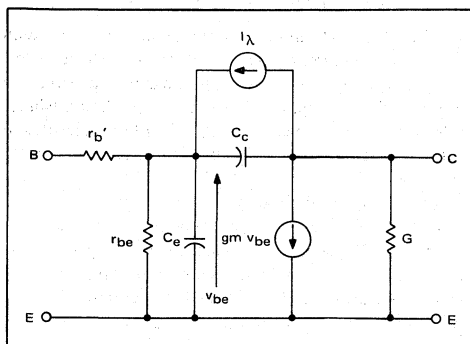

FIGURE 7 – Hybrid-pi Model of Phototransistor

In most cases $r'_b \ll r_{be}$, and can be neglected. The open-base operation is represented in Figure 8. Using this model, a feel for the high-frequency response of the device may be obtained by using the relationship

$$f_t \approx \frac{g_m}{2\pi C_e}, \quad (9)$$

where f_t is the device current-gain-bandwidth product.

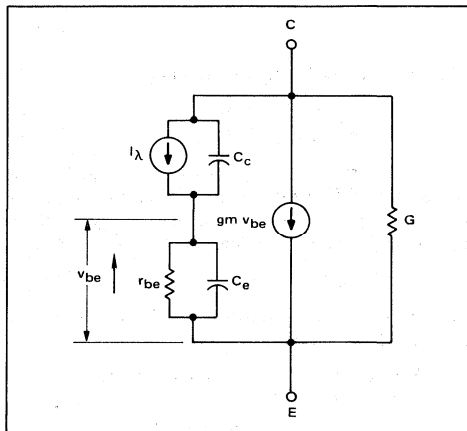

FIGURE 8 – Floating Base Approximate Model of Phototransistor

STATIC ELECTRICAL CHARACTERISTICS OF PHOTOTRANSISTORS

Spectral Response

As mentioned previously, the spectral response curve provides an indication of a device's ability to respond to radiation of different wave lengths. Figure 9 shows the spectral response for constant energy radiation for the Motorola MRD300 phototransistor series. As the figure indicates, peak response is obtained at about 8000 Å (Angstroms), or 0.8 μm .

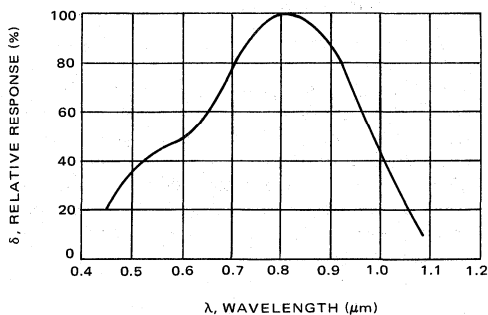

FIGURE 9 – Constant Energy Spectral Response for MRD300

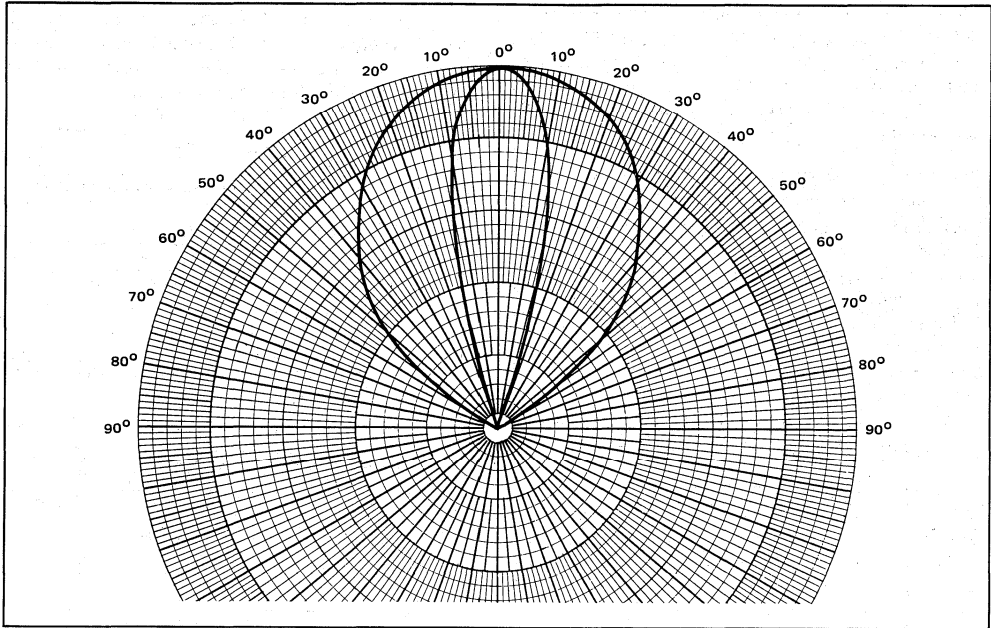

FIGURE 10 – Polar Response of MRD300. Inner Curve with Lens, Outer Curve with Flat Glass.

Angular Alignment

Lambert's law of illumination states that the illumination of a surface is proportional to the cosine of the angle between the normal to the surface and the direction of the radiation. Thus, the angular alignment of a photo-transistor and radiation source is quite significant. The cosine proportionality represents an ideal angular response. The presence of an optical lens and the limit of window size further affect the response. This information is best conveyed by a polar plot of the device response. Such a plot in Figure 10 gives the polar response for the MRD300 series.

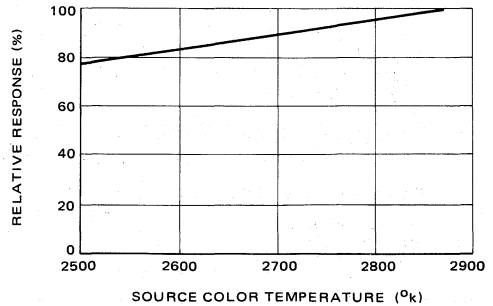

FIGURE 12 – Relative Response of MRD300 versus Color Temperature

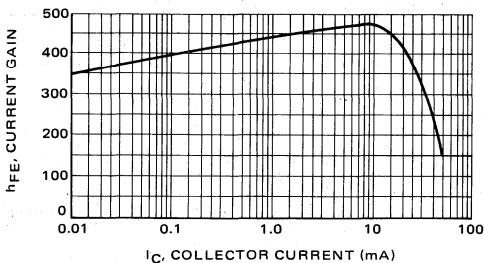

FIGURE 11 – DC Current Gain versus Collector Current

DC Current Gain

The sensitivity of a photo transistor is a function of the collector-base diode quantum efficiency and also of the dc current gain of the transistor. Therefore, the overall sensitivity is a function of collector current. Figure 11 shows the collector current dependence of dc current gain.

Color Temperature Response

In many instances, a photo transistor is used with a broad band source of radiation, such as an incandescent lamp. The response of the photo transistor is therefore dependent on the source color temperature. Incandescent

sources are normally operated at a color temperature of 2870°K, but, lower-color-temperature operation is not uncommon. It therefore becomes desirable to know the result of a color temperature difference on the photo sensitivity. Figure 12 shows the relative response of the MRD300 series as a function of color temperature.

Temperature Coefficient of I_p

A number of applications call for the use of phototransistors in temperature environments other than normal room temperature. The variation in photo current with temperature changes is approximately linear with a positive slope of about 0.667%/°C.

The magnitude of this temperature coefficient is primarily a result of the increase in h_{FE} versus temperature, since the collector-base photo current temperature coefficient is only about 0.1%/°C.

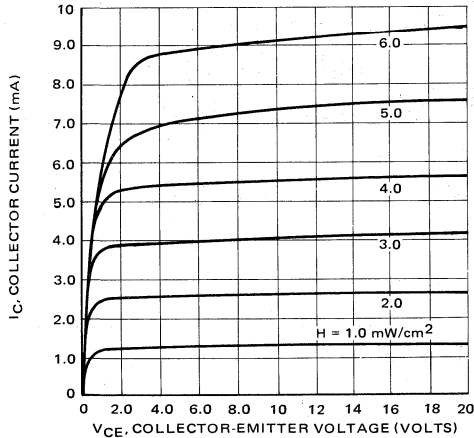

FIGURE 13 – Collector Characteristics for MRD300

Collector Characteristics

Since the collector current is primarily a function of impinging radiation, the effect of collector-emitter voltage, below breakdown, is small. Therefore, a plot of the I_C-V_{CE} characteristics with impinging radiation as a parameter, are very similar to the same characteristics with I_B as a parameter. The collector family for the MRD300 series appears in Figure 13.

Radiation Sensitivity

The capability of a given phototransistor to serve in a given application is quite often dependent on the radiation sensitivity of the device. The open-base radiation sensitivity for the MRD300 series is given in Figure 14. This indicates that the sensitivity is approximately linear with respect to impinging radiation. The additional capability of the MRD300 to be pre-biased gives rise to interest in the sensitivity as a function of equivalent base resistance. Figure 15 gives this relationship.

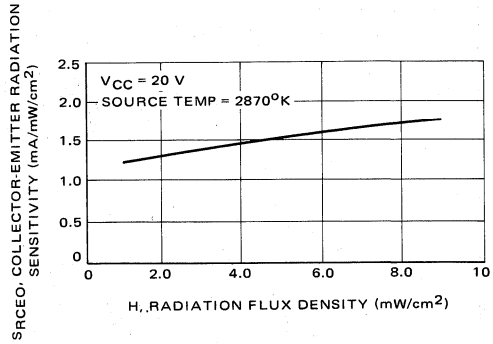

FIGURE 14 – Open Base Sensitivity versus Radiation for MRD300

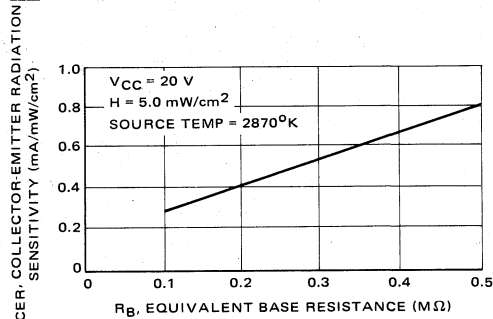

FIGURE 15 – Effect of Base Resistance on Sensitivity of MRD300

Capacitance

Junction capacitance is the significant parameter in determining the high frequency capability and switching speed of a transistor. The junction capacitances of the MRD300 as a function of junction voltages are given in Figure 16.

DYNAMIC CHARACTERISTICS OF PHOTOTRANSISTORS

Linearity

The variation of h_{FE} with respect to collector current results in a non-linear response of the photo transistor over

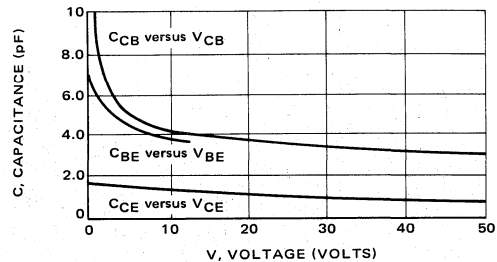

FIGURE 16 – Junction Capacitances versus Voltage for MRD300

large signal swings. However, the small-signal response is approximately linear. The use of a load line on the collector characteristic of Figure 13 will indicate the degree of linearity to be expected for a specific range of optical drive.

Frequency Response

The phototransistor frequency response, as referred to in the discussion of Figures 7 and 8, is presented in Figure 17. The device response is flat down to dc with the rolloff frequency dependent on the load impedance as well as on the device. The response is given in Figure 17 as the 3-dB frequency as a function of load impedance for two values of collector current.

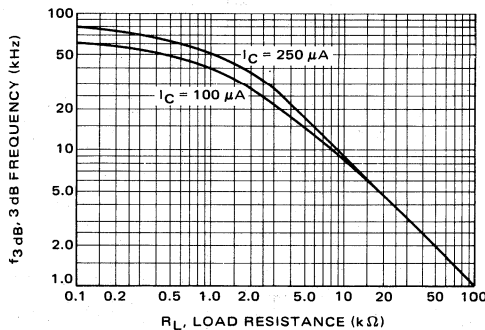

FIGURE 17 — 3 dB Frequency versus Load Resistance for MRD300

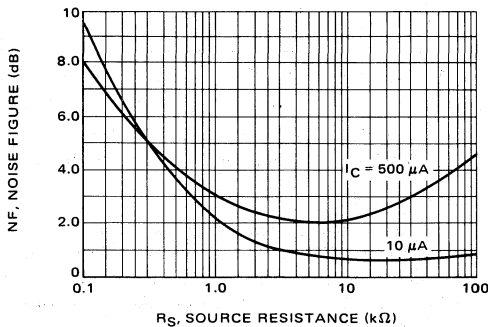

FIGURE 18 — MRD300 Noise Figure versus Source Resistance

Noise Figure

Although the usual operation of the phototransistor is in the floating base mode, a good qualitative feel for the device's noise characteristic can be obtained by measuring noise figure under standard conditions. The 1 kHz noise figure for the MRD300 is shown in Figure 18.

Small Signal h Parameters

As with noise figure, the small-signal h-parameters, measured under standard conditions, give a qualitative feel for

the device behavior. These are given as functions of collector current in Figure 19. With this information, the device can be analyzed in the standard hybrid model of Figure 20(a); by use of the conversions of Table I, the equivalent r-parameter model of Figure 20(b) can be used.

TABLE I — Parameter Conversions

$$h_{fb} = \frac{h_{fe}}{1 + h_{fe}}$$

$$r_c = \frac{h_{fe} + 1}{h_{oe}}$$

$$r_e = \frac{h_{re}}{h_{oe}}$$

$$r_b = h_{ie} - \frac{h_{re}(1 + h_{fe})}{h_{oe}}$$

SWITCHING CHARACTERISTICS OF PHOTOTRANSISTORS

In switching applications, two important requirements of a transistor are:

- (1) speed
- (2) ON voltage

Since some optical drives for phototransistors can provide fast light pulses, the same two considerations apply.

Switching Speed

If reference is made to the model of Figure 8, it can be seen that a fast rise in the current I_λ will not result in an equivalent instantaneous increase in collector-emitter current. The initial flow of I_λ must supply charging current to C_{CB} and C_{BE} . Once these capacitances have been charged, I_λ will flow through r_{be} . Then the current generator, $g_m \cdot v_{be}$, will begin to supply current. During turn-off, a similar situation occurs. Although I_λ may instantaneously drop to zero, the discharge of C_{CB} and C_{BE} through r_{be} will maintain a current flow through the collector. When the capacitances have been discharged, V_{be} will fall to zero and the current, $g_m \cdot V_{be}$, will likewise drop to zero. (This discussion assumes negligible leakage currents). These capacitances therefore result in turn-on and turn-off delays, and in rise and fall times for switching applications just as found in conventional bipolar switching transistors. And, just as with conventional switching, the times are a function of drive. Figure 21 shows the collector current (or drive) dependence of the turn-on delay and rise times. As indicated the delay time is dependent on the device only; whereas the rise-time is dependent on both the device and the load.

If a high-intensity source, such as a xenon flash lamp, is used for the optical drive, the device becomes optically saturated unless large optical attenuation is placed between source and detector. This can result in a significant storage time during the turn off, especially in the floating-base mode since stored charge has no direct path out of the

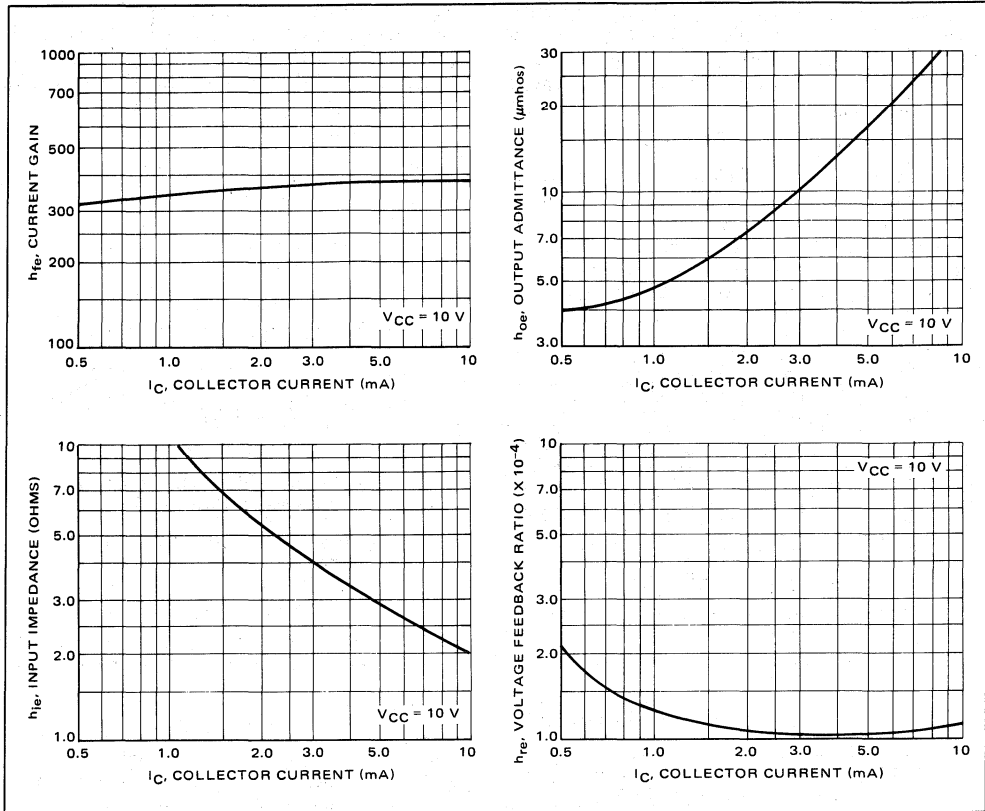

FIGURE 19 – 1 kHz h-Parameters versus Collector Current for MRD300

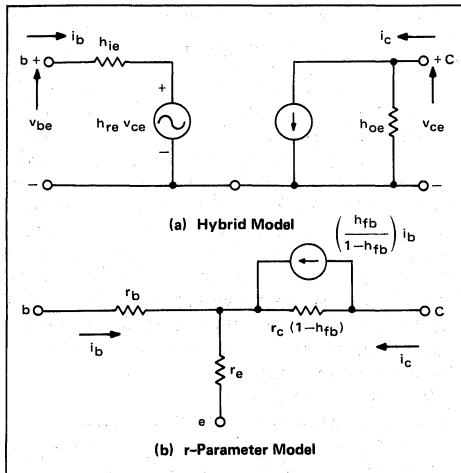

FIGURE 20 – Low Frequency Analytical Models of Phototransistor Without Photo Current Generator

base region. However, if a non-saturating source, such as a GaAs diode, is used for switching drive, the storage, or turn-off delay time is quite low as shown in Figure 22.

Saturation Voltage

An ideal switch has zero ON impedance, or an ON voltage drop of zero. The ON saturation voltage of the MRD300 is relatively low, approximately 0.2 volts. For a given collector current, the ON voltage is a function of drive, and is shown in Figure 23.

APPLICATIONS OF PHOTOTRANSISTORS

As mentioned previously, the phototransistor can be used in a wide variety of applications. Figure 24 shows two phototransistors in a series-shunt chopper circuit. As Q1 is switched ON, Q2 is OFF, and when Q1 is switched OFF, Q2 is driven ON.

Logic circuitry featuring the high input/output electrical isolation of photo transistors is shown in Figure 25.

Figure 26 shows a linear application of the phototransistor. As mentioned previously, the linearity is obtained for small-signal swings.

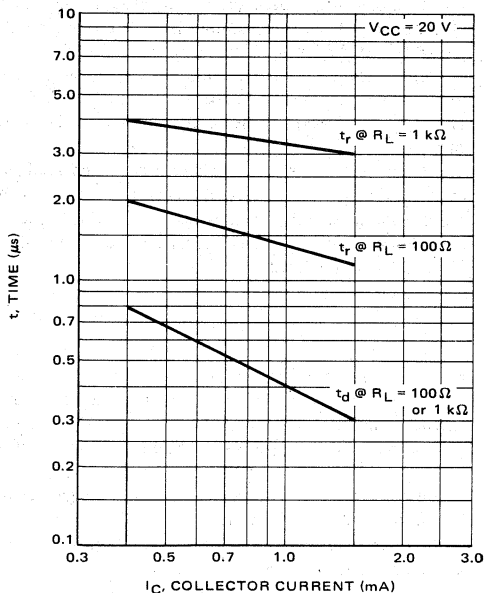

FIGURE 21 – Switching Delay and Rise Times for MRD300

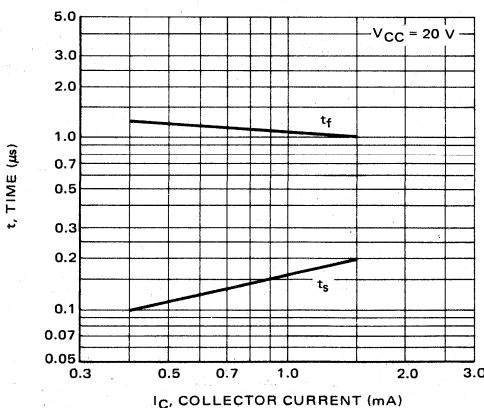

FIGURE 22 – Switching Storage and Fall Times for MRD300

A double-pole, single-throw relay is shown in Figure 27. In general, the phototransistor can be used in counting circuitry, level indications, alarm circuits, tachometers, and various process controls.

Conclusion

The phototransistor is a light-sensitive active device of moderately high sensitivity and relatively high speed. Its response is both a function of light intensity and wavelength, and behaves basically like a standard bipolar transistor with an externally controlled collector-base leakage current.

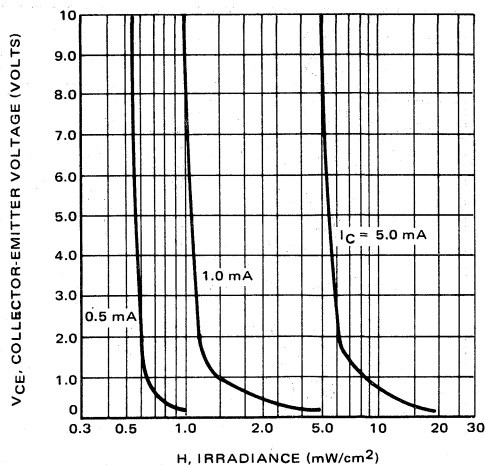

FIGURE 23 – Collector Emitter Saturation Voltage as a Function of Irradiance for MRD300

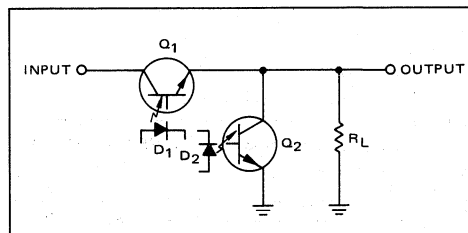

FIGURE 24 – Series-Shunt Chopper Circuit Using MRD300 Phototransistors and GaAs Light Emitting Diodes (LEDs)

APPENDIX I

Radiant energy covers a broad band of the electromagnetic spectrum. A relatively small segment of the band is the spectrum of visible light. A portion of the electromagnetic spectrum including the range of visible light is shown in Figure I-1.

The portion of radiant flux, or radiant energy emitted per unit time, which is visible is referred to as luminous flux. This distinction is due to the inability of the eye to respond equally to like power levels of different visible wavelengths. For example, if two light sources, one green and one blue are both emitting like wattage, the eye will perceive the green light as being much brighter than the blue. Consequently, when speaking of visible light of varying color, the watt becomes a poor measure of brightness. A more meaningful unit is the lumen. In order to obtain a clear understanding of the lumen, two other definitions are required.

The first of these is the standard source (Fig. I-2). The standard source, adopted by international agreement, con-

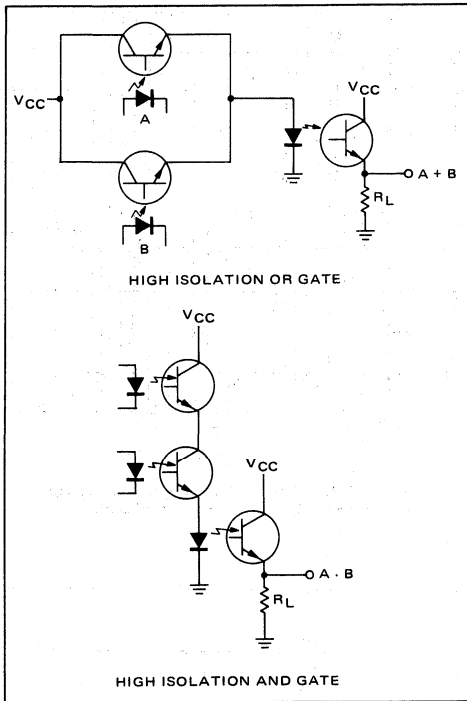

FIGURE 25 — Logic Circuits Using the MRD300 and LEDs

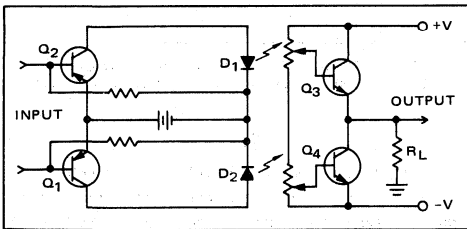

FIGURE 26 — Small Signal Linear Amplifier Using MRD300 and LEDs

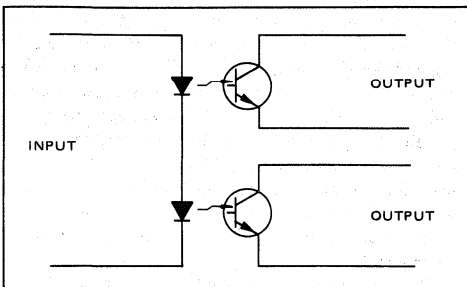

FIGURE 27 — DPST Relay Using MRD300s and LEDs

sists of a segment of fused thoria immersed in a chamber of platinum. When the platinum is at its melting point, the light emitted from the chamber approximates the radiation of a black body. The luminous flux emitted by the source is dependent on the aperture and cone of radiation. The cone of radiation is measured in terms of the solid angle.

The concept of a solid angle comes from spherical geometry. If a point is enclosed by a spherical surface and a set of radial lines define an area on the surface, the radial lines also subtend a solid angle. This angle, ω , is shown in Figure I-3, and is defined as

$$\omega = \frac{A}{r^2}, \quad (I-1)$$

where A is the described area and r is the spherical radius.

If the area A is equal to r^2 , then the solid angle subtended is one unit solid angle or one steradian, which is nothing more than the three-dimensional equivalent of a radian.

With the standard source and unit solid angle established, the lumen can be defined.

A lumen is the luminous flux emitted from a standard source and included within one steradian.

Using the concept of the lumen, it is now possible to define other terms of illumination.

Illuminance

If a differential amount of luminous flux, dF , is impinging on a differential area, dA , the illuminance, E , is given by

$$E = \frac{dF}{dA} \quad (I-2)$$

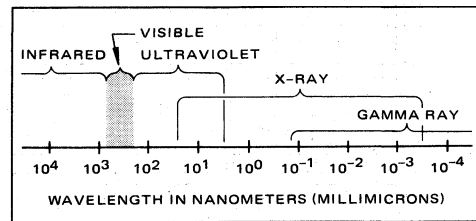

FIGURE I-1 — Portion of Electromagnetic Spectrum

Illuminance is most often expressed in lumens per square foot, or foot-candles. If the illuminance is constant over the area, (I-2) becomes

$$E = F/A. \quad (I-3)$$

Luminous Intensity

When the differential flux, dF , is emitted through a differential solid angle, $d\omega$, the luminous intensity, I , is given by

$$I = \frac{dF}{d\omega} \quad (I-4)$$

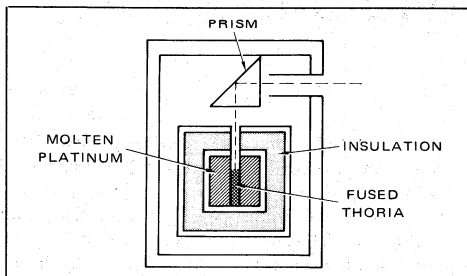

FIGURE I-2 - International Standard Source

Luminous intensity is most often expressed in lumens per steradian or candela. If the luminous intensity is constant with respect to the angle of emission, (I-4) becomes:

$$I = \frac{F}{\omega} \quad (I-5)$$

If the wavelength of visible radiation is varied, but the illumination is held constant, the radiative power in watts will be found to vary. This again illustrates the poor quality of the watt as a measure of illumination. A relation between illumination and radiative power must then be specified at a particular frequency. The point of specification has been taken to be at a wavelength of 0.555 μm , which is the peak of spectral response of the human eye. At this wavelength, 1 watt of radiative power is equivalent to 680 lumens.

**APPENDIX II
OPTOELECTRONIC DEFINITIONS**

- F, Luminous Flux: Radiant flux of wavelength within the band of visible light.
Lumen: The luminous flux emitted from a standard source and included within one steradian (solid angle equivalent of a radian).
- H, Radiation Flux Density (Irradiance): The total incident radiation energy measured in power per unit area (e.g., mW/cm^2).
- E, Luminous Flux Density (Illuminance): Radiation flux density of wavelength within the band of visible light. Measured in lumens/ ft^2 or foot candles. At the wavelength of peak response of the human eye. 0.555 μm ($0.555 \times 10^{-6}\text{m}$), 1 watt of radiative power is equivalent to 680 lumens.
- SR, Radiation Sensitivity: The ratio of photo-induced current to incident radiant energy, the latter measured at the plane of the lens of the photo device.
- SI, Illumination Sensitivity: The ratio of photo-induced current to incident luminous energy, the latter measured at the plane of the lens of the photo device.

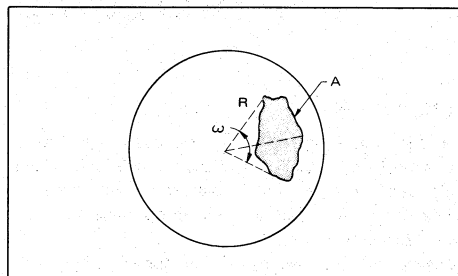

FIGURE I-3 - Solid Angle, ω

Spectral Response: Sensitivity as a function of wavelength of incident energy. Usually normalized to peak sensitivity.

Constants

- Planck's constant: $h = 4.13 \times 10^{-15} \text{ eV}\cdot\text{s}$.
- electron charge: $q = 1.60 \times 10^{-19} \text{ coulomb}$.
- velocity of light: $c = 3 \times 10^8 \text{ m/s}$.

Illumination Conversion Factors

| Multiply | By | To Obtain |
|-------------------------|-----------------------|-------------------------|
| lumens/ ft^2 | 1 | ft. candles |
| lumens/ ft^2 * | 1.58×10^{-3} | mW/cm^2 |
| candlepower | 4π | lumens |

*At 0.555 μm .

BIBLIOGRAPHY AND REFERENCES

1. Fitchen, Franklin C., Transistor Circuit Analysis and Design, D. Van Nostrand Company, Inc., Princeton 1962.
2. Hunter, Lloyd P., ed., Handbook of Semiconductor Electronics, Sect 5., McGraw-Hill Book Co., Inc., New York 1962.
3. Jordan, A.G. and A.G. Milnes, "Photoeffect on Diffused PN Junctions with Integral Field Gradients", IRE Transactions on Electron Devices, October 1960.
4. Millman, Jacob, Vacuum-tube and Semiconductor Electronics, McGraw-Hill Book Co., Inc., New York 1958.
5. Sah, C.T., "Effect of Surface Recombination and Channel on PN Junction and Transistor Characteristics", IRE Transactions on Electron Devices, January 1962.
6. Sears, F.W. and M.W. Zemansky, University Physics, Addison-Wesley Publishing Co., Inc., Reading, Massachusetts 1962.
7. Shockley, William, Electrons and Holes in Semiconductors, D. Van Nostrand Company, Inc., Princeton 1955.

APPLICATIONS OF PHOTOTRANSISTORS IN ELECTRO-OPTIC SYSTEMS

INTRODUCTION

A phototransistor is a device for controlling current flow with light. Basically, any transistor will function as a phototransistor if the chip is exposed to light, however, certain design techniques are used to optimize the effect in a phototransistor.

Just as phototransistors call for special design techniques, so do the circuits that use them. The circuit designer must supplement his conventional circuit knowledge with the terminology and relationships of optics and radiant energy. This note presents the information necessary to supplement that knowledge. It contains a short review of phototransistor theory and characteristics, followed by a detailed discussion of the subjects of irradiance, illuminance, and optics and their significance to phototransistors. A distinction is made between low-frequency/steady-state design and high-frequency design. The use of the design information is then demonstrated with a series of typical electro-optic systems.

PHOTOTRANSISTOR THEORY¹

Phototransistor operation is a result of the photo-effect in solids, or more specifically, in semiconductors. Light of a proper wavelength will generate hole-electron pairs within the transistor, and an applied voltage will cause these carriers to move, thus causing a current to flow. The intensity of the applied light will determine the number of carrier pairs generated, and thus the magnitude of the resultant current flow.

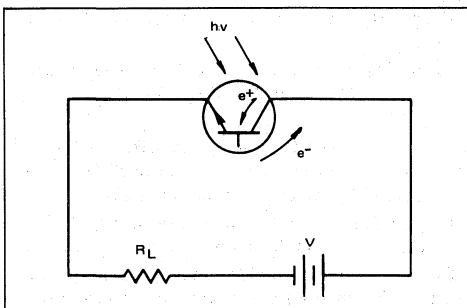

FIGURE 1 — Photo-Generated Carrier Movement in a Phototransistor

In a phototransistor the actual carrier generation takes place in the vicinity of the collector-base junction. As shown in Figure 1 for an NPN device, the photo-generated holes will gather in the base. In particular, a hole generated in the base will remain there, while a hole generated in the collector will be drawn into the base by the strong field at the junction. The same process will result in electrons tending to accumulate in the collector. Charge will not really accumulate however, and will try to evenly distribute throughout the bulk regions. Consequently, holes will diffuse across the base region in the direction of the emitter junction. When they reach the junction they will be injected into the emitter. This in turn will cause the emitter to inject electrons into the base. Since the emitter injection efficiency is much larger than the base injection efficiency, each injected hole will result in many injected electrons.

It is at this point that normal transistor action will occur. The emitter injected electrons will travel across the base and be drawn into the collector. There, they will combine with the photo-induced electrons in the collector to appear as the terminal collector current.

Since the actual photogeneration of carriers occurs in the collector base region, the larger the area of this region, the more carriers are generated, thus, as Figure 2 shows, the transistor is so designed to offer a large area to impinging light.

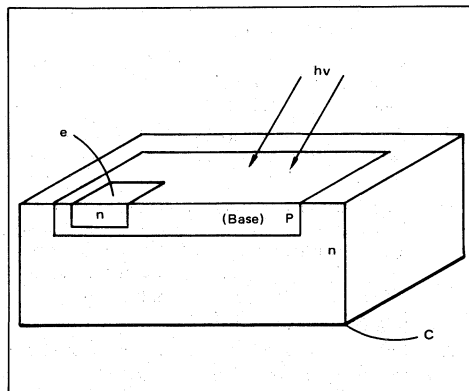

FIGURE 2 — Typical Double-Diffused Phototransistor Structure

¹For a detailed discussion see Motorola Application Note AN-440, "Theory and Characteristics of Phototransistors."

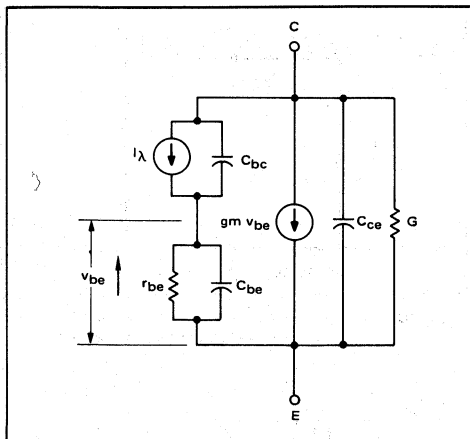

FIGURE 3 – Floating Base Approximate Model of Phototransistor

PHOTOTRANSISTOR STATIC CHARACTERISTICS

A phototransistor can be either a two-lead or a three-lead device. In the three-lead form, the base is made electrically available, and the device may be used as a standard bipolar transistor with or without the additional capability of sensitivity to light. In the two-lead form the base is not electrically available, and the transistor can only be used with light as an input. In most applications, the only drive to the transistor is light, and so the two-lead version is the most prominent.

As a two-lead device, the phototransistor can be modeled as shown in Figure 3. In this circuit, current generator I_λ represents the photo generated current and is approximately given by

$$I_\lambda = \eta F q A \tag{1}$$

where

η is the quantum efficiency or ratio of current carriers to incident photons,

F is the fraction of incident photons transmitted by the crystal,

q is the electronic charge, and

A is the active area.

The remaining elements should be recognized as the component distribution in the hybrid-pi transistor model. Note that the model of Figure 3 indicates that under dark conditions, I_λ is zero and so v_{be} is zero. This means that the terminal current $I \approx g_m v_{be}$ is also zero.

In reality there is a thermally generated leakage current, I_Q , which shunts I_λ . Therefore, the terminal current will be non-zero. This current, I_{CEO} , is typically on the order of 10 nA at room temperature and may in most cases be neglected.

As a three lead device, the model of Figure 3 need only have a resistance, r_b' , connected to the junction of C_{bc} and C_{be} . The other end of this resistance is the base terminal. As mentioned earlier, the three lead phototransistor is less common than the two lead version. The only advantages of having the base lead available are to stabilize the device operation for significant temperature excursions, or to use the base for unique circuit purposes.

Mention is often made of the ability to optimize a phototransistor's sensitivity by using the base. The idea is that the device can be electrically biased to a collector current at which hFE is maximum. However, the introduction of any impedance into the base results in a net decrease in photo sensitivity. This is similar to the effect noticed when I_{CEO} is measured for a transistor and found to be greater than I_{CER} . The base-emitter resistor shunts some current around the base-emitter junction, and the shunted current is never multiplied by hFE .

Now when the phototransistor is biased to peak hFE , the magnitude of base impedance is low enough to shunt an appreciable amount of photo current around the base-emitter. The result is actually a lower device sensitivity than found in the open base mode.

Spectral Response – As mentioned previously, a transistor is sensitive to light of a proper wavelength. Actually, response is found for a range of wavelengths. Figure 4 shows the normalized response for a typical phototransistor series (Motorola MRD devices) and indicates that peak response occurs at a wavelength of 0.8 μm . The warping in the response curve in the vicinity of 0.6 μm results from adjoining bands of constructive and destructive interference in the SiO_2 layer covering the transistor surface.

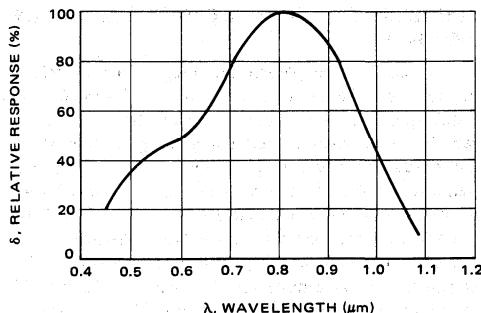

FIGURE 4 – Constant Energy Spectral Response for MRD Phototransistor Series

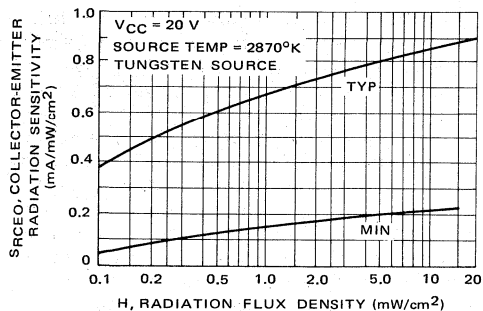

FIGURE 5 — Radiation Sensitivity for MRD450

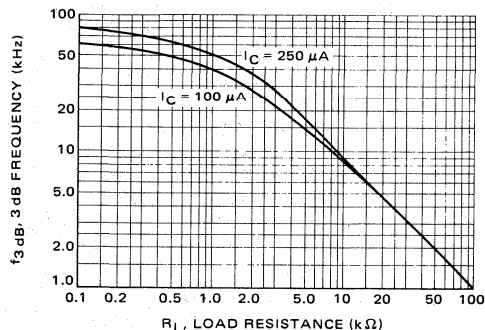

FIGURE 7 — 3 dB Frequency versus Load Resistance for MRD Phototransistor Series

Radiation Sensitivity — The absolute response of the MRD450 phototransistor to impinging radiation is shown in Figure 5. This response is standardized to a tungsten source operating at a color temperature of 2870°K. As subsequent discussion will show, the transistor sensitivity is quite dependent on the source color temperature.

Additional static characteristics are discussed in detail in AN-440, and will not be repeated here.

LOW-FREQUENCY AND STEADY-STATE DESIGN APPROACHES

For relatively simple circuit designs, the model of Figure 3 can be replaced with that of Figure 6. The justification for eliminating consideration of device capacitance is based on restricting the phototransistor's use to d.c. or low frequency applications. The actual frequency range of validity is also a function of load resistance. For example, Figure 7 shows a plot of the 3 dB response frequency as a function of load resistance.

Assume a modulated light source is to drive the phototransistor at a maximum frequency of 10 kHz. If the resultant photo current is 100 μA, Figure 7 shows a 3-dB frequency of 10 kHz at a load resistance of 8 kilohms. Therefore, in this case, the model of Figure 6 can be used with acceptable results for a load less than 8

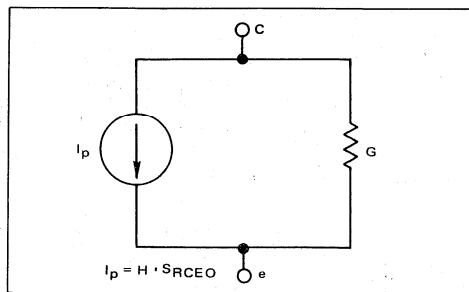

FIGURE 6 — Low-Frequency and Steady-State Model for Floating-Base Phototransistor

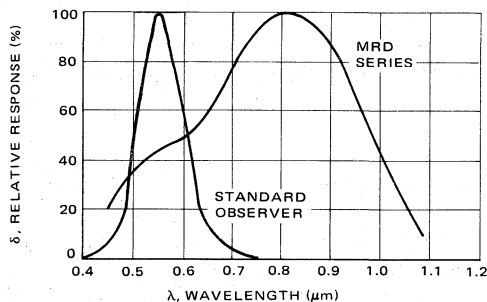

FIGURE 8 — Spectral Response for Standard Observer and MRD Series

kilohms. For larger loads, the hybrid-pi model must be used.

For the remainder of the discussion of low frequency and steady state design, it is assumed that the simplified model of Figure 6 is valid.

RADIATION AND ILLUMINATION SOURCES

The effect of a radiation source on a photo-transistor is dependent on the transistor spectral response and the spectral distribution of energy from the source. When discussing such energy, two related sets of terminology are available. The first is radiometric which is a physical system; the second is photometric which is a physiological system.

The photometric system defines energy relative to its visual effect. As an example, light from a standard 60 watt-bulb is certainly visible, and as such, has finite photometric quantity, whereas radiant energy from a 60-watt resistor is not visible and has zero photometric quantity. Both items have finite radiometric quantity.

The defining factor for the photometric system is the spectral response curve of a standard observer. This is shown in Figure 8 and is compared with the spectral response of the MRD series. The defining spectral response of the radiometric system can be imagined as unit response for all wavelengths.

A comparison of the terminology for the two systems is given in Table I.

There exists a relationship between the radiometric and photometric quantities such that at a wavelength of 0.55 μm, the wavelength of peak response for a standard observer, one watt of radiant flux is equal to 680 lumens of luminous flux. For a broadband of radiant flux, the visually effective, or photometric flux is given by:

$$F = K \int P(\lambda) \delta(\lambda) d\lambda \quad (2a)$$

where

K is the proportionality constant (of 680 lumens/watt),

P(λ) is the absolute spectral distribution of radiant flux,

δ(λ) is the relative response of the standard observer,

and

dλ is the differential wavelength,

A similar integral can be used to convert incident radiant flux density, or irradiance, to illuminance:

$$E = K \int H(\lambda) \delta(\lambda) d\lambda \quad (2b)$$

In Equation(2b) if H(λ) is given in watts/cm², E will be in lumens/cm². To obtain E in footcandles (lumens/ft²), the proportionality constant becomes

$$K = 6.3 \times 10^5 \text{ footcandles/mW/cm}^2$$

Fortunately, it is usually not necessary to perform the above integrations. The photometric effect of a radiant source can often be measured directly with a photometer.

Unfortunately, most phototransistors are specified for use with the radiometric system. Therefore, it is often necessary to convert photometric source data, such as the candle power rating of an incandescent lamp to radiometric data. This will be discussed shortly.

GEOMETRIC CONSIDERATIONS

In the design of electro-optic systems, the geometrical relationships are of prime concern. A source will effectively appear as either a point source, or an area source, depending upon the relationship between the size of the source and the distance between the source and the detector.

Point Sources – A point source is defined as one for which the source diameter is less than ten percent of the distance between the source and the detector, or,

$$\alpha < 0.1r, \quad (3)$$

where

α is the diameter of the source, and

r is the distance between the source and the detector.

Figure 9 depicts a point source radiating uniformly in every direction. If equation (3) is satisfied, the detector area, AD, can be approximated as a section of the area of a sphere of radius r whose center is the point source.

The solid angle, ω, in steradians² subtended by the detector area is

$$\omega = \frac{AD}{r^2} \quad (4)$$

Since a sphere has a surface area of 4πr², the total solid angle of a sphere is

$$\omega_S = \frac{4\pi r^2}{r^2} = 4\pi \text{ steradians.}$$

Table II lists the design relationships for a point source in terms of both radiometric and photometric quantities.

The above discussion assumes that the photodetector is aligned such that its surface area is tangent to the sphere with the point source at its center. It is entirely possible that the plane of the detector can be inclined from the

TABLE I – Radiometric and Photometric Terminology

| Description | Radiometric | Photometric |
|---|---|--|
| Total Flux | Radiant Flux, P, in Watts | Luminous Flux, F, in Lumens |
| Emitted Flux Density at a Source Surface | Radiant Emittance, W, in Watts/cm ² | Luminous Emittance, L, in Lumens/ft ² (foot-lamberts), or lumens/cm ² (Lamberts) |
| Source Intensity (Point Source) | Radiant Intensity, I _r , in Watts/Steradian | Luminous Intensity, I _L , in Lumens/Steradian (Candle) |
| Source Intensity (Area Source) | Radiance, B _r , in (Watts/Steradian) / cm ² | Luminance, B _L , in (Lumens/Steradian) / ft ² (footlambert) |
| Flux Density Incident on a Receiver Surface | Irradiance, H, in Watts/cm ² | Illuminance, E, in Lumens/ft ² (footcandle) |

TABLE II – Point Source Relationships

| Description | Radiometric | Photometric |
|-----------------------------------|--|--|
| Point Source Intensity | I _r , Watts/Steradian | I _L , Lumens/Steradian |
| Incident Flux Density | H (Irradiance) = $\frac{I_r}{r^2}$, watts/distance ² | E (Illuminance) = $\frac{I_L}{r^2}$, lumens/distance ² |
| Total Flux Output of Point Source | P = 4πI _r Watts | F = 4πI _L Lumens |

TABLE III – Design Relationships for an Area Source

| Description | Radiometric | Photometric |
|-----------------------|---|--|
| Source Intensity | B _r , Watts/cm ² /steradian | B _L , Lumens/cm ² /steradian |
| Emitted Flux Density | W = πB _r , Watts/cm ² | L = πB _L , Lumens/cm ² |
| Incident Flux Density | H = $\frac{B_r A_s}{r^2 + (d/2)^2}$, Watts/cm ² | E = $\frac{B_L A_s}{r^2 + (d/2)^2}$, Lumens/cm ² |

² Steradian: The solid equivalent of a radian.



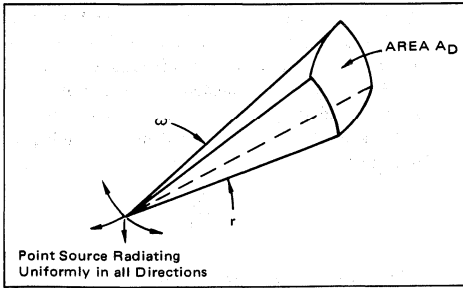

FIGURE 9 – Point Source Geometry

tangent plane. Under this condition, as depicted in Figure 10, the incident flux density is proportional to the cosine of the inclination angle, ϕ . Therefore,

$$H = \frac{I_r}{r^2} \cos \phi, \text{ and} \quad (5a)$$

$$E = \frac{I_L}{r^2} \cos \phi. \quad (5b)$$

AREA SOURCES

When the source has a diameter greater than 10 percent of the separation distance,

$$\alpha \geq 0.1r, \quad (6)$$

it is considered to be an area source. This situation is shown in Figure 11. Table III lists the design relationships for an area source.

A special case that deserves some consideration occurs when

$$\frac{\alpha}{2} \gg r, \quad (7)$$

that is, when the detector is quite close to the source. Under this condition,

$$H = \frac{B_r A_s}{r^2 + \left(\frac{\alpha}{2}\right)^2} \approx \frac{B_r A_s}{\left(\frac{\alpha}{2}\right)^2}, \quad (8)$$

but, the area of the source,

$$A_s = \pi \left(\frac{\alpha}{2}\right)^2, \quad (9)$$

Therefore,

$$H \approx B_r \pi = W, \quad (10)$$

That is, the emitted and incident flux densities are equal. Now, if the area of the detector is the same as the area of the source, and equation (7) is satisfied, the total incident energy is approximately the same as the total

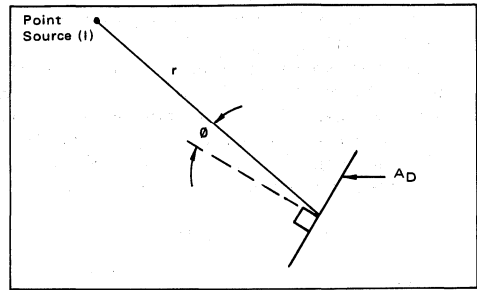

FIGURE 10 – Detector Not Normal to Source Direction

radiated energy, that is, unity coupling exists between source and detector.

LENS SYSTEMS

A lens can be used with a photodetector to effectively increase the irradiance on the detector. As shown in Figure 12a, the irradiance on a target surface for a point source of intensity, I, is

$$H = I/d^2, \quad (11)$$

where d is the separation distance.

In Figure 12b a lens has been placed between the source and the detector. It is assumed that the distance d' from the source to the lens is approximately equal to d:

$$d' \approx d, \quad (12)$$

and the solid angle subtended at the source is sufficiently small to consider the rays striking the lens to be parallel.

If the photodetector is circular in area, and the distance from the lens to the detector is such that the image of the source exactly fills the detector surface area, the radiant flux on the detector (assuming no lens loss) is

$$P_D = P_L = H' \pi r_L^2, \quad (13)$$

where

P_D is the radiant flux incident on the detector,

P_L is the radiant flux incident on the lens,

H' is the flux density on the lens, and

r_L is the lens radius.

Using equation (12),

$$H' = I/d^2 = H. \quad (14)$$

The flux density on the detector is

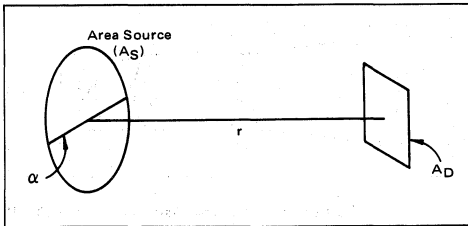

FIGURE 11 – Area Source Geometry

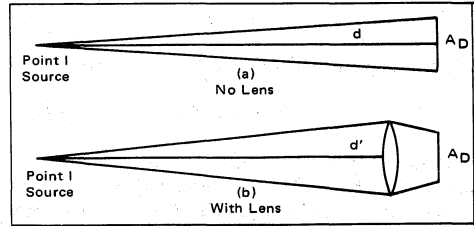

Figure 12 – Use of a Lens to Increase Irradiance on a Detector

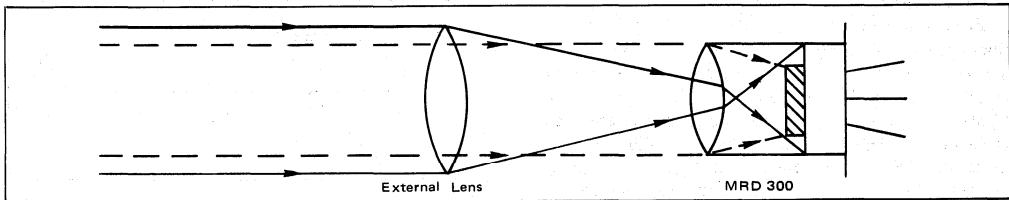

FIGURE 13 – Possible Misalignment Due to Arbitrary Use of External Lens Dotted Rays Indicate Performance Without External Lens

$$H_D = P_D/A_D, \quad (15)$$

where A_D is the detector area, given by

$$A_D = \pi r_d^2 \quad (16)$$

Using (13), (14), and (16) in (15) gives

$$H_D = \frac{I}{d^2} \left(\frac{r_L}{r_d} \right)^2 \quad (17)$$

Now dividing (17) by (11) gives the ratio of irradiance on the detector with a lens to the irradiance without a lens.

$$\frac{H_D}{H} = \frac{I}{d^2} \left(\frac{r_L}{r_d} \right)^2 = \left(\frac{r_L}{r_d} \right)^2 \quad (18)$$

As (18) shows, if the lens radius is greater than the detector radius, the lens provides an increase in incident irradiance on the detector. To account for losses in the lens, the ratio is reduced by about ten percent.

$$R = 0.9 \left(\frac{r_L}{r_d} \right)^2 \quad (19)$$

where R is the gain of the lens system.

It should be pointed out that arbitrary placement of a lens may be more harmful than helpful. That is, a lens system must be carefully planned to be effective.

For example, the MRD300 phototransistor contains a lens which is effective when the input is in the form of parallel rays (as approximated by a uniformly radiating point source). Now, if a lens is introduced in front of the MRD300 as shown in Figure 13, it will provide a non-

parallel ray input to the transistor lens. Thus the net optical circuit will be misaligned. The net irradiance on the phototransistor chip may in fact be less than without the external lens. The circuit of Figure 14 does show an effective system. Lens 1 converges the energy incident on its surface to lens 2 which reconverts this energy into parallel rays. The energy entering the phototransistor lens as parallel rays is the same (neglecting losses) as that entering lens 1. Another way of looking at this is to imagine that the phototransistor surface has been increased to a value equal to the surface area of lens 1.

FIBER OPTICS

Another technique for maximizing the coupling between source and detector is to use a fiber bundle to link the phototransistor to the light source. The operation of fiber optics is based on the principle of total internal reflection.

Figure 15 shows an interface between two materials of different indices of refraction. Assume that the index of refraction, n , of the lower material is greater than that, n' , of the upper material. Point P represents a point source of light radiating uniformly in all directions. Some rays from P will be directed at the material interface.

At the interface, Snell's law requires:

$$n \sin \theta = n' \sin \theta', \quad (20)$$

where

θ is the angle between a ray in the lower material and the normal to the interface,

and

θ' is the angle between a refracted ray and the normal.

Rearranging (20),

$$\sin \theta' = \frac{n}{n'} \sin \theta. \quad (21)$$

By assumption, n/n' is greater than one, so that

$$\sin \theta' > \sin \theta. \quad (22)$$

However, since the maximum value of $\sin \theta'$ is one and occurs when θ' is 90° , θ' will reach 90° before θ does. That is, for some value of θ , defined as the critical angle, θ_C , rays from P do not cross the interface. When $\theta > \theta_C$, the rays are reflected entirely back into the lower material, or total internal reflection occurs.

Figure 16 shows the application of this principle to fiber optics. A glass fiber of refractive index n is clad with a layer of glass of lower refractive index, n' . A ray of light entering the end of the cable will be refracted as shown. If, after refraction, it approaches the glass interface at an angle greater than θ_C , it will be reflected within the fiber. Since the angle of reflection must equal the angle of incidence, the ray will bounce down the fiber and emerge, refracted, at the exit end.

The numerical aperture, NA, of a fiber is defined as the sin of the half angle of acceptance. Application of Snell's law at the interface for θ_C , and again at the fiber end will give

$$NA \equiv \sin \phi = \sqrt{n^2 - n'^2}. \quad (23)$$

For total internal reflection to occur, a light ray must enter the fiber within the half angle ϕ .

Once a light ray is within the fiber, it will suffer some attenuation. For glass fibers, an absorption rate of from five to ten per cent per foot is typical. There is also an entrance and exit loss at the ends of the fiber which typically result in about a thirty per cent loss.

As an example, an illuminance E at the source end of a three-foot fiber bundle would appear at the detector as

$$E_D = 0.7 E e^{-\alpha L} = 0.7 E e^{-(0.1)(3)} = 0.51 E, \quad (24)$$

where E is the illuminance at the source end,

E_D is the illuminance at the detector end,

α is the absorption rate, and

L is the length.

This assumes an absorption loss of ten percent per foot.

TUNGSTEN LAMPS

Tungsten lamps are often used as radiation sources for photodetectors. The radiant energy of these lamps is distributed over a broad band of wavelengths. Since the eye and the phototransistor exhibit different wavelength-dependent response characteristics, the effect of a tungsten lamp will be different for both. The spectral output of a tungsten lamp is very much a function of color temperature.

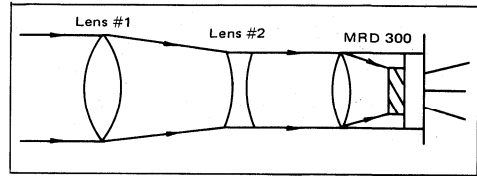

FIGURE 14 — Effective Use of External Optics with the MRD 300

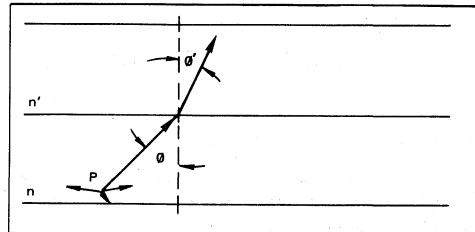

FIGURE 15 — Ray Refraction at an Interface

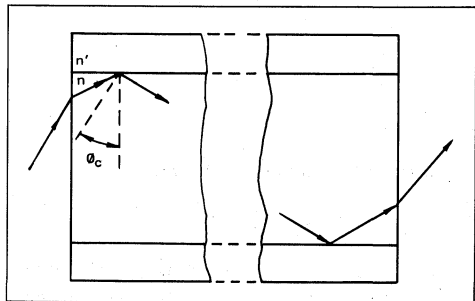

FIGURE 16 — Refraction in an Optical Fiber

Color temperature of a lamp is the temperature required by an ideal blackbody radiator to produce the same visual effect as the lamp. At low color temperatures, a tungsten lamp emits very little visible radiation. However, as color temperature is increased, the response shifts toward the visible spectrum. Figure 17 shows the spectral distribution of tungsten lamps as a function of color temperature. The lamps are operated at constant wattage and the response is normalized to the response at 2800°K . For comparison, the spectral response for both the standard observer and the MRD phototransistor series are also plotted. Graphical integration of the product of the standard observer response and the pertinent source distribution from Figure 17 will provide a solution to equations (2a) and (2b).

Effective Irradiance — Although the sensitivity of a photodetector to an illuminant source is frequently provided, the sensitivity to an irradiant source is more common. Thus, it is advisable to carry out design work in

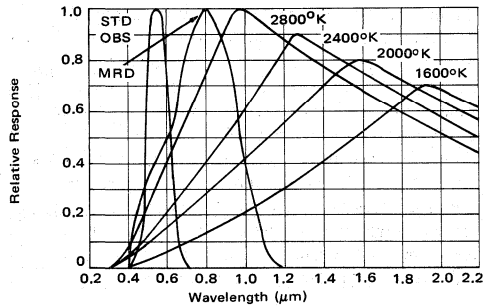

FIGURE 17 – Radiant Spectral Distribution of Tungsten Lamp

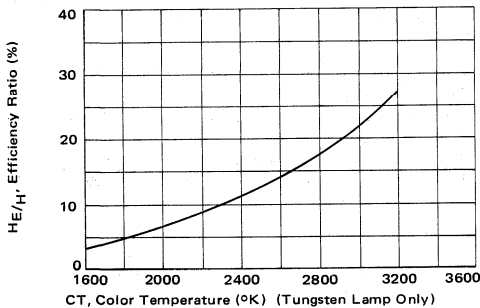

FIGURE 18 – MRD Irradiance Ratio versus Color Temperature

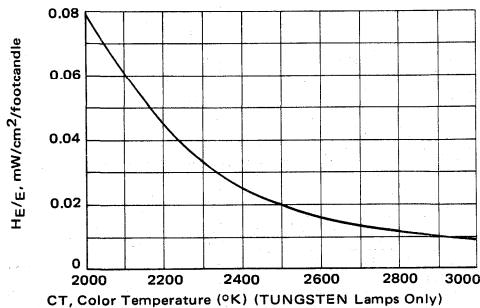

FIGURE 19 – MRD Irradiance/Illuminance Ratio versus Color Temperature

terms of irradiance. However, since the spectral response of a source and a detector are, in general, not the same, a response integration must still be performed. The integral is similar to that for photometric evaluation.

$$P_E = \int P(\lambda) Y(\lambda) d\lambda \quad (25)$$

where

P_E is the effective radiant flux on the detector, $P(\lambda)$ is the spectral distribution of source flux

and

$Y(\lambda)$ is the spectral response of the detector.

Again, such an integration is best evaluated graphically. In terms of flux density, the integral is

$$H_E = \int H(\lambda) Y(\lambda) d\lambda \quad (26)$$

where H_E is the effective flux density (irradiance) on the detector

and $H(\lambda)$ is the absolute flux density distribution of the source on the detector.

Graphical integration of equations (2b) and (26) has been performed for the MRD series of phototransistors for several values of lamp color temperature. The results are given in Figures 18 and 19 in terms of ratios. Figure 18 provides the irradiance ratio, H_E/H versus color temperature. As the curve shows, a tungsten lamp operating at 2600°K is about 14% effective on the MRD series devices. That is, if the broadband irradiance of such a lamp is measured at the detector and found to be 20 mW/cm^2 , the transistor will effectively see

$$H_E = 0.14 (20) = 2.8 \text{ mW/cm}^2 \quad (27)$$

The specifications for the MRD phototransistor series include the correction for effective irradiance. For example, the MRD450 is rated for a typical sensitivity of 0.8 $mA/mW/cm^2$. This specification is made with a tungsten source operating at 2870°K and providing an irradiance at the transistor of 5.0 mW/cm^2 . Note that this will result in a current flow of 4.0 mA .

However, from Figure 18, the effective irradiance is

$$H_E = (5.0)(.185) = 0.925 \text{ mW/cm}^2 \quad (28)$$

By using this value of H_E and the typical sensitivity rating it can be shown that the device sensitivity to a monochromatic irradiance at the MRD450 peak response of 0.8 μm is

$$S = \frac{I_C}{H_E} = \frac{4.0 \text{ mA}}{0.925 \text{ mW/cm}^2} = 4.33 \text{ mA/mW/cm}^2 \quad (29)$$

Now, as shown previously, an irradiance of 20 mW/cm^2 at a color temperature of 2600°K looks like monochromatic irradiance at 0.8 μm of 2.8 mW/cm^2 (Equation 27). Therefore, the resultant current flow is

$$I = S H_E (4.33)(2.8) = 12.2 \text{ mA} \quad (30)$$

An alternate approach is provided by Figure 20. In this figure, the relative response as a function of color temperature has been plotted. As the curve shows, the response is down to 83% at a color temperature of 2600°K. The specified typical response for the MRD450 at 20 mW/cm^2 for a 2870°K tungsten source is 0.9 $mA/mW/cm^2$. The current flow at 2600°K and 20 mW/cm^2 is therefore

$$I = (0.83)(0.9)(20) = 14.9 \text{ mA} \quad (31)$$

This value agrees reasonably well with the result obtained in Equation 30. Similarly, Figure 19 will show that a current flow of 6.67 mA will result from an illuminance of 125 foot candles at a color temperature of 2600°K.

Determination of Color Temperature – It is very likely that a circuit designer will not have the capability to measure color temperature. However, with a voltage measuring capability, a reasonable approximation of color temperature may be obtained. Figure 21 shows the classical variation of lamp current, candlepower and lifetime for a tungsten lamp as a function of applied voltage. Figure 22 shows the variation of color temperature as a function of the ratio

$$\rho = \frac{\text{MSCP}}{\text{WATT}} \quad (32)$$

where

MSCP is the mean spherical candlepower at the lamp operating point and WATT is the lamp IV product at the operating point.

As an example, suppose a type 47 indicator lamp is used as a source for a phototransistor. To extend the lifetime, the lamp is operated at 80% of rated voltage.

| Lamp | Rated Volts | Rated Current | MSCP |
|------|-------------|---------------|-------------|
| 47 | 6.3V | 150 mA | 0.52 approx |

Geometric Considerations – The candlepower ratings on most lamps are obtained from measuring the total lamp output in an integrating sphere and dividing by the unit solid angle. Thus the rating is an average, or mean-spherical-candlepower. However, a tungsten lamp cannot radiate uniformly in all directions, therefore, the candlepower varies with the lamp orientation. Figure 23 shows the radiation pattern for a typical frosted tungsten lamp. As shown, the maximum radiation occurs in the horizontal direction for a base-down or base-up lamp. The circular curve simulates the output of a uniform radiator, and contains the same area as the lamp polar plot. It indicates that the lamp horizontal output is about 1.33

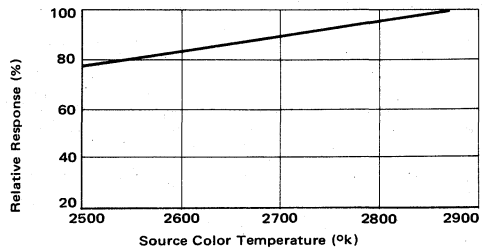

FIGURE 20 – Relative Response of MRD Series versus Color Temperature

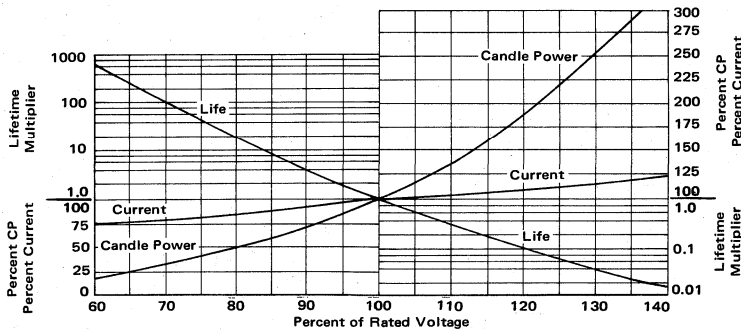

FIGURE 21 – Tungsten Lamp Parameter Variations versus Variations about Rated Voltage

From Figure 21 for 80% rated voltage,
 (Rated Current) (Percent current) = (.15)(0.86) = 0.129 ampere
 (Rated CP) (Percent CP) = (0.5)(0.52) = 0.26 CP
 (Rated Voltage) (Percent Voltage) = (6.3)(0.8) = 5.05 V

$$\text{WATTS} = (5.05)(0.129) = 0.65$$

$$\rho = \frac{0.26}{0.65} = 0.4,$$

From Figure 22, for $\rho = 0.4$,

$$\text{CT} = 2300^\circ\text{K},$$

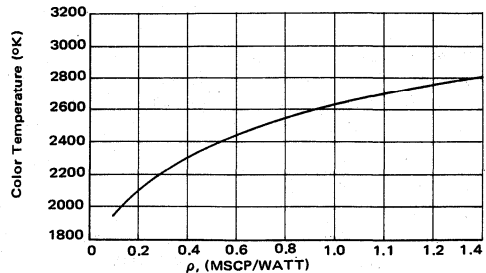

FIGURE 22 – Color Temperature versus Candle Power/Power Ratio



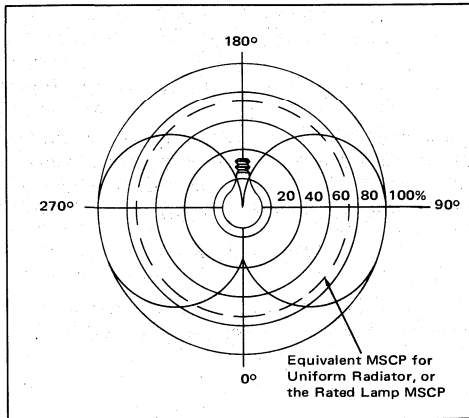

FIGURE 23 – Typical Radiation Pattern for a Frosted Incandescent Lamp

times the rated MSCP, while the vertical output, opposite the base, is 0.48 times the rated MSCP.

The actual polar variation for a lamp will depend on a variety of physical features such as filament shape, size and orientation and the solid angle intercepted by the base with respect to the center of the filament.

If the lamp output is given in horizontal candlepower (HCP), a fairly accurate calculation can be made with regard to illuminance on a receiver.

A third-form of rating is beam candlepower, which is provided for lamps with reflectors.

In all three cases the rating is given in lumens/steradian or candlepower.

SOLID STATE SOURCES

In contrast with the broadband source of radiation of the tungsten lamp, solid state sources provide relatively narrow band energy. The gallium arsenide (GaAs) light-emitting-diode (LED) has spectral characteristics which make it a favorable mate for use with silicon photo-detectors. LED's are available for several wavelengths, as

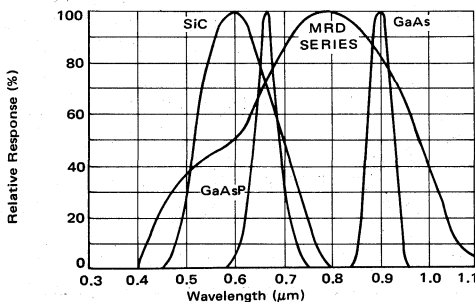

FIGURE 24 – Spectral Characteristics for Several LED's Compared with MRD Series

shown in Figure 24, but as the figure shows, the GaAs diode and the MRD phototransistor series are particularly compatible. Application of Equation (26) to the GaAs response and the MRD series response indicates that the efficiency ratio, H_E/H , is approximately 0.9 or 90%. That is, an irradiance of 4.0 mW/cm² from an LED will appear to the phototransistor as 3.6 mW/cm². This means that a typical GaAs LED is about 3.5 times as effective as a tungsten lamp at 2870°K. Therefore, the typical sensitivity for the MRD450 when used with a GaAs LED is approximately

$$S = (0.8)(3.5) = 2.8 \text{ mA/mW/cm}^2. \quad (33)$$

An additional factor to be considered in using LED's is the polar response. The presence of a lens in the diode package will confine the solid angle of radiation. If the solid angle is θ , the resultant irradiance on a target located at a distance d is

$$H = \frac{4P}{\pi\theta^2 d^2} \text{ watts/cm}^2, \quad (34)$$

where

P is the total output power of the LED in watts

θ is the beam angle

d is the distance between the LED and the detector in cm.

LOW FREQUENCY AND STEADY STATE APPLICATIONS

Light Operated Relay – Figure 25 shows a circuit in which presence of light causes a relay to operate. The relay used in this circuit draws about 5 mA when Q2 is in saturation. Since h_{FE} (min) for the MPS3394 is 55 at a collector current of 2mA, a base current of 0.5 mA is sufficient to ensure saturation. Phototransistor Q1 provides the necessary base drive. If the MRD300 is used, the minimum illumination sensitivity is 4 μ A/footcandle, therefore,

$$E = \frac{I_C}{S_{ICEO}} = \frac{0.5 \text{ mA}}{4 \times 10^{-3} \text{ mA/footcandle}} \quad (35)$$

$$E = 125 \text{ footcandles}$$

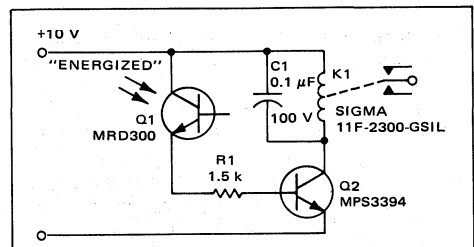

FIGURE 25 – Light-Operated Relay

This light level can be supplied by a flashlight or other equivalent light source.

The equivalent irradiance is obviously that value of irradiance which will cause the same current flow. Assume the light source is a flashlight using a PR2 lamp. The ratings for this lamp are

| Lamp | Rated Volts | Rated Current | MSCP |
|------|-------------|---------------|------|
| PR2 | 2.38 | 0.50 A | 0.80 |

If the flashlight has new batteries the lamp voltage is

$$V_L = 2(1.55) = 3.1 \text{ volts} \quad (36)$$

This means that the lamp is operated at 130 per cent of rated voltage. From Figure 21 for 130% rated voltage,

$$\text{(Rated Current) (Percent Current)} = (0.5)(1.15) = 0.575 \text{ ampere}$$

$$\text{(Rated CP) (Percent CP)} = (0.80)(2.5) = 2 \text{ CP}$$

$$\text{(Rated Voltage) (Percent Voltage)} = (2.38)(1.3) = 3.1 \text{ volts.}$$

Therefore, the MSCP/watt rating is 1.12. From Figure 22, the color temperature is 2720°K.

Now, from Figure 20, the response at a color temperature of 2720°K is down to 90% of its reference value. At the reference temperature, the minimum SRCEO for the MRD300 is 0.8 mA/mW/cm², so at 2720°K it is

$$SR_{CEO}(\text{MIN}) = (0.9)(0.8) = 0.72 \text{ mA/mW/cm}^2 \quad (37)$$

and

$$H_E = \frac{I_C}{SR_{CEO}} = \frac{0.5}{0.72} = 0.65 \text{ mW/cm}^2 \quad (38)$$

However, sensitivity is a function of irradiance, and at 0.695 mW/cm² it has a minimum value (at 2720°K) of about 0.45 mA/mW/cm², therefore

$$H_E = \frac{0.5}{0.45} = 1.11 \text{ mW/cm}^2 \quad (39)$$

Again, we note that at an irradiance of 1.11 mW/cm², the minimum SRCEO is about 0.54 mA/mW/cm². Several applications of the above process eventually result in a convergent answer of

$$H_E \approx 1.0 \text{ mW/cm}^2 \quad (40)$$

Now, from the MRD450 data sheet, SRCEO (min) at an irradiance of 1.0 mW/cm² and color temperature of 2720°K is

$$SR_{CEO} = (0.15)(0.9) = 0.135 \text{ mA/mW/cm}^2 \quad (41)$$

At 1.0 mW/cm², we can expect a minimum I_C of 0.135 mA. This is below the design requirement of 0.5 mA. By looking at the product of SRCEO (min) and H on the data sheet curve, the minimum H for 0.5 mA for using the MRD450 can now be calculated.

$$\frac{H}{H_E} = \frac{3.0}{1.0} = \frac{I(\text{MRD450})}{I(\text{MRD300})} = \frac{I(\text{MRD450})}{125} \quad (42)$$

or

$$I(\text{MRD450}) = 375 \text{ footcandles} \quad (43)$$

This value is pretty high for a two D-cell flashlight, but the circuit should perform properly since about 200 footcandles can be expected from a flashlight, giving a resultant current flow of approximately

$$I = \frac{220}{275} (0.5 \text{ mA}) = 0.293 \text{ mA} \quad (44)$$

This will be the base current of Q2, and since the relay requires 5 mA, the minimum hFE required for Q2 is

$$hFE(Q2) = \frac{5}{0.293} = 17. \quad (45)$$

This is well below the hFE (min) specification for the MPS3394 (55) so proper circuit performance can be expected.

A variation of the above circuit is shown in Figure 26. In this circuit, the presence of light deenergizes the relay. The same light levels are applicable. The two relay circuits can be used for a variety of applications such as automatic door activators, object or process counters, and intrusion alarms. Figure 27, for example, shows the circuit of Figure 26 used to activate an SCR in an alarm system. The presence of light keeps the relay deenergized, thus denying trigger current to the SCR gate. When the light is interrupted, the relay energizes, providing the SCR with trigger current. The SCR latches ON, so only a momentary interruption of light is sufficient to cause the alarm to ring continuously. S1 is a momentary contact switch for resetting the system.

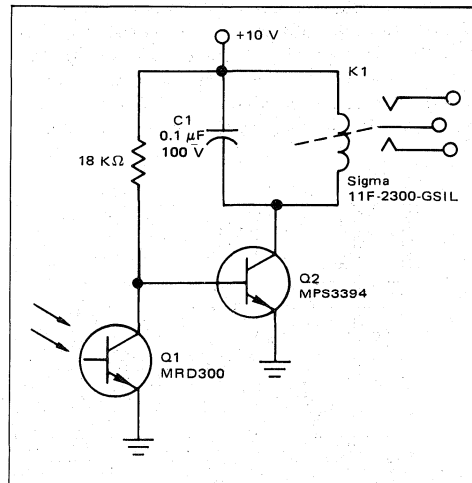

FIGURE 26 — Light De-energized Relay

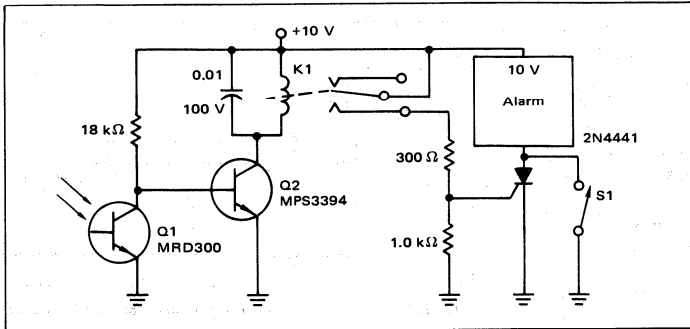

FIGURE 27 – Light-Relay Operated SCR Alarm Circuit

If the SCR has a sensitive gate, the relay can be eliminated as shown in Figure 28. The phototransistor holds the gate low as long as light is present, but pulls the gate up to triggering level when the light is interrupted. Again, a reset switch appears across the SCR.

Voltage Regulator – The light output of an incandescent lamp is very dependent on the RMS voltage applied to it. Since the phototransistor is sensitive to light changes, it can be used to monitor the light output of a lamp, and in a closed-loop system to control the lamp voltage. Such a regulator is particularly useful in a projection system where it is desired to maintain a constant brightness level despite line voltage variations.

Figure 29 shows a voltage regulator for a projection lamp. The RMS voltage on the lamp is set by the firing angle of the SCR. This firing angle in turn is set by the unijunction timing circuit. Transistors Q1 and Q2 form a constant-current source for charging timing capacitor C.

The magnitude of the charging current, the capacitance, C, and the position of R6 set the firing time of the UJT oscillator which in turn sets the firing angle of the SCR. Regulation is accomplished by phototransistor Q3. The brightness of the lamp sets the current level in Q3, which diverts current from the timing capacitor. Potentiometer R6 is set for the desired brightness level.

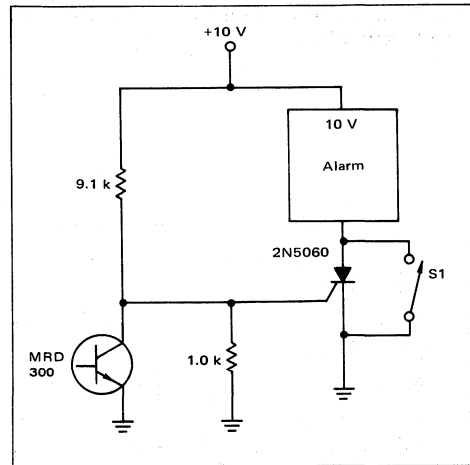

FIGURE 28 – Light Operated SCR Alarm Using Sensitive-Gate SCR

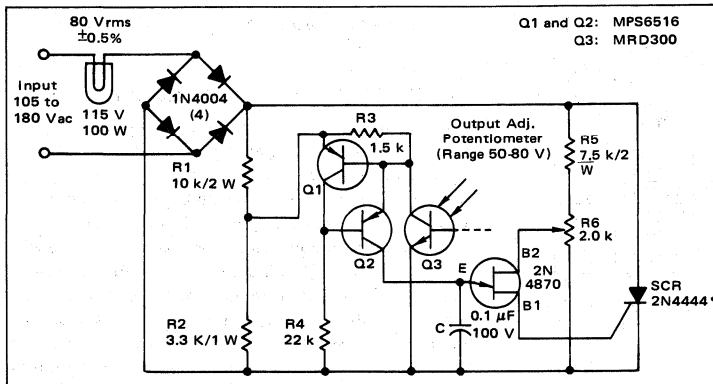

FIGURE 29 – Circuit Diagram of Voltage Regulator for Projection Lamp.

*2N4444 to be used with a heat sink.

If the line voltage rises, the lamp tends to become brighter, causing an increase in the current of Q3. This causes the unijunction to fire later in the cycle, thus reducing the conduction time of the SCR. Since the lamp RMS voltage depends on the conduction angle of the SCR, the increase in line voltage is compensated for by a decrease in conduction angle, maintaining a constant lamp voltage.

Because the projection lamp is so bright, it will saturate the phototransistor if it is directly coupled to it. Either of two coupling techniques are satisfactory. The first is to attenuate the light to the phototransistor with a translucent material with a small iris. The degree of attenuation or translucency must be experimentally determined for the particular projection lamp used.

The second coupling technique is to couple the lamp and phototransistor by a reflected path. The type of reflective surface and path length will again depend on the particular lamp being used.

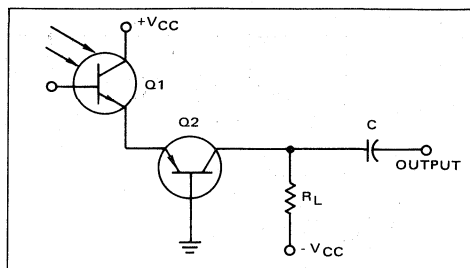

FIGURE 32 — Improved Speed Configuration for Phototransistor

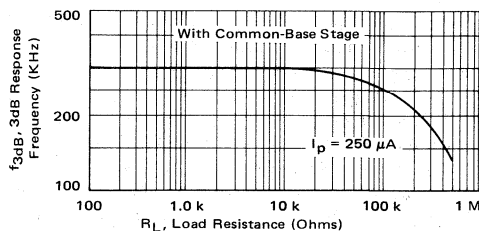

FIGURE 33 — 3dB Frequency Response for Speed-up Circuit

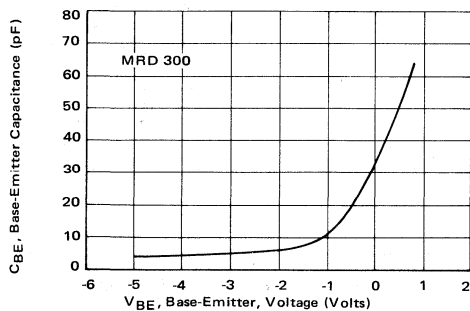

FIGURE 30 — MRD300 Base-Emitter Junction Capacitance versus Voltage

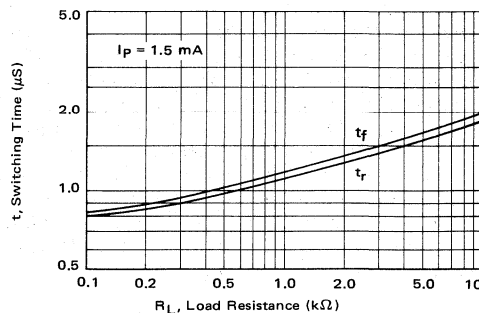

FIGURE 34 — Switching Times with Speed-up Circuit

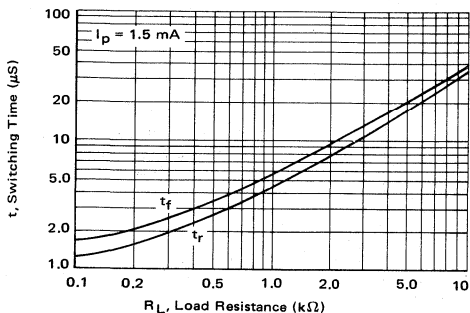

FIGURE 31 — MRD300 Switching Times versus Load Resistance

HIGH FREQUENCY DESIGN APPROACHES

It was shown in Figure 7 that the frequency response of the MRD phototransistor series is quite dependent on the load. Depending on the load value and the frequency of operation, the device can be modeled simply as in Figure 6, or else in the modified hybrid-pi form of Figure 3.

While the hybrid-pi model may be useful for detailed analytical work, it does not offer much for the case of simplified design. It is much easier to consider the transistor simply as a current source with a first-order transient response. With the addition of switching characteristics to the device information already available, most design problems can be solved with a minimum of effort.

Switching Characteristics – When the phototransistor changes state from OFF to ON, a significant time delay is associated with the $r_{be} C_{be}$ time constant. As shown in Figure 30, the capacitance of the emitter-base junction is appreciable. Since the device photocurrent is $g_m v_{be}$ (from Figure 3), the load current can change state only as fast as v_{be} can change. Also, v_{be} can change only as fast as C_{be} can charge and discharge through the load resistance. Figure 31 shows the variations in rise and fall time with load resistance. This measurement was made using a GaAs light emitting diode for the light source. The LED output power and the separation distance between the LED and the phototransistor were adjusted for an ON phototransistor current of 1.5 mA. The rise time was also measured for a short-circuited load and found to be about 700 ns.

The major difficulty encountered in high-frequency applications is the load-dependent frequency response. Since the phototransistor is a current source, it is desirable to use a large load resistance to develop maximum output voltage. However, large load resistances limit the useful frequency range. This seems to present the designer with a tradeoff between voltage and speed. However, there is a technique available to eliminate the need for such a tradeoff.

Figure 32 shows a circuit designed to optimize both speed and output voltage. The common-base stage Q2 offers a low-impedance load to the phototransistor, thus maximizing response speed. Since Q2 has near-unity current gain, the load current in R_L is approximately equal to the phototransistor current. Thus the impedance transformation provided by Q2 results in a relatively load-independent frequency response.

The effect of Q2 is shown in Figures 33 and 34. In Figure 33, the 3-dB frequency response as a function of load is shown. Comparing this with Figure 7, the effect of Q2 is quite evident. Comparison of Figures 31 and 34 also demonstrates the effect of Q2.

Remote Strobe Flash Slave Adapter – At times when using an electronic strobe flash, it is desirable to use a remote, or “slave” flash synchronized with the master. The circuit in Figure 35 provides the drive needed to trigger a slave unit, and eliminates the necessity for

synchronizing wires between the two flash units.

The MRD300 phototransistor used in this circuit is cut off in a VCER mode due to the relatively low dc resistance of rf choke L1 even under high ambient light conditions. When a fast-rising pulse of light strikes the base region of this device, however, L1 acts as a very high impedance to the ramp and the transistor is biased into conduction by the incoming pulse of light.

When the MRD300 conducts, a signal is applied to the gate of SCR Q2. This triggers Q2, which acts as a solid-state relay and turns on the attached strobe flash unit.

In tests this unit was unaffected by ambient light conditions. It fired up to approximately 20 feet from strobe-light flashes using only the lens of the MRD300 for light pickup.

CONCLUSION

The phototransistor provides the circuit or system designer with a unique component for use in dc and linear or digital time-varying applications. Use of a phototransistor yields extremely high electrical and mechanical isolation. The proper design of an electro-optical system requires a knowledge of both the radiation source characteristics and the phototransistor characteristics. This knowledge, coupled with an adequately defined distance and geometric relationship, enables the designer to properly predict the performance of his designs.

REFERENCES

1. Motorola Application Note AN-440, *Theory and Characteristics of Phototransistors*.
2. Francis W. Sears, *Optics*, Addison-Wesley Publishing Company, Inc., 1948.
3. *IES Lighting Handbook*, 3rd Edition, Illuminating Engineering Society, 1959.

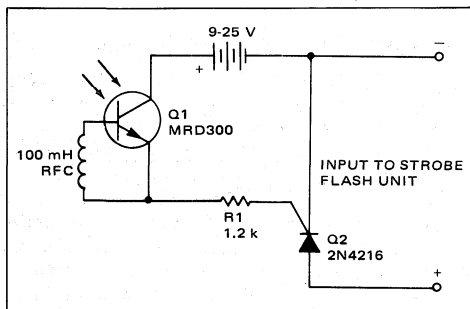

FIGURE 35 – Strobe Flash Slave Adapter

ISOLATION TECHNIQUES USING OPTICAL COUPLERS

Prepared by
Francis Christian

INTRODUCTION

The optical coupler is a new device that offers the design engineer new freedoms in designing circuits and systems. Problems such as ground loop isolation, common mode noise rejection, power supply transformations, and many more problems can be solved or simplified with the use of an optical coupler.

Operation is based on the principle of detecting emitted light. The input to the coupler is connected to a light emitter and the output is a photodetector, the two elements being separated by a transparent insulator and housed in a light-excluding package. There are many types of optical couplers; for example, the light source could be an incandescent lamp or a light emitting diode (LED). Also, the detector could be photovoltaic cell, photoconductive cell, photodiode, phototransistor, or a light-sensitive SCR. By various combinations of emitters and detectors, a number of different types of optical couplers could be assembled.

Once an emitter and detector have been assembled as a coupler, the optical portion is permanently established so that device use is only electronic in nature. This eliminates the need for the circuit designer to have knowledge of optics. However, for effective application, he must know something of the electrical characteristics, capabilities, and limitations, of the emitter and detector.

COUPLER CHARACTERISTICS

The 4N25 is an optical coupler consisting of a gallium arsenide (GaAs) LED and a silicon phototransistor. (For more information on LEDs and phototransistors, see References 1 and 2).

The coupler's characteristics are given in the following sequence: LED characteristics, phototransistor characteristics, coupled characteristics, and switching characteristics. Table 1 shows all four for the 4N25 series.

INPUT

For most applications the basic LED parameters I_F and V_F are all that are needed to define the input. Figure 1 shows these forward characteristics, providing the necessary information to design the LED drive circuit. Most circuit applications will require a current limiting resistor in series with the LED input. The circuit in Figure 2 is a typical drive circuit.

The current limiting resistor can be calculated from the following equation:

$$R = \frac{V_{IN} - V_F}{I_F}$$

where V_F = diode forward voltage
 I_F = diode forward current

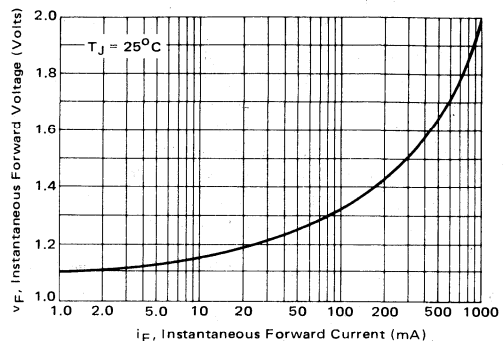

FIGURE 1 — Input Diode Forward Characteristic

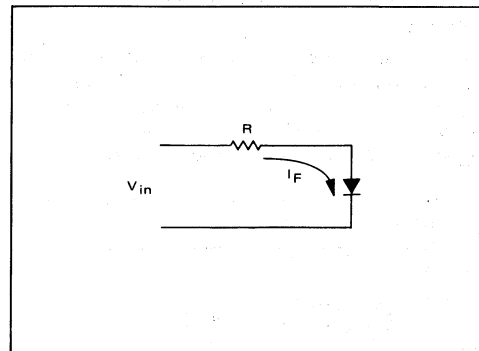

FIGURE 2 — Simple Drive Circuit For An LED

AN571A

TABLE I

LED CHARACTERISTICS ($T_A = 25^\circ\text{C}$ unless otherwise noted)

| Characteristic | Symbol | Min | Typ | Max | Unit |
|--|--------|-----|------|-----|---------------|
| *Reverse Leakage Current ($V_R = 3.0\text{ V}$, $R_L = 1.0\text{ M ohms}$) | I_R | — | 0.05 | 100 | μA |
| *Forward Voltage ($I_F = 50\text{ mA}$) | V_F | — | 1.2 | 1.5 | Volts |
| Capacitance ($V_R = 0\text{ V}$, $f = 1.0\text{ MHz}$) | C | — | 150 | — | pF |

PHOTOTRANSISTOR CHARACTERISTICS ($T_A = 25^\circ\text{C}$ and $I_F = 0$ unless otherwise noted)

| Characteristic | Symbol | Min | Typ | Max | Unit |
|--|------------|-----|-----|-----|-------|
| *Collector-Emitter Dark Current ($V_{CE} = 10\text{ V}$, Base Open) | I_{CEO} | — | 3.5 | 50 | nA |
| *Collector-Base Dark Current ($V_{CB} = 10\text{ V}$, Emitter Open) | I_{CBO} | — | — | 20 | nA |
| *Collector-Base Breakdown Voltage ($I_C = 100\ \mu\text{A}$, $I_E = 0$) | $V(BR)CBO$ | 70 | — | — | Volts |
| *Collector-Emitter Breakdown Voltage ($I_C = 1.0\text{ mA}$, $I_B = 0$) | $V(BR)CEO$ | 30 | — | — | Volts |
| *Emitter-Collector Breakdown Voltage ($I_E = 100\ \mu\text{A}$, $I_B = 0$) | $V(BR)ECO$ | 7.0 | — | — | Volts |
| DC Current Gain ($V_{CE} = 5.0\text{ V}$, $I_C = 500\ \mu\text{A}$) | h_{FE} | — | 250 | — | — |

COUPLED CHARACTERISTICS ($T_A = 25^\circ\text{C}$ unless otherwise noted)

| Characteristic | Symbol | Min | Typ | Max | Unit |
|--|---------------|---------------------|------------|-----|-------|
| *Collector Output Current (1) ($V_{CE} = 10\text{ V}$, $I_F = 10\text{ mA}$, $I_B = 0$) | I_C | 2.0 1.0 | 5.0 3.0 | — | mA |
| *Isolation Voltage (2) | V_{ISO} | 2500 1500 500 | — | — | Volts |
| Isolation Resistance (2) ($V = 500\text{ V}$) | — | — | 10^{11} | — | Ohms |
| *Collector-Emitter Saturation ($I_C = 2.0\text{ mA}$, $I_F = 50\text{ mA}$) | $V_{CE(sat)}$ | — | 0.2 | 0.5 | Volts |
| Isolation Capacitance (2) ($V = 0$, $f = 1.0\text{ MHz}$) | — | — | 1.3 | — | pF |
| Bandwidth (3) ($I_C = 2.0\text{ mA}$, $R_L = 100\text{ ohms}$, Figure 11) | — | — | 300 | — | kHz |

SWITCHING CHARACTERISTICS

| Delay Time | Symbol | Min | Typ | Max | Unit |
|---|--------|-----------|------|-----|---------------|
| ($I_C = 10\text{ mA}$, $V_{CC} = 10\text{ V}$) | t_d | 4N25,4N26 | 0.07 | — | μs |
| | | 4N27,4N28 | 0.10 | — | μs |
| Rise Time Figures 6 and 8 | t_r | 4N25,4N26 | 0.8 | — | μs |
| | | 4N27,4N28 | 2.0 | — | μs |
| Storage Time ($I_C = 10\text{ mA}$, $V_{CC} = 10\text{ V}$) | t_s | 4N25,4N26 | 4.0 | — | μs |
| | | 4N27,4N28 | 2.0 | — | μs |
| Fall Time Figures 7 and 8 | t_f | 4N25,4N26 | 7.0 | — | μs |
| | | 4N27,4N28 | 3.0 | — | μs |

* Indicates JEDEC Registered Data. (1) Pulse Test: Pulse Width = 300 μs , Duty Cycle $\leq 2.0\%$
 (2) For this test LED pins 1 and 2 are common and Photo Transistor pins 4, 5 and 6 are common.
 (3) I_F adjusted to yield $I_C = 2.0\text{ mA}$ and $t_c = 2.0\text{ mA p-p}$ at 10 kHz.

OUTPUT

The output of the coupler is the phototransistor. The basic parameters of interest are the collector current I_C and collector emitter voltage, V_{CE} . Figure 3 is a curve of $V_{CE(sat)}$ versus I_C for two different drive levels.

COUPLING

To fully characterize the coupler, a new parameter, the dc current transfer ratio or coupling efficiency (η) must be defined. This is the ratio of the transistor collector current to diode current I_C/I_F . Figures 4A and 4B show the typical dc current transfer functions for the couplers at $V_{CE} = 10$ volts. Note that η varies with I_F and V_{CE} .

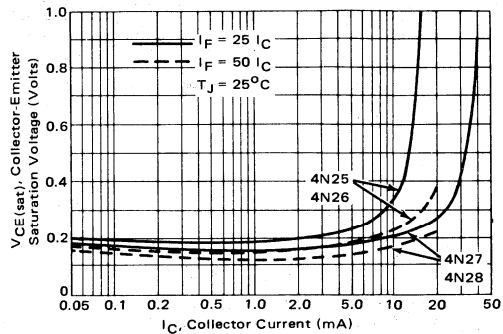

FIGURE 3 — Collector Saturation Voltage

Once the required output collector current I_C is known, the input diode current can be calculated by

$$I_F = I_C / \eta,$$

where I_F is the forward diode current
 I_C is the collector current
 η is the coupling efficiency or transfer ratio.

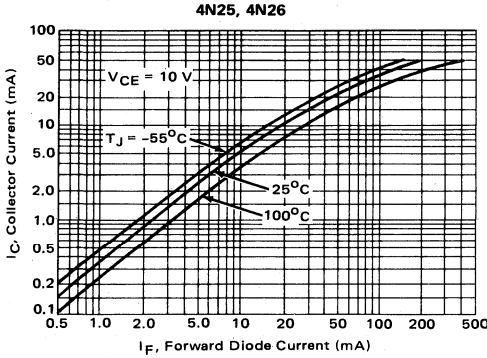

FIGURE 4A - DC Current Transfer Ratio

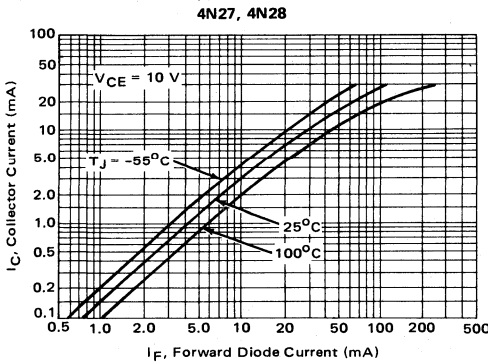

FIGURE 4B - DC Current Transfer Ratio

RESPONSE TIME

The switching times for the couplers are shown in Figures 5A and 5B. The speed is fairly slow compared to switching transistors, but is typical of phototransistors because of the large base-collector area. The switching time or bandwidth of the coupler is a function of the load resistor R_L because of the $R_L C_Q$ time constant where C_Q is the parallel combination of the device and load capacitances. Figure 6 is a curve of frequency response versus R_L .

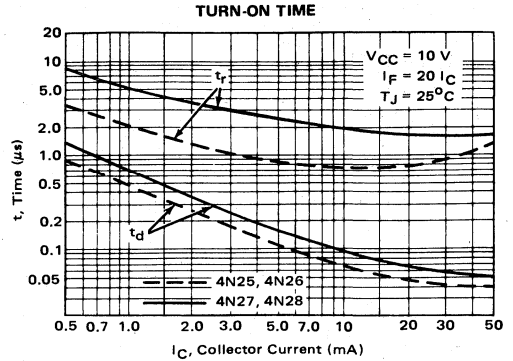

FIGURE 5A - Switching Times

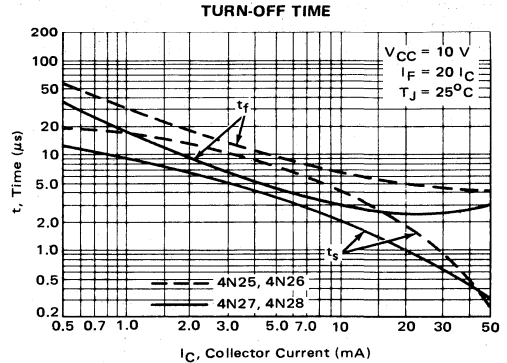

FIGURE 5B - Switching Times

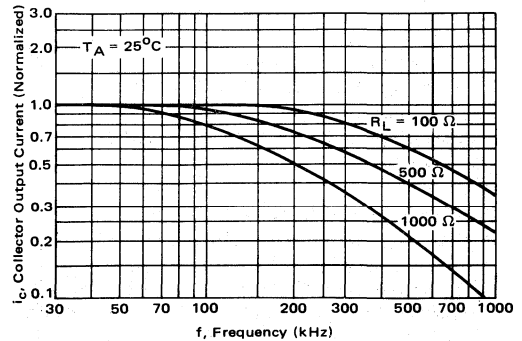

FIGURE 6 - Frequency Response

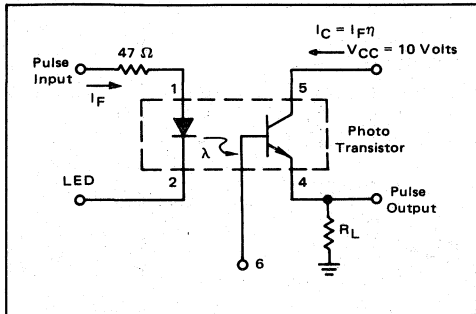

FIGURE 7 – Pulse Mode Circuit

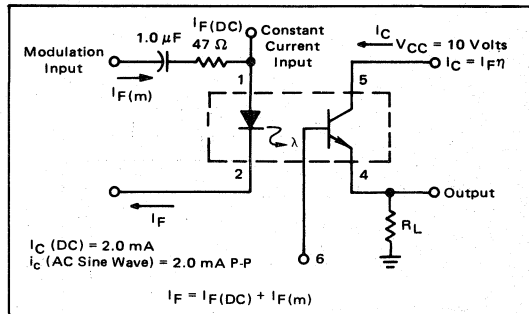

FIGURE 8 – Linear Mode Circuit

OPERATING MODE

The two basic modes of operation are pulsed and linear. In the pulsed mode of operation, the LED will be switched on or off. The output will also be pulses either in phase or 180° out of phase with the input depending on where the output is taken. The output will be 180° out of phase if the collector is used and in phase if the emitter is used for the output.

time for a diode-transistor coupler is in the order of 2 to 5 μs, where the diode-diode coupler is 50 to 100 ns. The one disadvantage with the diode-diode coupler is that the output current is much lower than the diode-transistor coupler. This is because the base current is being used as signal current and the β multiplication of the transistor is omitted. Figure 10 is a graph of IB versus IF using the coupler in the diode-diode mode.

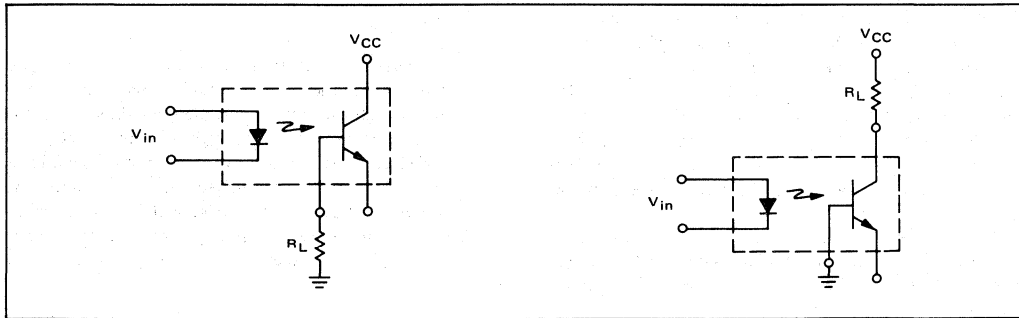

FIGURE 9 – Circuit Connections for Using the 4N26 As a Diode-Diode Coupler

In the linear mode of operation, the input is biased at a dc operating point and then the input is changed about this dc point. The output signal will have an ac and dc component in the signal.

Figures 7 and 8 show typical circuits for the two modes of operation.

THE 4N26 AS A DIODE-DIODE COUPLER

The 4N26 which is a diode-transistor coupler, can be used as a diode-diode coupler. To do this the output is taken between the collector and base instead of the collector and emitter. The circuits in Figure 9 show the connections to use the coupler in the diode-diode mode.

The advantage of using the 4N26 as a diode-diode coupler is increased speed. For example, the pulse rise

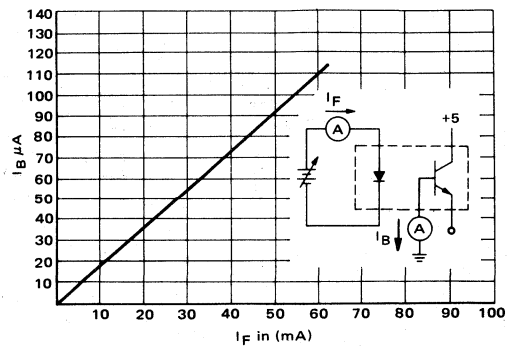

FIGURE 10 – IB versus IF Curve for Using the 4N26 As a Diode-Diode Coupler

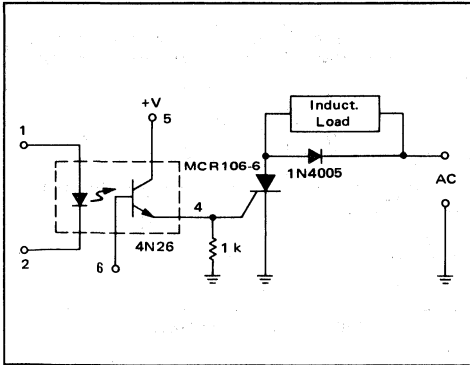

FIGURE 11 – Coupler-Driven SCR

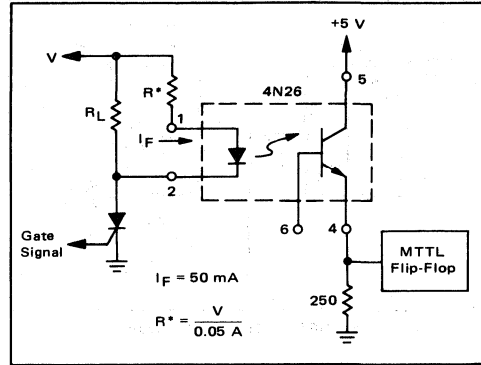

FIGURE 12 – Opto Coupler In A Load To Logic Translation

APPLICATIONS

The following circuits are presented to give the designer ideas of how the 4N26 can be used. The circuits have been bread-boarded and tested, but the values of the circuit components have not been selected for optimum performance over all temperatures.

Figure 11 shows a coupler driving a silicon controlled rectifier (SCR). The SCR is used to control an inductive load, and the SCR is driven by a coupler. The SCR used is a sensitive gate device that requires only 1 mA of gate current and the coupler has a minimum current transfer ratio of 0.2 so the input current to the coupler, I_F , need only be 5 mA. The 1 k resistor connected to the gate of the SCR is used to hold off the SCR. The 1N4005 diode is used to suppress the self-induced voltage when the SCR turns off.

Figure 12 is a circuit that couples a high voltage load to a low voltage logic circuit. To insure that the voltage to the MTTL flip-flop exceeds the logic-one level, the coupler

output current must be at least 10 mA. To guarantee 10 mA of output current, the input current to the LED must be 50 mA. The current limiting resistor R can be calculated from the equation $R = \frac{V - V_F}{0.05}$. If the power supply voltage, V, is much greater than V_F , the equation for R reduces to $R = \frac{V}{0.05}$.

The circuit of Figure 13 shows a coupler driving an operational amplifier. In this application an ac signal is passed through the coupler and then amplified by the op amp. To pass an ac signal through the coupler with minimum distortion, it is necessary to bias the LED with a dc current. The ac signal is summed with the dc current so the output voltage of the coupler will have an ac and a dc component. Since the op amp is capacitively coupled to the coupler, only the ac signal will appear at the output.

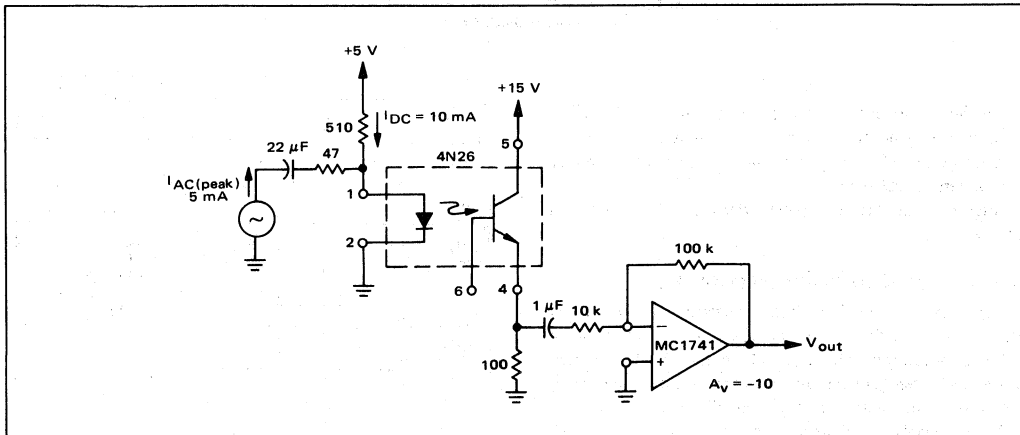

FIGURE 13 – Coupling An AC Signal to an Operational Amplifier

AN571A

The circuit of Figure 14 shows the 4N26 being used as a diode-diode coupler, the output being taken from the collector-base diode. In this mode of operation, the emitter is left open, the load resistor is connected between the base and ground, and the collector is tied to the positive voltage supply. Using the coupler in this way reduces the switching time from 2 to 3 μ s to 100 ns.

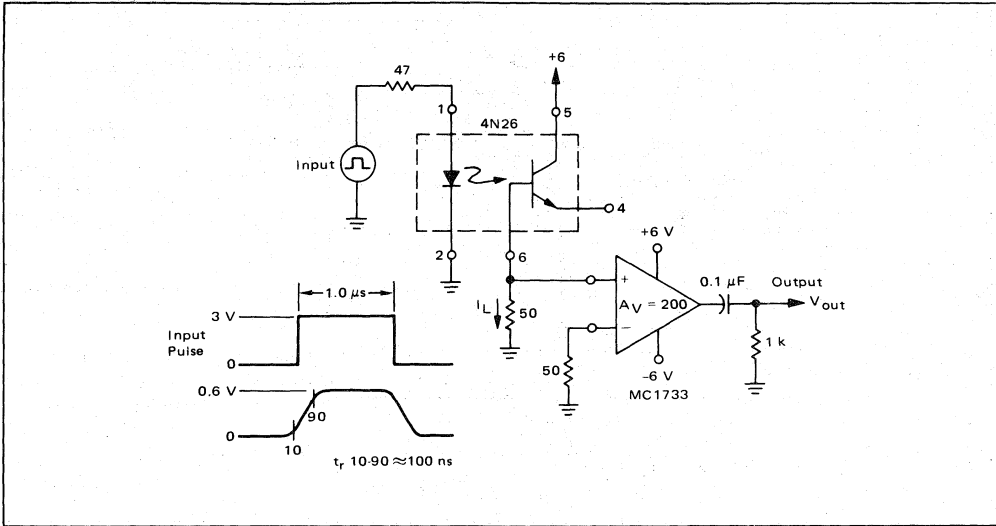

FIGURE 14 – Using the 4N26 as a Diode-Diode Coupler

The circuit of Figure 15 is a standard two-transistor one-shot, with one transistor being the output transistor of the coupler. The trigger to the one-shot is the LED input to the coupler. A pulse of 3 μ s in duration and 15 mA will trigger the circuit. The output pulse width (PW_O) is equal to 0.7 RC + PW_I + 6 μ s where PW_I is the input pulse width and 6 μ s is the turn-off delay of the coupler. The amplitude of the output pulse is a function of the power supply voltage of the output side and independent of the input.

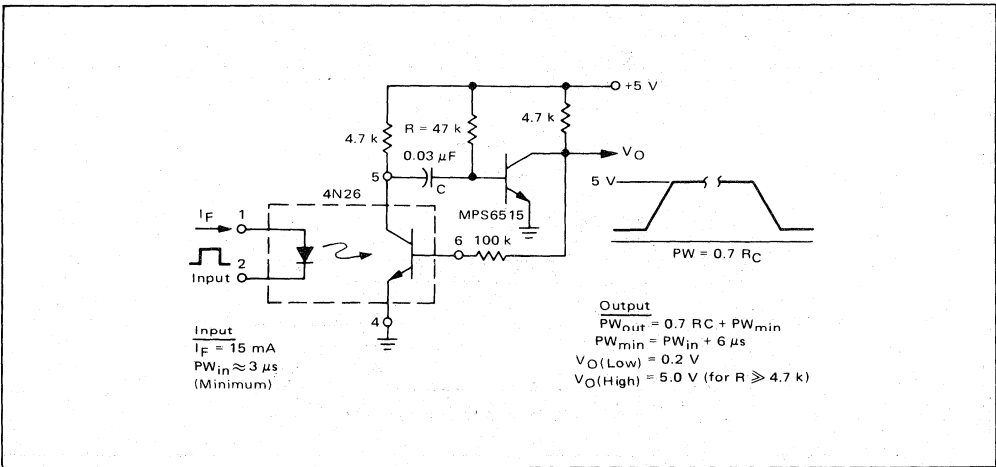

FIGURE 15 – Pulse Stretcher

AN571A

The circuit of Figure 16 is basically a Schmitt trigger. One of the Schmitt trigger transistors is the output transistor of a coupler. The input to the Schmitt trigger is the LED of the coupler. When the base voltage of the coupler's transistor exceeds $V_e + V_{be}$ the output transistor of

the coupler will switch on. This will cause Q2 to conduct and the output will be in a high state. When the input to the LED is removed, the coupler's output transistor will shut off and the output voltage will be in a low state. Because of the high impedance in the base of the coupler

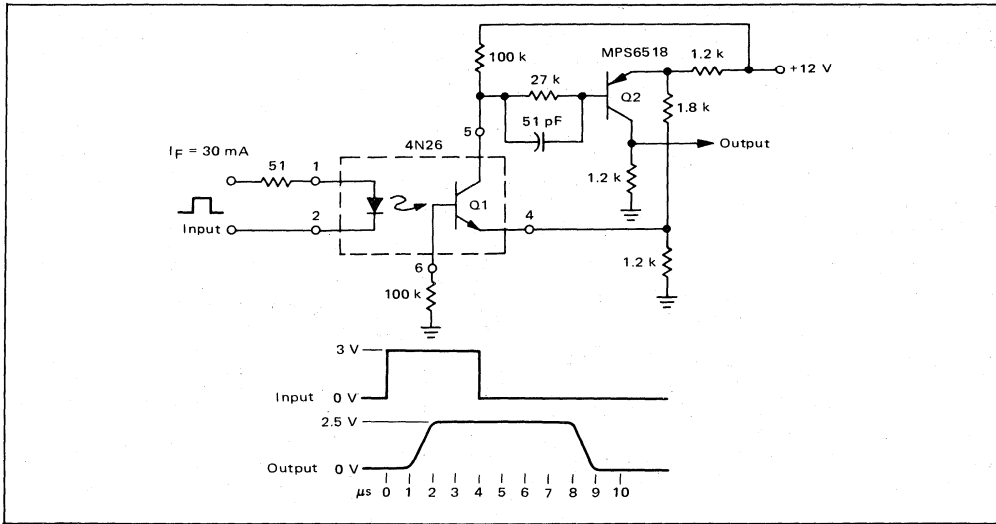

FIGURE 16 – Optically Coupled Schmitt Trigger

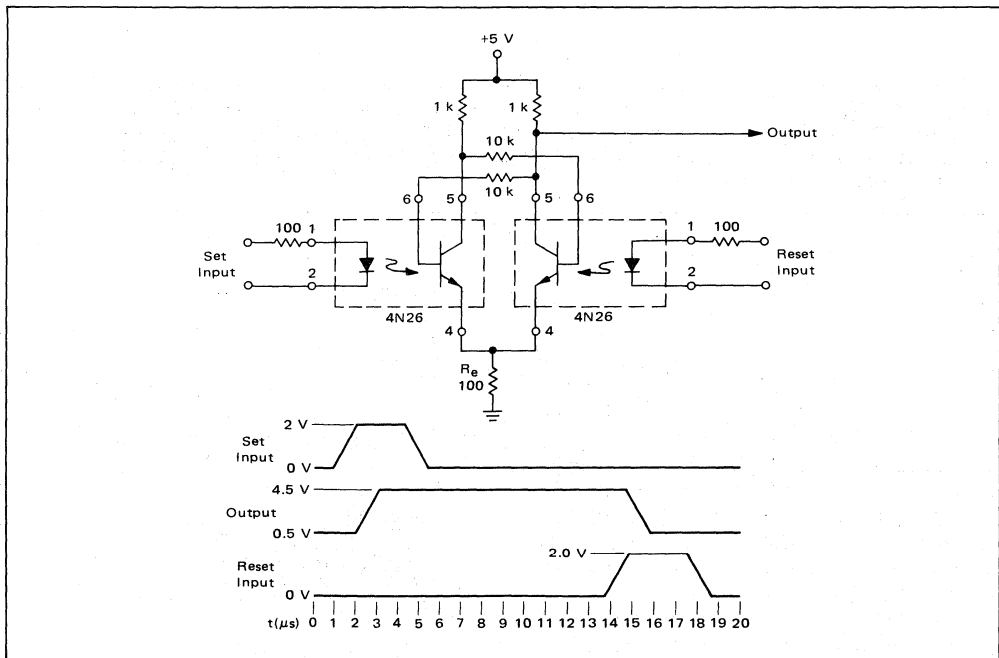

FIGURE 17 – Optically Coupled R-S Flip-Flop

APPLICATIONS OF THE MOC3011 TRIAC DRIVER

Prepared by:
Pat O'Neil

DESCRIPTIONS OF THE MOC3011

Construction

The MOC3011 consists of a gallium arsenide infrared LED optically exciting a silicon detector chip, which is especially designed to drive triacs controlling loads on the 115 Vac power line. The detector chip is a complex device which functions in much the same manner as a small triac, generating the signals necessary to drive the gate of a larger triac. The MOC3011 allows a low power exciting signal to drive a high power load with a very small number of components, and at the same time provides practically complete isolation of the driving circuitry from the power line.

The construction of the MOC3011 follows the same highly successful coupler technology used in Motorola's broad line of plastic couplers (Figure 1). The dual lead

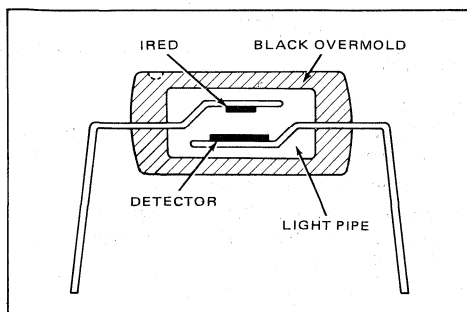

FIGURE 1 — Motorola Double-Molded Coupler Package

frame with an epoxy undermold provides a stable dielectric capable of sustaining 7.5 kV between the input and output sides of the device. The detector chip is passivated with silicon nitride and uses Motorola's annular ring to maintain stable breakdown parameters.

Basic Electrical Description

The GaAs LED has nominal 1.3 V forward drop at 10 mA and a reverse breakdown voltage greater than 3 V. The maximum current to be passed through the LED is 50 mA.

The detector has a minimum blocking voltage of 250 Vdc in either direction in the off state. In the on state, the detector will pass 100 mA in either direction with less than 3 V drop across the device. Once triggered into the on (conducting) state, the detector will remain there until the current drops below the holding current (typically 100 μ A) at which time the detector reverts to the off (non-conducting) state. The detector may be triggered into the on state by exceeding the forward blocking voltage, by voltage ramps across the detector at rates exceeding the static dv/dt rating, or by photons from the LED. The LED is guaranteed by the specifications to trigger the detector into the on state when 10 mA or more is passed through the LED. A similar device, the MOC3010, has exactly the same characteristics except it requires 15 mA to trigger.

Since the MOC3011 looks essentially like a small optically triggered triac, we have chosen to represent it as shown on Figure 2.

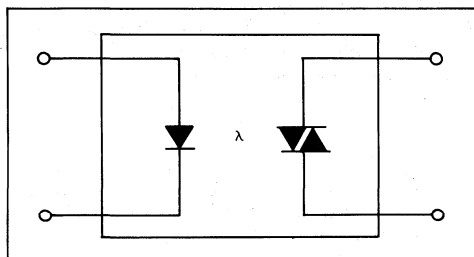

FIGURE 2 — Schematic Representation of MOC3011 and MOC3010

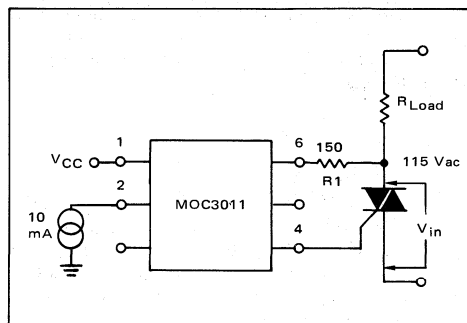

FIGURE 3 — Simple Triac Gating Circuit

USING THE MOC3011 AS A TRIAC DRIVER

Triac Driving Requirements

Figure 3 shows a simple triac driving circuit using the MOC3011. The maximum surge current rating of the MOC3011 sets the minimum value of R1 through the equation:

$$R1(\min) = V_{in(pk)} / 1.2 A$$

If we are operating on the 115 Vac nominal line voltage, $V_{in(pk)} = 180 V$, then

$$R1(\min) = V_{in(pk)} / 1.2 A = 150 \text{ ohms.}$$

In practice, this would be a 150 or 180 ohm resistor. If the triac has $I_{GT} = 100 \text{ mA}$ and $V_{GT} = 2 V$, then the voltage V_{in} necessary to trigger the triac will be given by $V_{inT} = R1 \cdot I_{GT} + V_{GT} + V_{TM} = 20 V$.

Resistive Loads

When driving resistive loads, the circuit of Figure 3 may be used. Incandescent lamps and resistive heating elements are the two main classes of resistive loads for which 115 Vac is utilized. The main restriction is that the triac must be properly chosen to sustain the proper inrush loads. Incandescent lamps can sometimes draw a peak current known as "flashover" which can be extremely high, and the triac should be protected by a fuse or rated high enough to sustain this current.

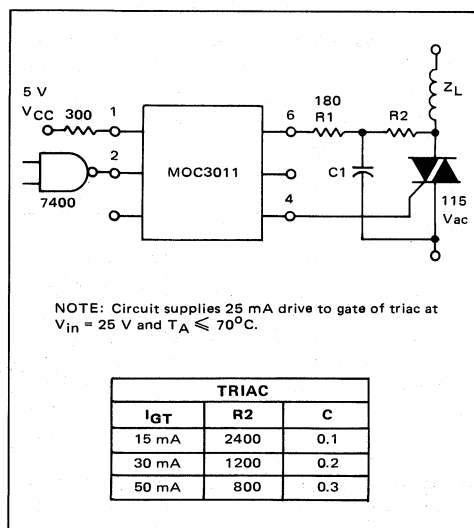

FIGURE 4 — Logic to Inductive Load Interface

Line Transients—Static dv/dt

Occasionally transient voltage disturbance on the ac line will exceed the static dv/dt rating of the MOC3011. In this case, it is possible that the MOC3011 and the associated triac will be triggered on. This is usually not a problem, except in unusually noisy environments, because the MOC3011 and its triac will commute off at the next zero crossing of the line voltage, and most loads are not noticeably affected by an occasional single half-cycle of applied power. See Figure 5 for typical dv/dt versus temperature curves.

Inductive Loads—Commutating dv/dt

Inductive loads (motors, solenoids, magnets, etc.) present a problem both for triacs and for the MOC3011 because the voltage and current are not in phase with each other. Since the triac turns off at zero current, it may be trying to turn off when the applied current is zero but the applied voltage is high. This appears to the triac like a sudden rise in applied voltage, which turns on the triac if the rate of rise exceeds the commutating dv/dt of the triac or the static dv/dt of the MOC3011.

Snubber Networks

The solution to this problem is provided by the use of "snubber" networks to reduce the rate of voltage rise seen by the device. In some cases, this may require two snubbers—one for the triac and one for the MOC3011. The triac snubber is dependent upon the triac and load used and will not be discussed here. In many applications

the snubber used for the MOC3011 will also adequately protect the triac.

In order to design a snubber properly, one should really know the power factor of the reactive load, which is defined as the cosine of the phase shift caused by the load. Unfortunately, this is not always known, and this makes snubbing network design somewhat empirical. However a method of designing a snubber network may be defined, based upon a typical power factor. This can be used as a "first cut" and later modified based upon experiment.

Assuming an inductive load with a power factor of PF = 0.1 is to be driven. The triac might be trying to turn off when the applied voltage is given by

$$V_{to} = V_{pk} \sin \phi \approx V_{pk} \approx 180 \text{ V}$$

First, one must choose R1 (Figure 4) to limit the peak capacitor discharge current through the MOC3011. This resistor is given by

$$R1 = V_{pk} / I_{max} = 180 / 1.2 \text{ A} = 150 \Omega$$

A standard value, 180 ohm resistor can be used in practice for R1.

It is necessary to set the time constant for $\tau = R_2C$. Assuming that the triac turns off very quickly, we have a peak rate of rise at the MOC3011 given by

$$dv/dt = V_{to} / \tau = V_{to} / R_2C$$

Setting this equal to the worst case dv/dt (static) for the MOC3011 which we can obtain from Figure 5 and solving for R2C:

$$dv/dt(T_J = 70^\circ\text{C}) = 0.8 \text{ V}/\mu\text{s} = 8 \times 10^5$$

$$R_2C = V_{to} / (dv/dt) = 180 / (8 \times 10^5) \approx 230 \times 10^{-6}$$

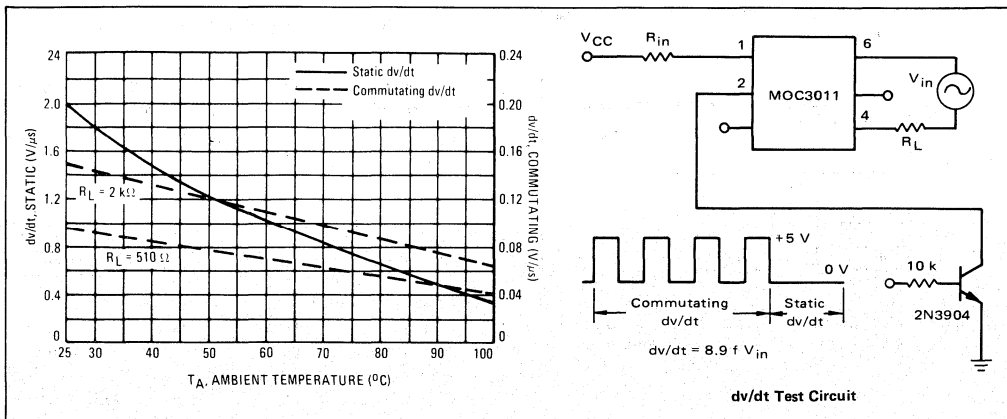

FIGURE 5 — dv/dt versus Temperature

AN780A

The largest value of R₂ available is found, taking into consideration the triac gate requirements. If a sensitive gate triac is used, such as a 2N6071B, I_{GT} = 15 mA @ -40°C. If the triac is to be triggered when V_{in} ≤ 40 V

$$(R_1 + R_2) \approx V_{in}/I_{GT} \approx 40/0.015 \approx 2.3 \text{ k}$$

If we let R₂ = 2400 ohms and C = 0.1 μF, the snubbing requirements are met. Triacs having less sensitive gates will require that R₂ be lower and C be correspondingly higher as shown in Figure 4.

INPUT CIRCUITRY

Resistor Input

When the input conditions are well controlled, as for example when driving the MOC3011 from a TTL, DTL, or HTL gate, only a single resistor is necessary to interface the gate to the input LED of the MOC3011. This resistor should be chosen to set the current into the LED to be a minimum of 10 mA but no more than 50 mA. 15 mA is a suitable value, which allows for considerable degradation of the LED over time, and assures a long operating life for the coupler. Currents higher than 15 mA do not improve performance and may hasten the aging process inherent in LED's. Assuming the forward drop to be 1.5 V at

15 mA allows a simple formula to calculate the input resistor.

$$R_i = (V_{CC} - 1.5)/0.015$$

Examples of resistive input circuits are seen in Figures 2 and 6.

Increasing Input Sensitivity

In some cases, the logic gate may not be able to source or sink 15 mA directly. CMOS, for example, is specified to have only 0.5 mA output, which must then be increased to drive the MOC3011. There are numerous ways to increase this current to a level compatible with the MOC3011 input requirements; an efficient way is to use the MC14049B shown in Figure 6. Since there are six such buffers in a single package, the user can have a small package count when using several MOC3011's in one system.

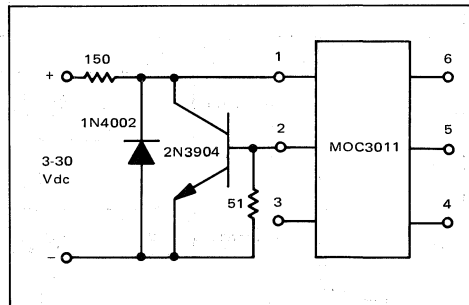

FIGURE 7 – MOC3011 Input Protection Circuit

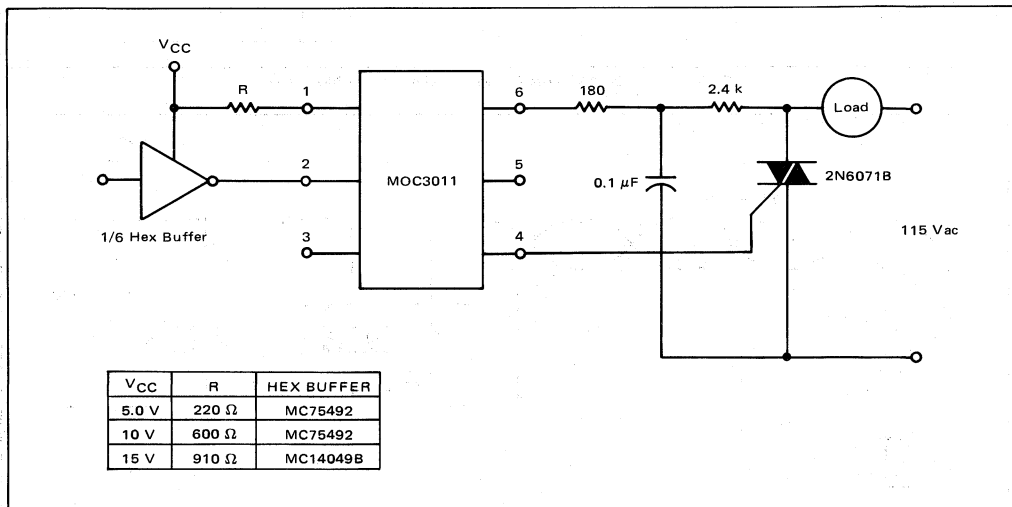

FIGURE 6 – MOS to ac Load Interface

Input Protection Circuits

In some applications, such as solid state relays, in which the input voltage varies widely the designer may want to limit the current applied to the LED of the MOC3011. The circuit shown in Figure 7 allows a non-critical range of input voltages to properly drive the MOC3011 and at the same time protects the input LED from inadvertent application of reverse polarity.

LED Lifetime

All light emitting diodes slowly decrease in brightness during their useful life, an effect accelerated by high temperatures and high LED currents. To allow a safety margin and insure long service life, the MOC3011 is actually tested to trigger at a value lower than the specified 10 mA input threshold current. The designer can therefore design the input circuitry to supply 10 mA to the LED and still be sure of satisfactory operation over

a long operating lifetime. On the other hand, care should be taken to insure that the maximum LED input current (50 mA) is not exceeded or the lifetime of the MOC3011 may be shortened.

APPLICATIONS EXAMPLES

Using the MOC3011 on 240 Vac Lines

The rated voltage of a MOC3011 is not sufficiently high for it to be used directly on 240 Vac line; however, the designer may stack two of them in series. When used this way, two resistors are required to equalize the voltage dropped across them as shown in Figure 8.

Remote Control of ac Voltage

Local building codes frequently require all 115 Vac light switch wiring to be enclosed in conduit. By using a MOC3011, a triac, and a low voltage source, it is

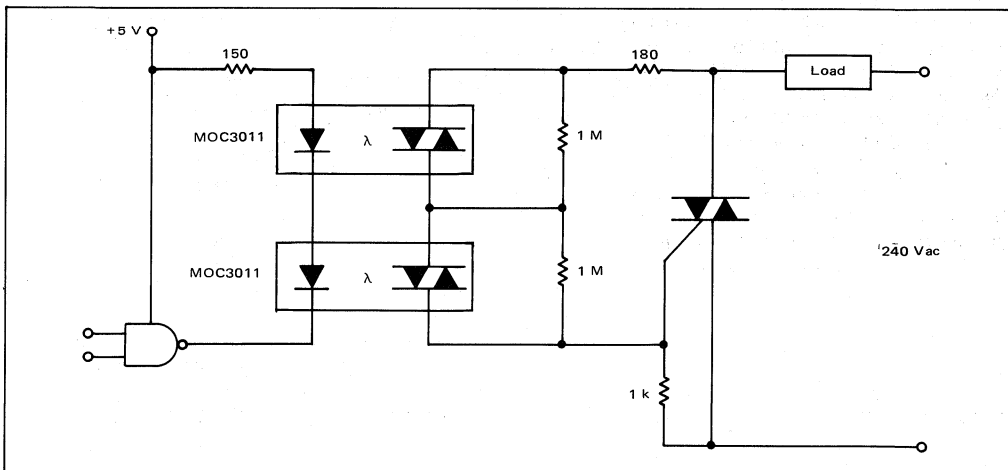

FIGURE 8 – 2 MOC3011 Triac Drivers in Series to Drive 240 V Triac

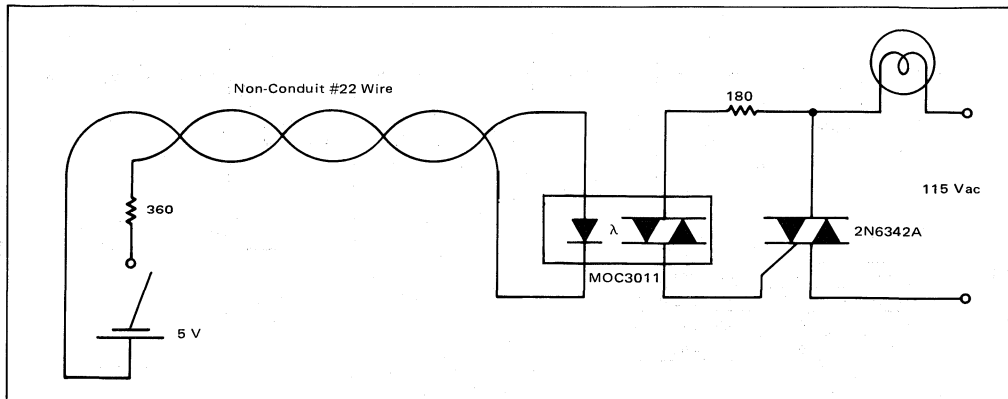

FIGURE 9 – Remote Control of ac Loads Through Low Voltage Non-Conduit Cable

possible to control a large lighting load from a long distance through low voltage signal wiring which is completely isolated from the ac line. Such wiring usually is not required to be put in conduit, so the cost savings in installing a lighting system in commercial or residential buildings can be considerable. An example is shown in Figure 9. Naturally, the load could also be a motor, fan, pool pump, etc.

Solid State Relay

Figure 10 shows a complete general purpose, solid state relay snubbed for inductive loads with input protection. When the designer has more control of the input and output conditions, he can eliminate those components which are not needed for his particular application to make the circuit more cost effective.

Interfacing Microprocessors to 115 Vac Peripherals

The output of a typical microcomputer input-output

(I/O) port is a TTL-compatible terminal capable of driving one or two TTL loads. This is not quite enough to drive the MOC3011, nor can it be connected directly to an SCR or triac, because computer common is not normally referenced to one side of the ac supply. Standard 7400 series gates can provide an input compatible with the output of an MC6820, MC6821, MC6846 or similar peripheral interface adaptor and can directly drive the MOC3011. If the second input of a 2 input gate is tied to a simple timing circuit, it will also provide energization of the triac only at the zero crossing of the ac line voltage as shown in Figure 11. This technique extends the life of incandescent lamps, reduces the surge current strains on the triac, and reduces EMI generated by load switching. Of course, zero crossing can be generated within the microcomputer itself, but this requires considerable software overhead and usually just as much hardware to generate the zero-crossing timing signals.

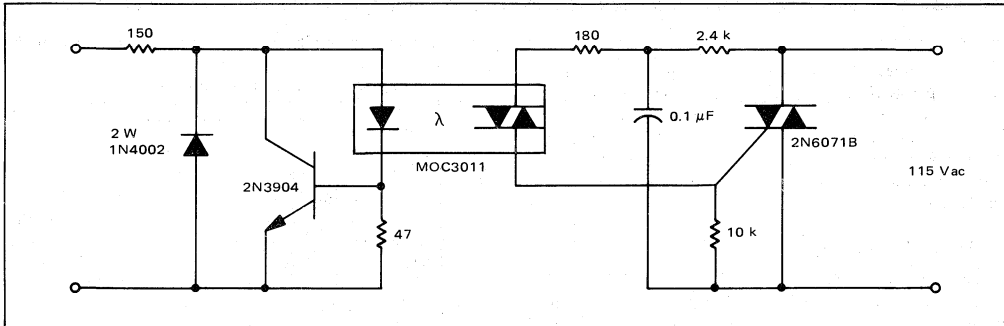

FIGURE 10 – Solid-State Relay

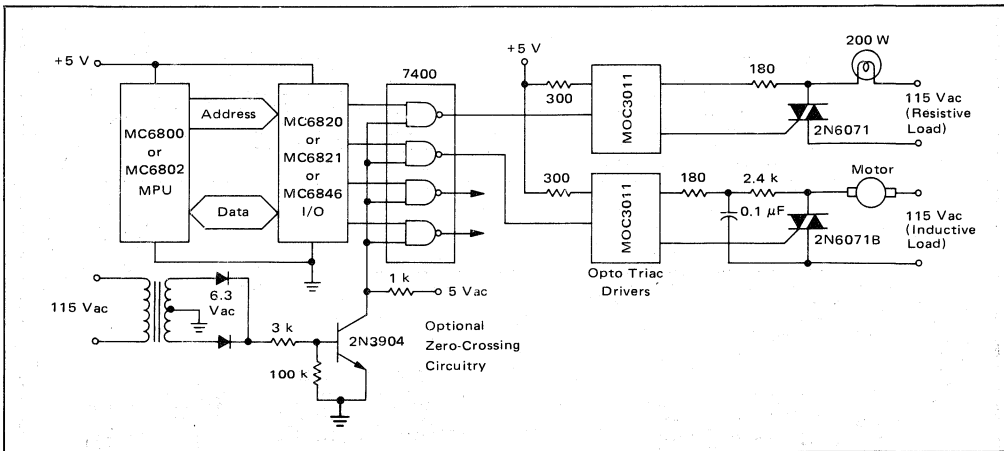

FIGURE 11 – Interfacing an M6800 Microcomputer System to 115 Vac Loads

BASIC CONCEPTS OF FIBER OPTICS AND FIBER OPTIC COMMUNICATIONS

Prepared By
John Bliss

Product Manager, Fiber Optic Products High Frequency & Optical Products Group
Motorola Semiconductor Products Sector

Introduction

This note presents an introduction to the principles of fiber optics. Its purpose is to review some basic concepts from physics that relate to fiber optics and the application of semiconductor devices to the generation and detection of light transmitted by optical fibers. The discussion begins with a description of a fiber optic link and the inherent advantages of fiber optics over wired systems.

A Fiber Optic Link

Webster gives as one definition of a link "something which binds together or connects." In fiber optics, a link is the assembly of hardware which connects a source of a signal with its

ultimate destination. The items which comprise the assembly are shown in Figure 1. As the figure indicates, an input signal, for example, a serial digital bit stream, is used to modulate a light source, typically an LED (light emitting diode). A variety of modulation schemes can be used. These will be discussed later. Although the input signal is assumed to be a digital bit stream, it could just as well be an analog signal, perhaps video.

The modulated light must then be coupled into the optical fiber. This is a critical element of the system. Based on the coupling scheme used, the light coupled into the fiber could be two orders of magnitude less than the total power of the source.

Once the light has been coupled into the fiber, it is attenuated as it travels along the fiber. It is also subject to distortion. The degree of distortion limits the maximum data rate that can be transmitted through the fiber.

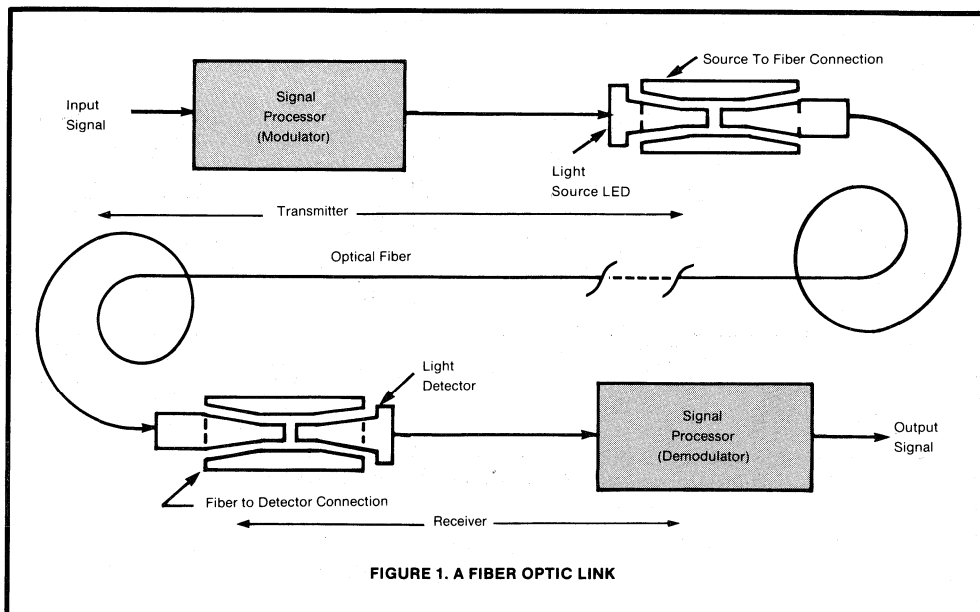

FIGURE 1. A FIBER OPTIC LINK

At the receive end of the fiber, the light is coupled into a detector element (like a photo diode). The coupling problem at this stage, although still of concern, is considerably less severe than at the source end. The detector signal is then reprocessed or decoded to reconstruct the original input signal.

A link like that described in Figure 1 can be fully transparent to the user. That is, everything from the input signal connector to the output signal connector can be prepackaged. Thus, the user need only be concerned with supplying a signal of some standard format and level (like NRZ T²L) and extracting a similar signal. Such a T²L in/T²L out system obviates the need for a designer to understand fiber optics. However, by analyzing the problems and concepts internal to the link, the user is better prepared to apply fiber optics technology to his system.

Advantages of Fiber Optics

There are both performance and cost advantages to be realized by using fiber optics over wire.

Greater Bandwidth. The higher the carrier frequency in a communication system, the greater its potential signal bandwidth. Since fiber optics work with carrier frequencies on the order of 10^{13} - 10^{14} Hz as compared to radio frequencies of 10^6 - 10^8 Hz, signal bandwidths are theoretically 10^6 times greater.

Smaller size and weight. A single fiber is capable of replacing a very large bundle of individual copper wire. For example, a typical telephone cable may contain over 1,000 pairs of copper wire and have a cross-sectional diameter of seven to ten centimeters. A single glass fiber cable capable of handling the same amount of signal might be only one-half centimeter in diameter. The actual fiber may be as small as 50μ -meters. The additional size is the jacket and strength elements. The weight reduction in this example should be obvious.

Lower attenuation. Length for length, optical fiber exhibits less attenuation than does twisted wire or coaxial cable. Also,

the attenuation of optical fibers, unlike that of wire, is not signal frequency dependent.

Freedom from EMI. Unlike wire, glass does not pick up nor generate electro-magnetic interference (EMI). Optical fibers do not require expensive shielding techniques to desensitize them to stray fields.

Ruggedness. Glass is 20 times stronger than steel and since glass is relatively inert, corrosive environments are of less concern than with wired systems.

Safety. In many wired systems, the potential hazard of short circuits between wires or from wires to ground, requires special precautionary designs. The dielectric nature of optic fibers eliminates this requirement and the concern for hazardous sparks occurring during interconnects.

Lower Cost. Optical fiber costs are continuing to decline while the cost of wire is increasing. In many applications today, the total system cost for a fiber optic design is lower than for a comparable wired design. As time passes, more and more systems will be decidedly less expensive with optical fibers.

Physics of Light

The performance of optical fibers can be fully analyzed by application of Maxwell's Equations for electromagnetic fields. However, these are necessarily complex and, fortunately, can be bypassed for most users by the application of geometric ray tracing and analysis. When considering LEDs and photo detectors, the particle theory of light is used. The change from ray to particle theory is fortunately a simple step.

Over the years, it has been demonstrated that light (in fact, all electromagnetic energy) travels at approximately 300,000 km/second in free space. It has also been demonstrated that in materials denser than free space, the speed of light is reduced. This reduction in the speed of light as it passes from free space into a denser material results in refraction of the light. Simply

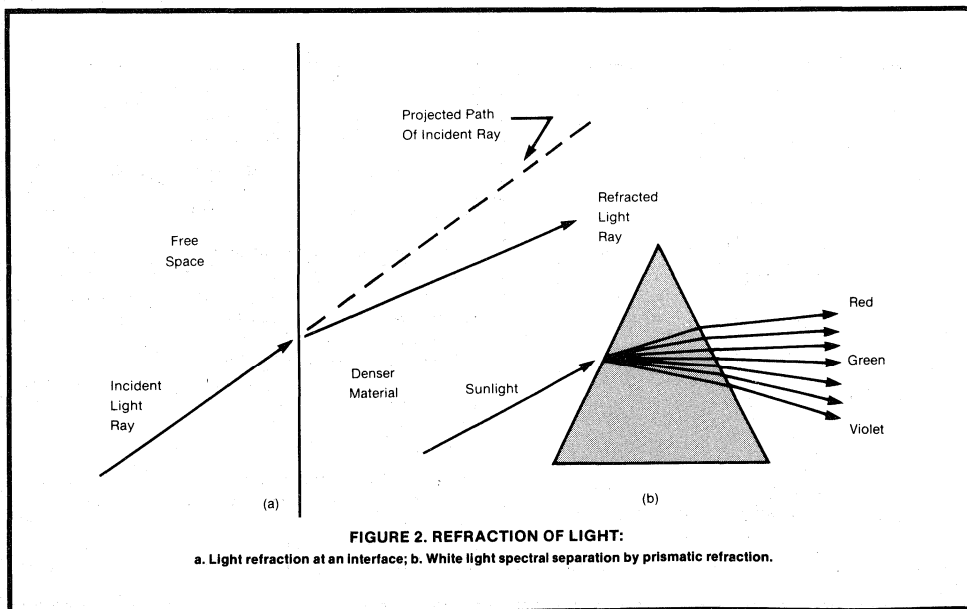

stated, the light ray is bent at the interface. This is shown in Figure 2a. In fact, the reduction of the speed of light is different for different wavelengths; and, therefore, the degree of bending is different for each wavelength. It is this variation in effect for different wavelengths that results in rainbows. Water droplets in the air act like small prisms (Figure 2b) to split white sunlight into the visible spectrum of colors.

The actual bend angle at an interface is predictable and depends on the refractive index of the dense material. The refractive index, usually given the symbol n , is the ratio of the speed of light in free space to its speed in the denser material:

$$n = \frac{\text{speed of light in free space}}{\text{speed of light in given material}} \quad (1)$$

Although n is also a function of wavelength, the variation in many applications is small enough to be ignored and a single value is given. Some typical values of n are given in Table 1:

Table 1
Representative Indices of Refraction

| | |
|------------------------|--------------|
| Vacuum | 1.0 |
| Air | 1.0003 (1.0) |
| Water | 1.33 |
| Fused Quartz | 1.46 |
| Glass | 1.5 |
| Diamond | 2.0 |
| Silicon | 3.4 |
| Gallium-Arsenide | 3.6 |

It is interesting to consider what happens to a light ray as it meets the interface between two transmissive materials. Figure 3 shows two such materials of refractive indices n_1 and n_2 . A light ray is shown in material 1 and incident on the interface at point P. Snell's law states that:

$$n_1 \sin\theta_1 = n_2 \sin\theta_2 \quad (2)$$

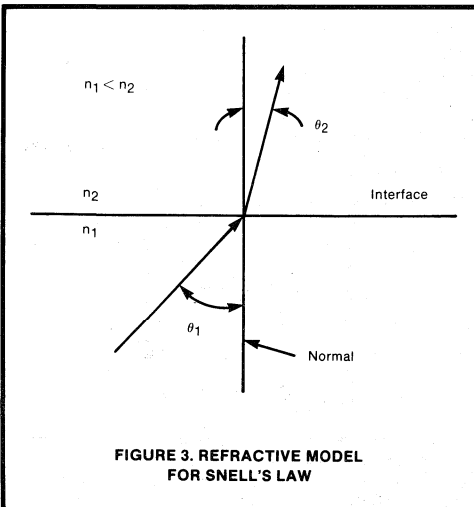

The angle of refraction, θ_2 , can be determined:

$$\sin\theta_2 = \frac{n_1}{n_2} \sin\theta_1 \quad (3)$$

If material 1 is air, n_1 has the value of 1; and since n_2 is greater than 1, θ_2 is seen to be less than θ_1 ; that is, in passing through the interface, the light ray is refracted (bent) toward the normal.

If material 1 is not air but still has an index of refraction less than material 2, the ray will still be bent toward the normal. Note that if n_2 is less than n_1 , θ_2 is greater than θ_1 , or the ray is refracted away from the normal.

Consider Figure 4 in which an incident ray is shown at an angle such that the refracted ray is along the interface or the angle of refraction is 90° . Note that $n_1 > n_2$. Using Snell's law:

$$\sin\theta_2 = \frac{n_1}{n_2} \sin\theta_1 \quad (4)$$

or, with θ_2 equal to 90° :

$$\sin\theta_1 = \frac{n_2}{n_1} = \sin\theta_c \quad (5)$$

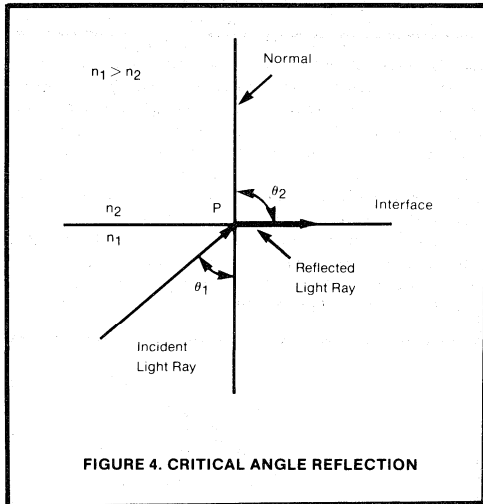

The angle, θ_c , is known as the critical angle and defines the angle at which incident rays will not pass through the interface. For angles greater than θ_c , 100 percent of the light rays are reflected (as shown in Figure 5), and the angle of incidence equals the angle of reflection.

This characteristic of reflection for light incident at greater than the critical angle is a fundamental concept in fiber optics.

Optical Fibers

Figure 6 shows the typical construction of an optical fiber. The central portion, or core, is the actual propagating path for light. Although the core is occasionally constructed of plastic, it is more typically made of glass. The choice of material will be discussed later. Bonded to the core is a cladding layer — again,

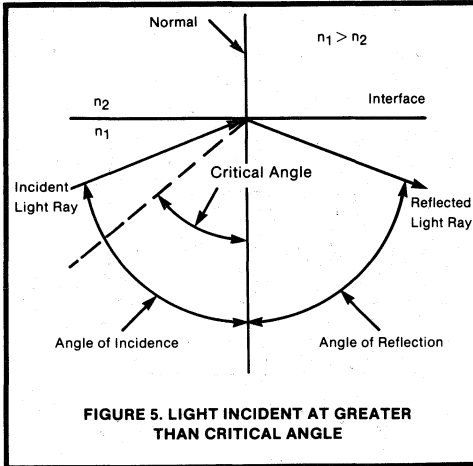

FIGURE 5. LIGHT INCIDENT AT GREATER THAN CRITICAL ANGLE

usually glass, although plastic cladding of glass core is not uncommon. The composition of glass can be tailored during processing to vary the index of refraction. For example, an all-glass, or silica-clad fiber, may have the compositions set so that the core material has an index of refraction of 1.5; and the clad has an index of refraction of 1.485. To protect the clad fiber, it is typically enclosed in some form of protective rubber or plastic jacket. This type of optical fiber is called a "step index multimode" fiber. Step index refers to the profile of the index of refraction across the fiber (as shown in Figure 7). The core has an essentially constant index n_1 . The classification "multimode" should be evident shortly.

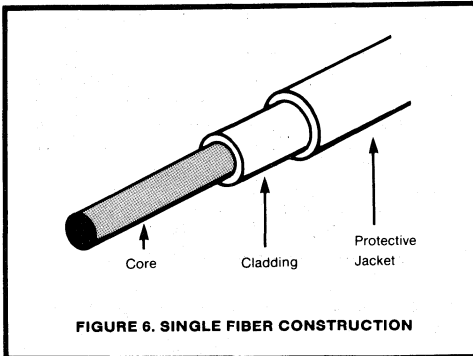

FIGURE 6. SINGLE FIBER CONSTRUCTION

Numerical Aperture

Applying the concept of total internal reflection at the $n_1 n_2$ interface, we can now demonstrate the propagation of light along the fiber core and the constraint on light incident on the fiber end to ensure propagation. Figure 8 illustrates the analysis. As the figure shows, ray propagation results from the continuous reflection at the core/clad interface such that the ray bounces down the fiber length and ultimately exits at the

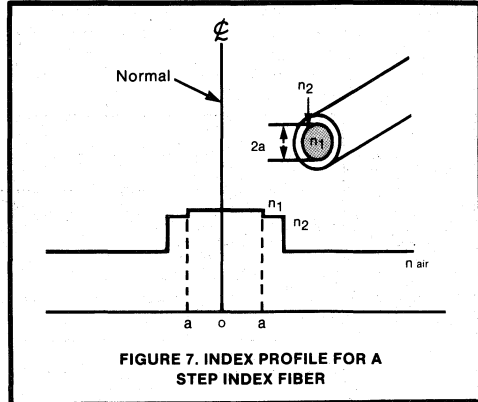

FIGURE 7. INDEX PROFILE FOR A STEP INDEX FIBER

far end. If the principle of total internal reflection is applied at point P, the critical angle value for θ_3 is found by Snell's law:

$$\theta_c = \theta_3 (\text{min}) = \sin^{-1} \frac{n_2}{n_1} \tag{6}$$

Now, since θ_2 is a complementary angle to θ_3 ,

$$\theta_2 (\text{max}) = \sin^{-1} \frac{(n_1^2 - n_2^2)^{1/2}}{n_1} \tag{7}$$

Again applying Snell's law at the entrance surface (recall $n_{\text{air}} = 1$),

$$\sin \theta_{\text{in}} (\text{max}) = n_1 \sin \theta_2 (\text{max}) \tag{8}$$

Combining (7) and (8),

$$\sin \theta_{\text{in}} (\text{max}) = (n_1^2 - n_2^2)^{1/2} \tag{9}$$

$\theta_{\text{in}} (\text{max})$ represents the largest angle with the normal to the fiber end for which total internal reflection will occur at the core/clad interface. Light rays entering the fiber end at angles greater than $\theta_{\text{in}} (\text{max})$ will pass through the interface at P and be lost. The value $\sin \theta_{\text{in}} (\text{max})$ is one of the fundamental parameters for an optical fiber. It defines the half-angle of the cone of acceptance for light to be propagated along the fiber and is called the "numerical aperture", usually abbreviated N.A.

$$\text{N.A.} = \sin \theta_{\text{in}} (\text{max}) = (n_1^2 - n_2^2)^{1/2} \tag{10}$$

There are several points to consider about N.A. and equation (10). Recall that in writing (8), we assumed that the material at the end of the fiber was air with an index of 1. If it were some other material, (8) would be written with n_3 representing the material:

$$n_3 \sin \theta_{\text{in}} (\text{max}) = n_1 \sin \theta_2 (\text{max}) \tag{11}$$

and, combining (7) and (11),

$$\sin \theta_{\text{in}} (\text{max}) = \frac{(n_1^2 - n_2^2)^{1/2}}{n_3} \text{N.A.} \tag{12}$$

That is, the N.A. would be reduced by the index of refraction of the end material. When fiber manufacturers specify N.A., it is usually given for an air interface unless otherwise stated.

The second point concerns the absoluteness of N.A. The analysis assumed that the light rays entered the fiber, and in propagating along it, they continually passed through the

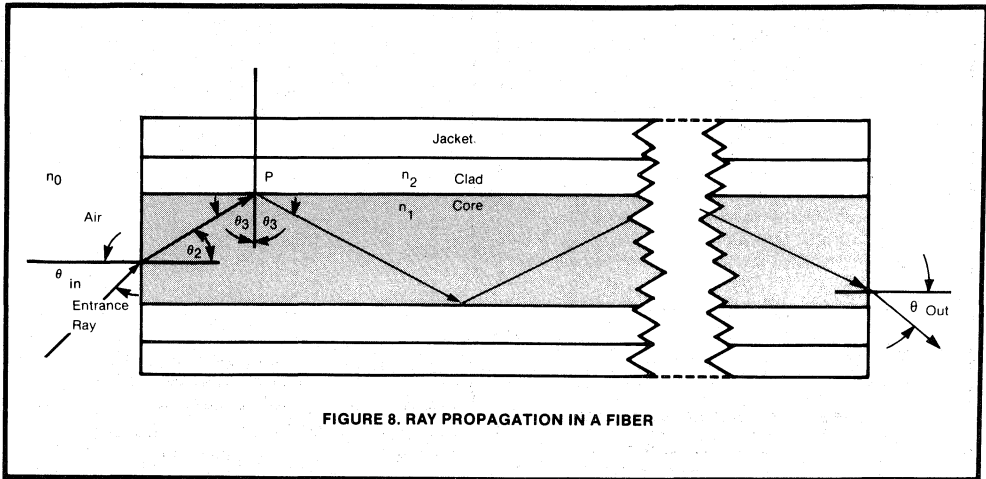

FIGURE 8. RAY PROPAGATION IN A FIBER

central axis of the fiber. Such rays are called "meridional" rays. It is entirely possible that some rays may enter the fiber at such an angle that in passing down the fiber, they never intercept the axis. Such rays are called "skew" rays. An example is shown in both side and end views in Figure 9.

of measuring a fiber's N.A. In the measurement, a sample to be measured (at least 1 meter to allow the attenuation of clad and high order modes¹) is connected to a high N.A. radiometric sensor, such as a large-area photodiode. The power detected by the sensor is read on a radiometer power meter. The other end

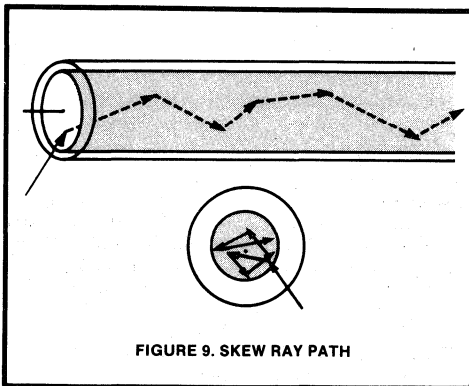

FIGURE 9. SKEW RAY PATH

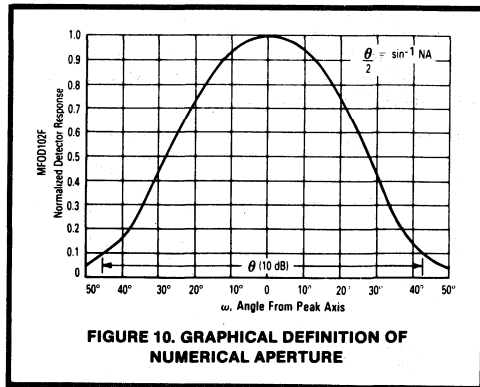
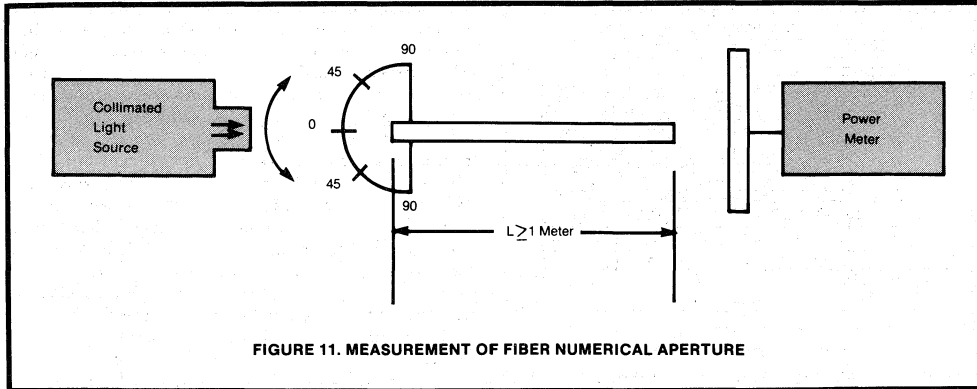

FIGURE 10. GRAPHICAL DEFINITION OF NUMERICAL APERTURE

Also, some rays may enter at angles very close to the critical angle. In bouncing along the fiber, their path length may be considerably longer than rays at shallower angles. Consequently, they are subject to a larger probability of absorption and may, therefore, never be recovered at the output end. However, for very short lengths of fiber, they may not be lost. These two effects, plus the presence of light in the cladding for short lengths, results in the N.A. not cutting off sharply according to equations (10) and (12) and of appearing larger for short lengths. It is advisable to define some criteria for specifying N.A. At Motorola, N.A. is taken as the acceptance angle for which the response is no greater than 10 dB down from the peak value. This is shown in Figure 10. Figure 11 shows a typical method

of the fiber is mounted on a rotatable fixture such that the axis of rotation is the end of the fiber. A collimated light source is directed at the end of the fiber. This can be a laser or other source, such as an LED, at a sufficient distance to allow the rays entering the fiber to be paraxial. The fiber end is adjusted to find the peak response position. Ideally, this will be at zero degrees; but manufacturing variations could result in a peak slightly offset from zero. The received power level is noted at the peak. The fiber end is then rotated until the two points are found at which the received power is one-tenth the peak value. The sine of half the angle between these two points is the N.A.

¹High order modes refers to steep angle rays.



The apparent N.A. of a fiber is a function of the N.A. of the source that is driving it. For example, Figures 12a and 12b are plots of N.A. versus length for the same fiber. In (12a) the source has a large N.A. (0.7), while in (12b) the source N.A. is 0.32. Note that in both cases, the N.A. at 100m is about 0.31; but at 1 meter, the apparent N.A. is 0.42 in (12a) but 0.315 in (12b). The high order modes entering the fiber from the 0.7 N.A. source take nearly the full 100 meters to be stripped out by attenuation. Thus, a valid measurement of a fiber's true N.A. requires a collimated, or very low, N.A. source or a very long-length sample.

Fiber Attenuation

Mention was made above of the "stripping" or attenuation of high order modes due to their longer path length. This suggests that the attenuation of power in a fiber is a function of length. This is indeed the case. A number of factors contribute to the attenuation: imperfections at the core/clad interface; flaws in the consistency of the core material; impurities in the composition. The surface imperfections and material flaws tend to affect all wavelengths. The impurities tend to be selective in

the wavelength they affect. For example, hydroxyl molecules (OH⁻) are strong absorbers of light at 900 nm. Therefore, if a fiber manufacturer wants to minimize losses at 900 nm, he will have to take exceptional care in his process to eliminate moisture (the source of OH⁻). Other impurities are also present in any manufacturing process. The degree to which they are controlled will determine the attenuation characteristic of a fiber. The cumulative effect of the various impurities results in plots of attenuation versus wavelength exhibiting peaks and valleys. Four examples of attenuation (given in dB/km) are shown in Figure 13.

Fiber Types

It was stated at the beginning of this section that fibers be made of glass or plastic. There are three varieties available today:

1. Plastic core and cladding;
2. Glass core with plastic cladding — often called 'PCS' (plastic-clad silica);
3. Glass core and cladding — silica-clad silica.

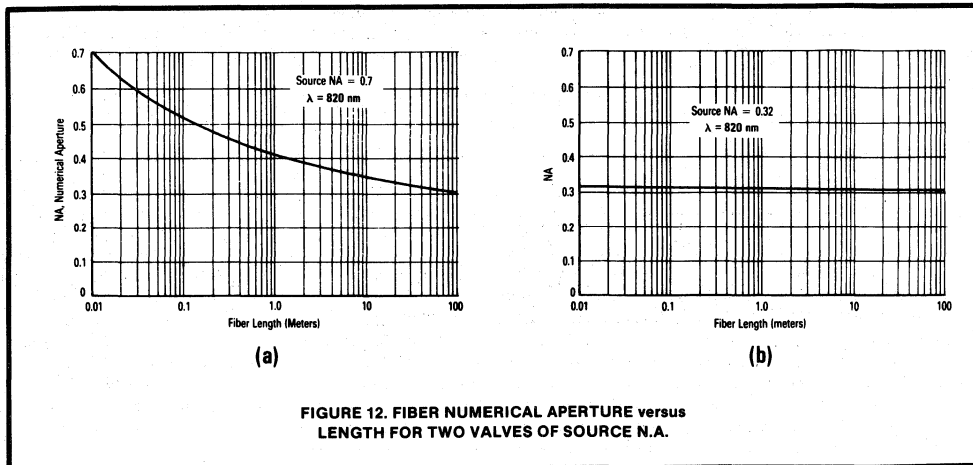

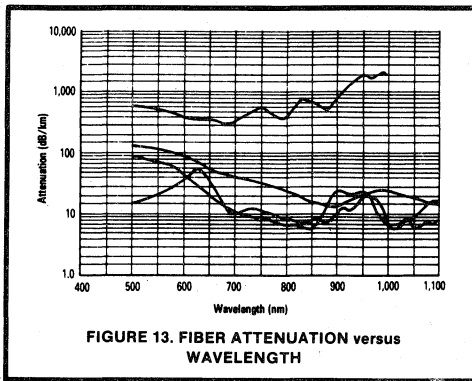

All plastic fibers are extremely rugged and useful for systems where the cable may be subject to rough day-after-day treatment. They are particularly attractive for benchtop interconnects. The disadvantage is their high attenuation characteristic.

PCS cables offer the better attenuation characteristics of glass and are less affected by radiation than all-glass fibers.² They see considerable use in military-grade applications.

All glass fibers offer low attenuation performance and good concentricity, even for small-diameter cores. They are generally easy to terminate, relative to PCS. On the down side, they are usually the least rugged, mechanically, and more susceptible to increases in attenuation when exposed to radiation.

The choice of fiber for any given application will be a function of the specific system's requirements and trade-off options.

So far, the discussion has addressed single fibers. Fibers, particularly all-plastic, are frequently grouped in bundles. This is usually restricted to very low-frequency, short-distance applications. The entire bundle would interconnect a single light source and sensor or could be used in a fan-out at either end. Bundles are also available for interconnecting an array of

²It should be noted that the soft clad material should be removed and replaced by a hard clad material for best fiber core-to-connector termination.

sources with a matched array of detectors. This enables the interconnection of multiple discrete signal channels without the use of multiplex techniques. In this type of cable, the individual fibers are usually separated in individual jackets and, perhaps, each embedded in clusters of strength elements, like Kevlar. In one special case bundle, the fibers are arrayed in a ribbon configuration. This type cable is frequently seen in telephone systems using fiber optics.

In Figure 7, the refractive index profile was shown as constant over the core cross-section with a step reduction at the core/clad interface. The core diameter was also large enough that many modes (low and high order) are propagated along its path. In Figure 14, a section of this fiber is shown with three discrete modes shown propagating down the fiber. The lowest order mode is seen traveling parallel to the axis of the fiber. The middle order mode is seen to bounce several times at the interface. The total path length of this mode is certainly greater than that of the mode along the axis. The high order mode is seen to make many trips across the fiber, resulting in an extremely long path length.

The signal input to this fiber is seen as a step pulse of light. However, since all the light that enters the fiber at a fixed time does not arrive at the end at one time (the higher modes take longer to traverse their longer path), the net effect is to stretch or distort the pulse. This is characteristic of a multimode, step-index fiber and tends to limit the range of frequency for the data being propagated.

Figure 15 shows what this pulse stretching can do. An input pulse train is seen in (15a). At some distance (say 100 meters), the pulses (due to dispersion) are getting close to running together but are still distinguishable and recoverable. However, at some greater distance (say 200 meters), the dispersion has resulted in the pulses running together to the degree that they are indistinguishable. Obviously, this fiber would be unusable at 200 meters for this data rate. Consequently, fiber specifications usually give bandwidth in units of MHz-km — that is, a 200 MHz-km cable can send 200 MHz data up to 1.0 km or 100 MHz data up to 2.0 km etc.

To overcome the distortion due to path length differences, fiber manufacturers have developed graded index fiber. An example of multimode, graded-index fiber is shown in Figure 16.

In the fiber growth process, the profile of the index of refraction is tailored to follow the parabolic profile shown in the

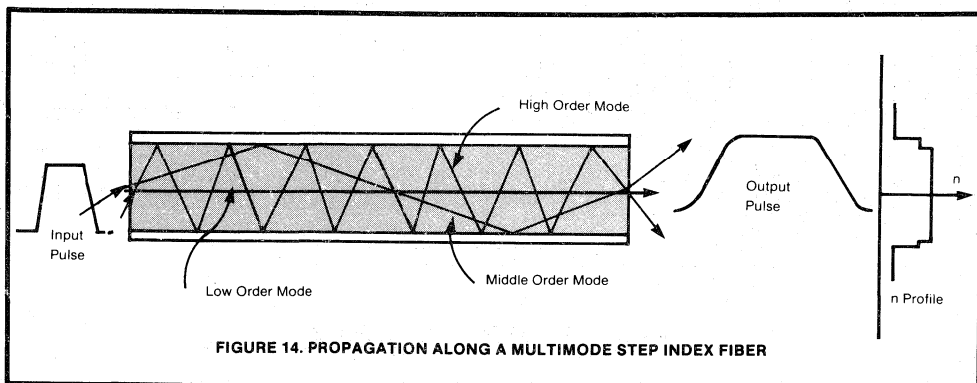

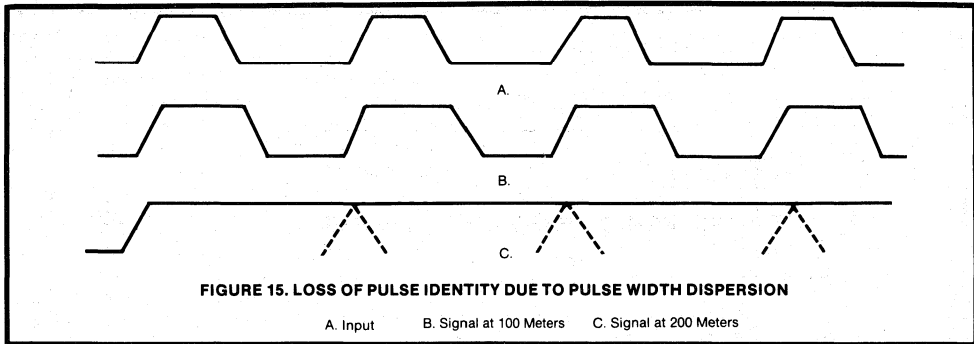

figure. This results in low order modes traveling through a constant density material. High order modes see lower density material as they get further away from the axis of the core. Thus, the velocity of propagation increases away from the center. The result is that all modes, although they may travel different distances, tend to cover the length of the fiber in the same amount of time. This yields a fiber with higher bandwidth capability than multimode stepped index.

One more fiber type is also available. This is the single mode, step-index fiber shown in Figure 17. In this fiber, the core is extremely small (on the order of just a few micrometers). This type accepts only the lowest order mode and suffers no modal dispersion. It is an expensive fiber and requires a very high-power, highly-directional source like a laser diode. Consequently, applications for this type of fiber are the very high data rate, long-distance systems.

As a final statement on fiber properties, it is interesting to compare optical fiber with coax cable. Figure 18 shows the loss versus frequency characteristics for a low-loss fiber compared with the characteristics of several common coax cables. Note that the attenuation of optical fiber is independent of frequency (up to the point where modal dispersion comes into play).

Active Components For Fiber Optics

Propagation through fiber optics is in the form of light or, more specifically, electromagnetic radiation in the spectral

range of near-infrared or visible light. Since the signal levels to be dealt with are generally electrical in nature (like serial digital logic at standard T²L levels), it is necessary to convert the source signal into light at the transmitter end and from light back to T²L at the receive end. There are several components which can accomplish these conversions. This discussion will concentrate on light emitting diodes (LEDs) as sources and PIN photo diodes and Integrated Detector Preamplifiers (IDPs) as sensors.

Light Emitting Diodes

Most people are familiar with LEDs in calculator displays. Just as they are optimized geometrically and visually for the function of displaying characters, some LEDs are specifically designed and processed to satisfy the requirements of generating light, or near infrared for coupling into fibers. There are several criteria of importance for LEDs used with fibers:

1. Output power;
2. Wavelength;
3. Speed;
4. Emission pattern.

Output power. Manufacturers are continually striving to increase the output power or efficiency of LEDs. The more efficient an LED, the lower its drive requirements, or the greater

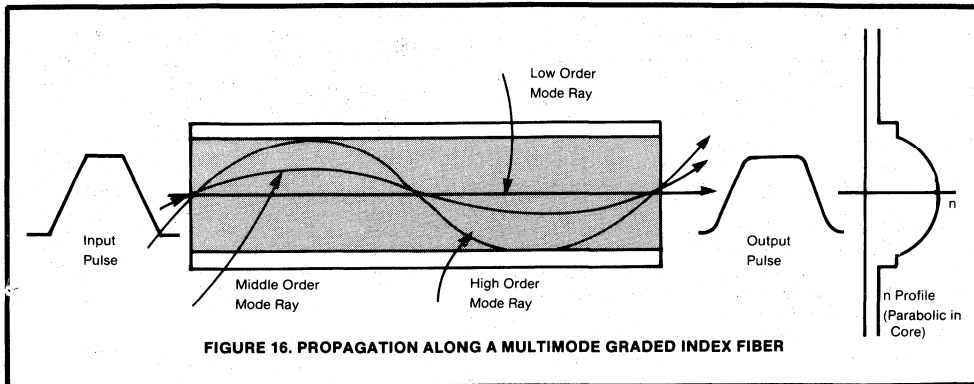

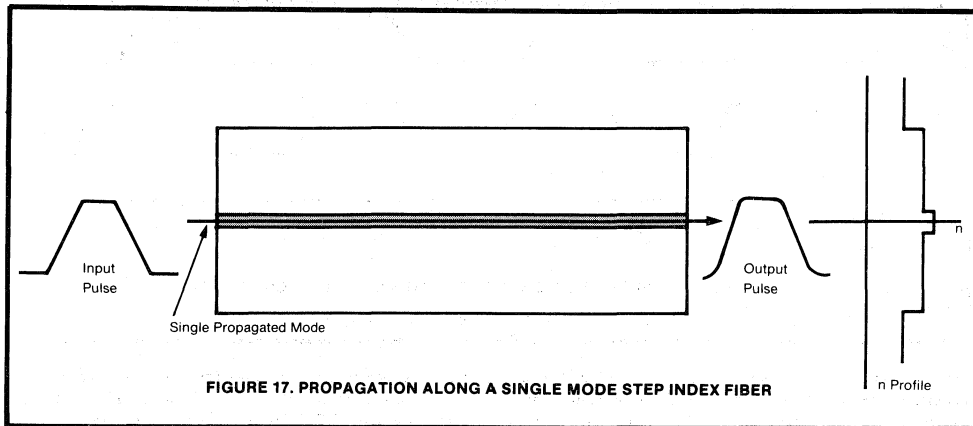

FIGURE 17. PROPAGATION ALONG A SINGLE MODE STEP INDEX FIBER

the losses that can be accommodated elsewhere in the system. However, total power emitted by an LED is not the whole picture (see Emission Pattern).

Wavelength. As shown earlier, optical fibers exhibit an attenuation characteristic that varies with wavelength. Figure 19 is a repeat of one of the sample curves from Figure 13. If this fiber were to be used in a system, the desired wavelength of operation would be about 875 nm where the attenuation is down to about 7.0 dB/km. The most undesirable wavelength for use in this fiber's range is 630 nm where the loss is about 600 dB/km. Therefore, all other considerations being satisfied, an LED with a characteristic emission wavelength of 875 nm would be used.

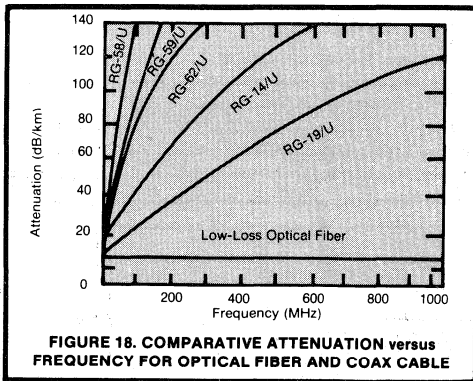

FIGURE 18. COMPARATIVE ATTENUATION versus FREQUENCY FOR OPTICAL FIBER AND COAX CABLE

Speed. LEDs exhibit finite turn-on and turn-off times. A device with a response of 100 ns would never work in a 20 MHz system. (In general, the 3.0 dB bandwidth is equal to 0.35 divided by the risetime.) In a symmetrical RTZ system (see data encoding later in this paper), the pulse width for a single bit would be 25 ns. A 100 ns LED would hardly have begun to turn on when it would be required to turn off. There is often a trade-off between speed and power, so it would not be advisable to select the fas-

test diode available but rather the fastest required to do the job, with some margin designed in.

Emission Pattern. In typical data communications systems the light from the LED is coupled into a fiber with a core diameter of 100 to 200 μm . If the emission pattern of a particular LED is a collimated beam of 100 μm or less diameter, it might be possible to couple nearly all the power into the fiber. Thus, a 100 μW LED with such an emission pattern might be a better choice than a 5.0 mW LED with a lambertian³ pattern.

Light Generation

Light is emitted from an LED as a result of the recombining of electrons and holes. Electrically, an LED is just a P-N junction. Under forward bias, minority carriers are injected across

³Lambertian: The spatial pattern of reflected light from a sheet of paper, e.g. The intensity of light in any direction from a plane lambertian surface is equal to the intensity in the direction of the normal to the surface times the cosine of the angle between the direction and the normal.

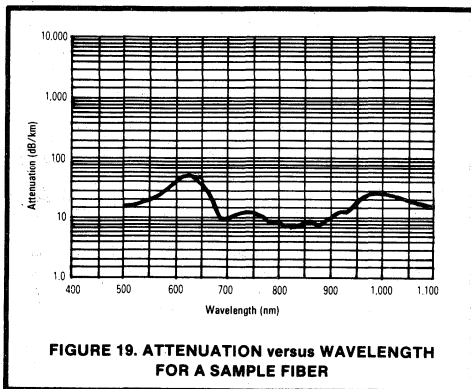

FIGURE 19. ATTENUATION versus WAVELENGTH FOR A SAMPLE FIBER

the junction. Once across, they recombine with majority carriers and give up their energy in the process. The energy given up is approximately equal to the energy gap for the material. The same injection/recombination process occurs in any P-N junction; but in certain materials, the nature of the process is typically radiative — that is, a photon of light is produced. In other materials (silicon and germanium, for example), the process is primarily non-radiative and no photons are generated.

Light emitting materials do have a distribution of non-radiative sites — usually crystal lattice defects, impurities, etc. Minimizing these is the challenge to the manufacturer in his attempt to produce more efficient devices. It is also possible for non-radiative sites to develop over time and, thus, reduce efficiency. This is what gives LEDs finite lifetimes, although 10^5 to 10^6 -hour lifetimes are essentially infinite compared with some other components of many systems.

The simplest LED structures are homojunction, epitaxially-grown devices and single-diffused devices. These structures are shown in Figure 20.

The epitaxially-grown LED is generally constructed of silicon-doped gallium-arsenide. A melt of elemental gallium containing arsenic and silicon dopant is brought in contact at high temperature with the surface of an n-type gallium-arsenide wafer. At the initial growth temperature, the silicon atoms in the dopant replace some of the gallium atoms in the crystal lattice. In so doing, they contribute an excess electron to the bond. This results in the grown layer being n-type. During the growth, the temperature is systematically reduced. At a certain critical temperature, the silicon atoms begin to replace some of the arsenic atoms in the crystal. This removes an electron from the bond, resulting in the formation of a p-type layer. As a finished diode, the entire surface, as well as the four sides, radiate light. The characteristic wavelength of this type of device is 940 nm, and it typically radiates a total power of 3.0 mW at 100 mA forward current. It is relatively slow with turn-on and turn-off times on the order of 150 ns. The non-directionality of its emission makes it a poor choice as a light source for use with optical fibers.

The planar diffused LED is formed by controlled diffusions of zinc into a tellurium-doped n-gallium-arsenide wafer. A finished diode has a typical power output of $500 \mu W$ at a wavelength of 900 nm. Turn-on and turn-off times are usually around 15-20 ns.

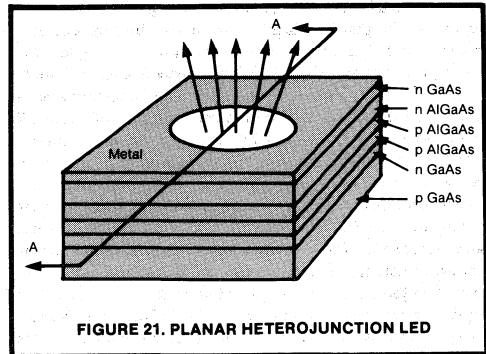

FIGURE 21. PLANAR HETEROJUNCTION LED

The emission pattern is lambertian, similar to the grown junction LED above.

Both of the above structures, although they can be used in fiber optics, are not optimized for the purpose of coupling into small fibers. Several variations of LED structures are currently used to improve the efficiency of light coupling into fibers. The two basic structures for fiber optic LEDs are surface emitting and edge emitting. Surface-emitting devices are further broken down to planar and etched-well devices. The material used for these devices could be gallium-arsenide or any material which exhibits efficient photon-generating ability. The most common material in use today is the ternary crystal aluminum-gallium-arsenide. It is used extensively because it results in very efficient devices and has a characteristic wavelength around 820 nm⁴ at which many fibers give lowest attenuation. (Many fibers are even better around 1300 nm, but the materials technology for LEDs at this wavelength — InGaAsP — is still on the front end of the learning curve; and devices are very expensive.)

Planar Fiber Optic LED

The planar heterojunction LED is somewhat similar to the grown junction LED of Figure 20a. Both utilize the liquid-phase epitaxial process to fabricate the device. The LED shown in

⁴This is adjustable by varying the mix of aluminum in the aluminum-gallium-arsenide crystal.

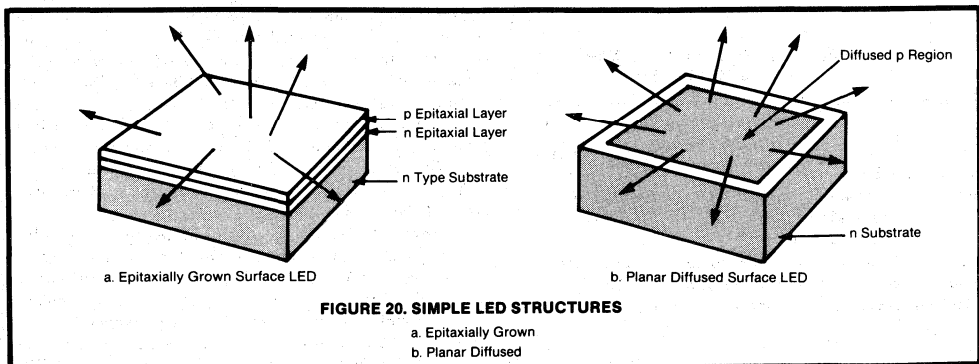

FIGURE 20. SIMPLE LED STRUCTURES

- a. Epitaxially Grown
- b. Planar Diffused

Figure 21 is a heterojunction aluminum-gallium-arsenide structure. The geometry is designed so that the device current is concentrated in a very small area of the active layer. This accomplishes several things: (1) the increase in current density makes for a brilliant light spot; (2) the small emitting area is well suited to coupling into small core fibers; and (3) the small effective area has a low capacitance and, thus, higher speed.

In Figure 21, the device appears to be nothing more than a multilayer version of the device in Figure 20a with a top metal layer containing a small opening. However, as the section view of AA shows in Figure 22, the internal construction provides some interesting features. To achieve concentration of the light emission in a small area, a method must be incorporated to confine the current to the desired area. Since the individual layers are grown across the entire surface of the wafer, a separate process must be used to confine the current. First an n-type tellurium-doped layer is grown on a zinc-doped p-type substrate. Before any additional layers are grown, a hole is etched through the n-layer and just into the substrate. The diameter of the hole defines the ultimate light-emitting area. Next, a p-type layer of AlGaAs is grown. This layer is doped such that its resistivity is quite high; this impedes carrier flow in a horizontal direction, but vertical flow is not impeded since the layer is so thin. This ensures that current flow from the substrate will be confined to the area of the etched hole. The next layer to be grown is the p-type active layer. The aluminum-gallium mix of this layer gives it an energy gap corresponding to 820 nm wavelength photons. The actual P-N junction is then formed by growth of n-type tellurium-doped aluminum-gallium-arsenide. The doping and aluminum-gallium mix of this layer is set to give it a larger energy gap than the p-layer just below it. This makes it essentially transparent to the 820 nm photons generated below. A final cap layer of gallium-arsenide is grown to enable ohmic contact by the top metal. The end result is an 820 nm planar LED of small emission area. The radiation pattern is still lambertian, however.

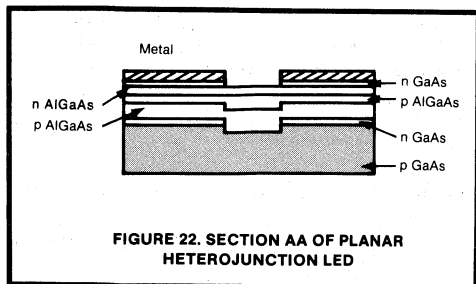

FIGURE 22. SECTION AA OF PLANAR HETEROJUNCTION LED

If a fiber with a core equal in area to the emission area is placed right down on the surface, it might seem that all the emitted light would be collected by the fiber; but since the emission pattern is lambertian, high order mode rays will not be launched into the fiber.

There is a way to increase the amount of light coupled. If a spherical lens is placed over the emitting area, the collimating effect will convert high order modes to low order modes (see Figure 23).

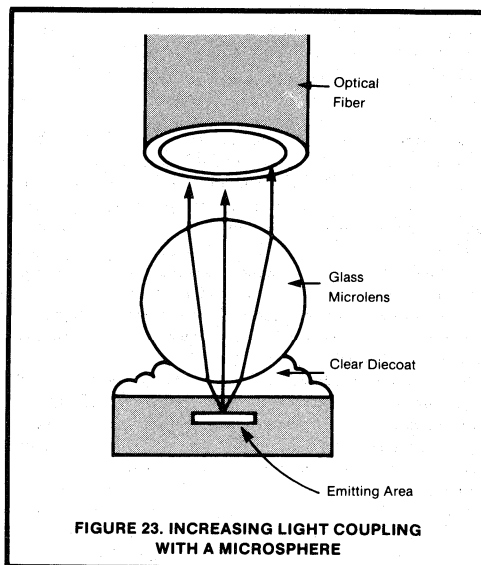
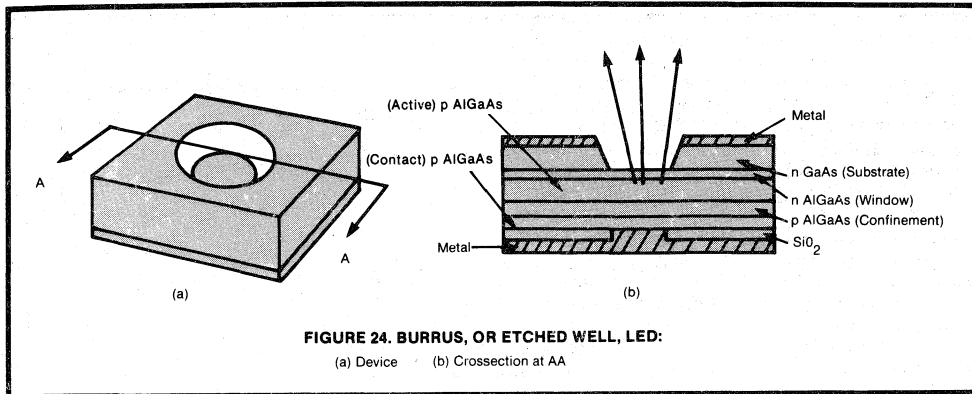

FIGURE 23. INCREASING LIGHT COUPLING WITH A MICROSPHERE

Etched-Well Surface LED

For data rates used in telecommunications (100 MHz), the planar LED becomes impractical. These higher data rates usually call for fibers with cores on the order of 50-62 μm . If a planar LED is used, the broad emission pattern of several hundred micro-meters will only allow a few percent of the power to be launched into the small fiber. Of course, the emission area of the planar device could be reduced; but this can lead to reliability problems. The increase in current density will cause a large temperature rise in the vicinity of the junction, and the thermal path from the junction to the die-attach header (through the confining layer and substrate) is not good enough to help draw the heat away from the junction. Continuous operation at higher temperature would soon increase the non-radiative sites in the LED and the efficiency would drop rapidly. If the chip is mounted upside down, the hot spot would be closer to the die-attach surface; but the light would have to pass through the thick substrate. The photon absorption in the substrate would reduce the output power significantly. A solution to this problem was developed by Burris and Dawson, of Bell Labs. The etched-well, or "Burrus" diode, is shown in Figure 24.

The thick n-type substrate is the starting wafer. Successive layers of aluminum-gallium-arsenide are grown epitaxially on the substrate. The layer functions (confinement, active, window) are essentially the same as in the planar structure. After the final p-type layer (contact) is grown, it is covered with a layer of SiO_2 . Small openings are then cut in the SiO_2 to define the active emitting area. Metal is then evaporated over the wafer and contacts the p-layer through the small openings. The final processing consists of etching through the substrate. The



etched wells are aligned over the active areas defined by the SiO₂ openings on the underside of the wafer and remove the heavily-photon-absorptive substrate down to the window layer. As an indication of the delicacy of this operation, it requires double-sided alignment on a wafer about 0.1 mm thick with a final thickness in the opening of about 0.025 mm.

The radiation pattern from the Burrus diode is still lambertian. However, it has a remarkably-small emitting area and enables coupling into very small fibers (down to 50 μm). The close proximity of the hot spot (0.005 mm) to the heat sink at the die attach makes it a reliable structure.

Several methods can be used for launching the emitted power into a fiber. These are shown in Figure 25.

The Burrus structure is superior to the planar for coupling to small fibers (<100 μm) but considerably more expensive due to its delicate structure.

Edge-Emitting LED

The surface structures discussed above are lambertian sources. A variation of the heterojunction family that emits a

more directional pattern is the edge-emitting diode. This is shown in Figure 26. The layer structure is similar to the planar and Burrus diodes, but the emitting area is a stripe rather than a confined circular area. The emitted light is taken from the edge of the active stripe and forms an elliptical beam. The edge-emitting diode is quite similar to the diode lasers used for fiber optics. Although the edge emitter provides a more efficient source for coupling into small fibers, its structure calls for significant differences in packaging from the planar or Burrus.

Photo Detectors

PIN Photodiodes. Just as a P-N junction can be used to generate light, it can also be used to detect light. If a P-N junction is reverse-biased and under dark conditions, very little current flows through it. However, when light shines on the device, photon energy is absorbed and hole-electron pairs are created. If the carriers are created in or near the depletion region at the junction, they are swept across the junction by the electric field. This movement of charge carriers across the junction causes a current flow in the circuitry external to the diode. The

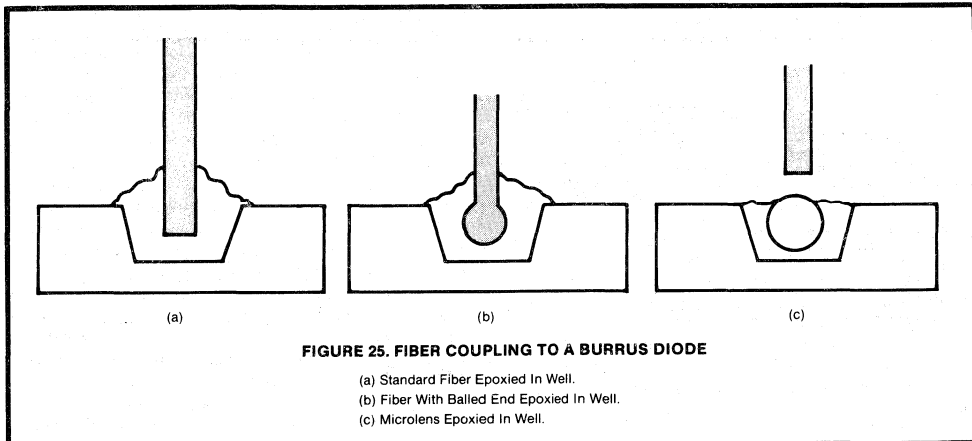

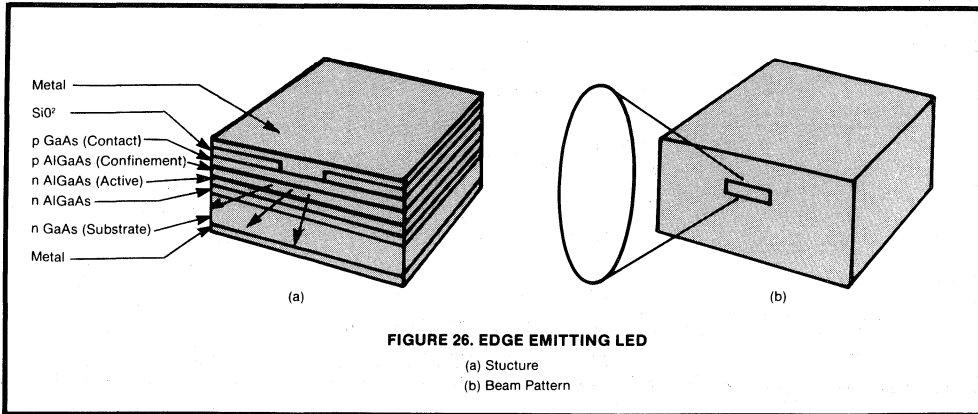

FIGURE 26. EDGE EMITTING LED

(a) Structure
(b) Beam Pattern

magnitude of this current is proportional to the light power absorbed by the diode and the wavelength. A typical photodiode structure is shown in Figure 27, and the IV characteristic and spectral sensitivity are given in Figure 28.

In Figure 28a, it is seen that under reverse-bias conditions, the current flow is a noticeable function of light power density on the device. Note that in the forward-bias mode, the device eventually acts like an ordinary forward-biased diode with an exponential IV characteristic.

Although this type of P-N photodiode could be used as a fiber optic detector, it exhibits three undesirable features. The noise performance is generally not good enough to allow its use in sensitive systems; it is usually not fast enough for high-speed data applications; and due to the depletion width, it is not sensitive enough. For example, consider Figure 29. The depletion is indicated by the plot of electric field. In a typical device, the p-anode is very heavily doped; and the bulk of the depletion region is on the n-cathode side of the junction. As light shines on the device, it will penetrate through the p-region toward the junction. If all the photon absorption takes place in the depletion region, the generated holes and electrons will be accelerated by the field and will be quickly converted to circuit current. However, hole-electron pair generation occurs from the surface to the back side of the device. Although most of it occurs within the depletion region, enough does occur outside this region to cause a problem in high-speed applications. This problem is illustrated in Figure 30. A step pulse of light is applied to a photodiode. Because of distributed capacitance and bulk resistance, an exponential response by the diode is expected. The photocurrent wave form shows this as a ramp at turn-on. However, there is a distinct tail that occurs starting at point "a." The initial ramp up to "a" is essentially the response within the depletion region. Carriers that are generated outside the depletion region are not subject to acceleration by the high electric field. They tend to move through the bulk by the process of diffusion, a much slower travel. Eventually, the carriers reach the depletion region and are sped up. The effect can be eliminated, or at least substantially reduced by using a PIN structure. This is shown in Figure 31, and the electric field distribution is shown in Figure 32. Almost the entire electric

tion region, the generated holes and electrons will be accelerated by the field and will be quickly converted to circuit current. However, hole-electron pair generation occurs from the surface to the back side of the device. Although most of it occurs within the depletion region, enough does occur outside this region to cause a problem in high-speed applications. This problem is illustrated in Figure 30. A step pulse of light is applied to a photodiode. Because of distributed capacitance and bulk resistance, an exponential response by the diode is expected. The photocurrent wave form shows this as a ramp at turn-on. However, there is a distinct tail that occurs starting at point "a." The initial ramp up to "a" is essentially the response within the depletion region. Carriers that are generated outside the depletion region are not subject to acceleration by the high electric field. They tend to move through the bulk by the process of diffusion, a much slower travel. Eventually, the carriers reach the depletion region and are sped up. The effect can be eliminated, or at least substantially reduced by using a PIN structure. This is shown in Figure 31, and the electric field distribution is shown in Figure 32. Almost the entire electric

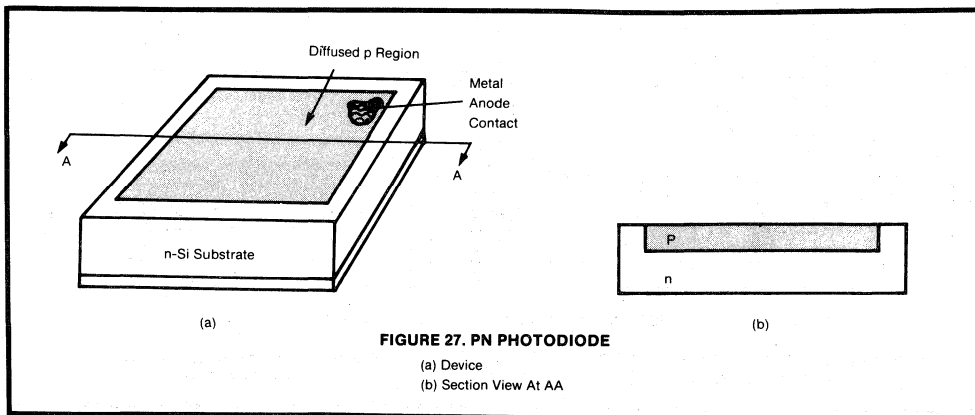
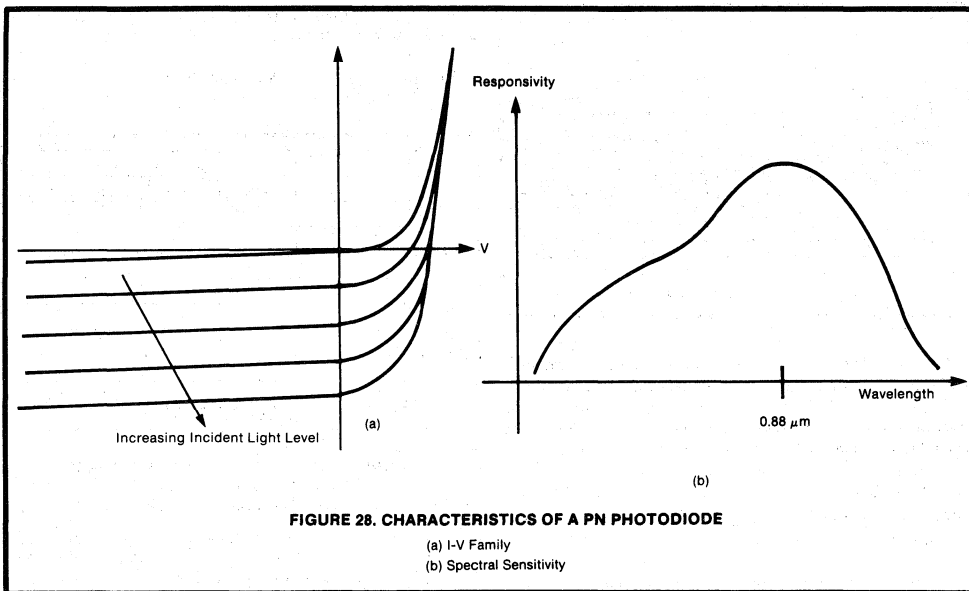

FIGURE 27. PN PHOTODIODE

(a) Device
(b) Section View At AA



field is across the intrinsic (I) region and very few photons are absorbed in the p- and n-region. The photocurrent response in such a structure is essentially free of the tailing effect seen in Figure 30.

In addition to the response time improvements, the high resistivity I-region gives the PIN diode lower noise performance.

The critical parameters for a PIN diode in a fiber optic application are:

1. Responsivity;
2. Dark current;
3. Response speed;
4. Spectral response.

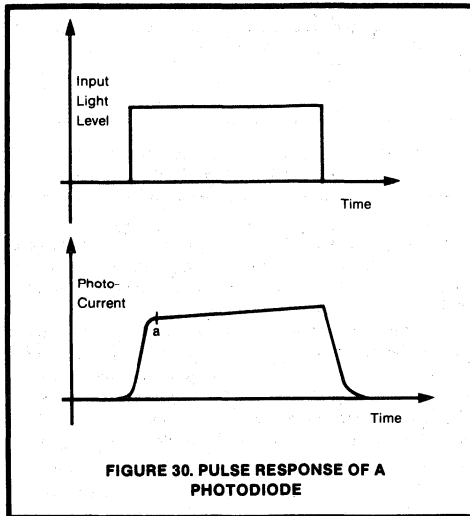
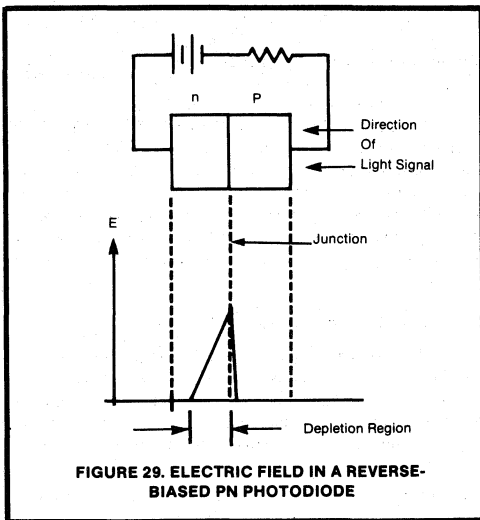

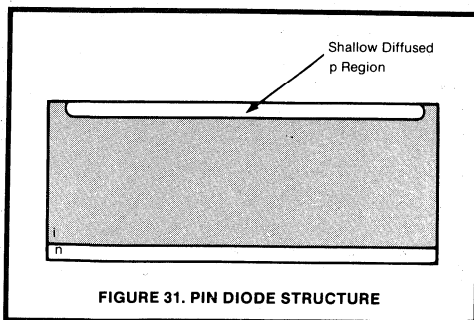

FIGURE 31. PIN DIODE STRUCTURE

Responsivity is usually given in amps/watt at a particular wavelength. It is a measure of the diode output current for a given power launched into the diode. In a system, the designer must then be able to calculate the power level coupled from the system to the diode (see AN-804, listed in Bibliography).

Dark current is the thermally-generated reverse leakage current in the diode. In conjunction with the signal current calculated from the responsivity and incident power, it gives the designer the on-off ratio to be expected in a system.

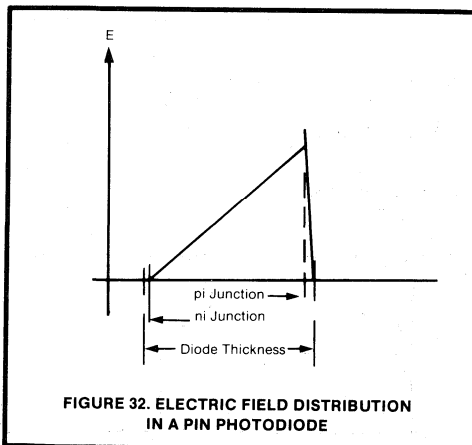

FIGURE 32. ELECTRIC FIELD DISTRIBUTION IN A PIN PHOTODIODE

Response Speed determines the maximum data rate capability of the diode; and in conjunction with the response of other elements of the system, it sets the maximum system data rate.⁵

Spectral Response determines the range, or system length, that can be achieved relative to the wavelength at which responsivity is characterized. For example, consider Figure 33. The responsivity of the MFOD102F is given as 0.15 A/W at 900 nm. As the curve indicates, the response at 900 nm is 78 percent of the peak response. If the diode is to be used in a

system with an LED operating at 820 nm, the response (or system length) would be:

$$R(820) = \frac{0.98}{0.78} R(900) = 1.26 R(900) = 0.19 \text{ A/W} \quad (13)$$

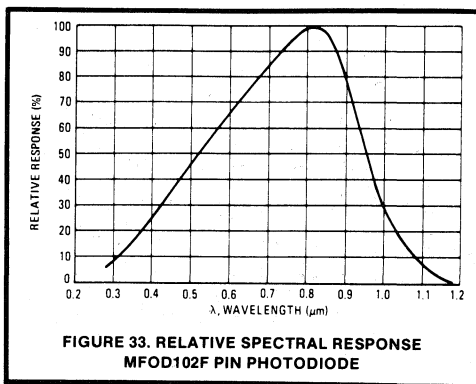

FIGURE 33. RELATIVE SPECTRAL RESPONSE MFOD102F PIN PHOTODIODE

Integrated Detector Preamplifiers. The PIN photodiode mentioned above is a high output impedance current source. The signal levels are usually on the order of tens of nanoamps to tens of microamps. The signal requires amplification to provide data at a usable level like T²L. In noisy environments, the noise-insensitive benefits of fiber optics can all be lost at the receiver connection between diode and amplifier. Proper shielding can prevent this. An alternative solution is to integrate the follow-up amplifier into the same package as the photo diode. This device is called an integrated detector preamplifier (IDP). An example of this is given in Figure 34.

Incorporating an intrinsic layer into the monolithic structure is not practical with present technology, so a P-N junction photodiode is used. The first two transistors form a transimpedance amplifier. A third stage emitter follower is used to provide resistive negative feedback. The amplifier gives a low impedance voltage output which is then fed to a phase splitter. The two outputs are coupled through emitter followers.

The MFOD404F IDP has a responsivity greater than 230 mV/μW at 820 nm. The response rise and fall times are 50 ns maximum, and the input light power can go as high as 30 μW before noticeable pulse distortion occurs. Both outputs offer a typical impedance of 200 Ω.

The IDP can be used directly with a voltage comparator or, for more sophisticated systems, could be used to drive any normal voltage amplifier. Direct drive of a comparator is shown in Figure 35.

A Fiber Optics Communication System

Now that the basic concepts and advantages of fiber optics and the active components used with them have been discussed, it is of interest to go through the design of a system. The system will be a simple point-to-point application operating in the simplex⁶ mode. The system will be analyzed for three aspects:

⁵Device capacitance also impacts this. See "Designer's Guide to Fiber-Optic Data Links" listed in Bibliography.

⁶In a simplex system, a single transmitter is connected to a single receiver by a single fiber. In a half duplex system, a single

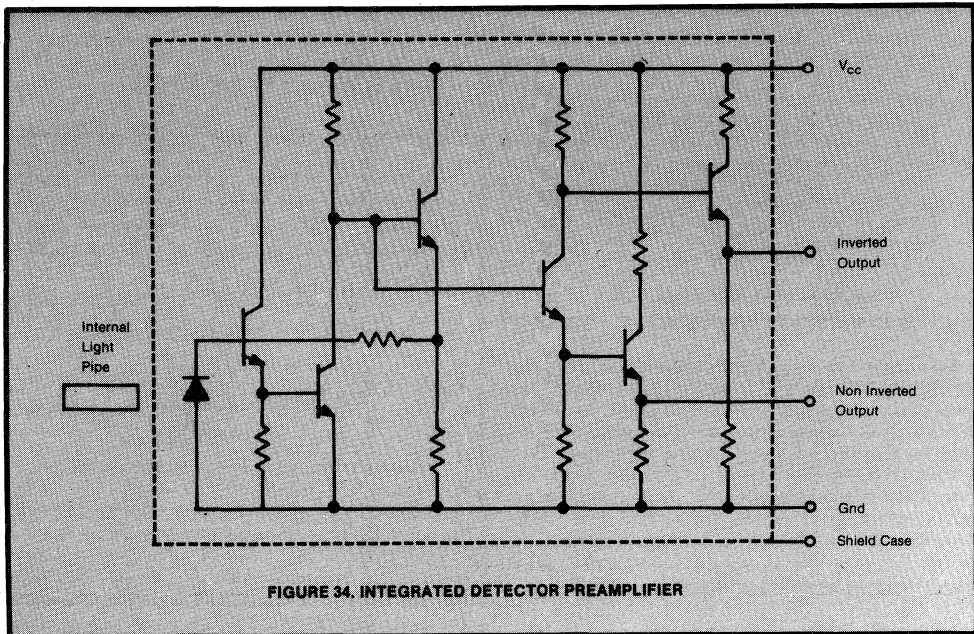

1. Loss budget;
2. Rise time budget;
3. Data encoding format.

Loss Budget. If no in-line repeaters are used, every element of the system between the LED and the detector introduces some loss into the system. By identifying and quantifying each loss, the designer can calculate the required transmitter power to ensure a given signal power at the receiver, or conversely, what signal power will be received for a given transmitter power. The process is referred to as calculating the system loss budget.

This sample system will be based on the following individual characteristics:

Transmitter: MFOE107F/108F, characteristics as in Figure 36.

Fiber: Silica-clad silica fiber with a core diameter of 200 μm ; step index multimode; 20 dB/km attenuation at 820 nm; N.A. of 0.35, and a 3.0 dB bandwidth of 5.0 MHz-km.

Receiver: MFOD404F, characteristics as in Figure 37.

The system will link a transmitter and receiver over a distance of 1000 meters and will use a single section of fiber (no splices).

⁶cont.

fiber provides a bidirectional alternate signal flow between a transmitter/receiver pair at each end. A full duplex system would consist of a transmitter and receiver at each end and a pair of fibers connecting them.

Some additional interconnect loss information is required.⁷

1. Whenever a signal is passed from an element with an N.A. greater than the N.A. of the receiving element, the loss incurred is given by:

$$\text{N.A. Loss} = 20 \log (\text{NA1}/\text{NA2}) \quad (14)$$

where; NA1 is the exit numerical aperture of the signal source;

where NA2 is the acceptance N.A. of the element receiving the signal.

2. Whenever a signal is passed from an element with a cross-sectional area greater than the area of the receiving element, the loss incurred is given by:

$$\text{Area Loss} = 20 \log (\text{Diameter 1}/\text{Diameter 2}) \quad (15)$$

where: Diameter 1 is the diameter of the signal source (assumes a circular fiber port);

where: Diameter 2 is the diameter of the element receiving the signal.

3. If there is any space between the sending and receiving elements, a loss is incurred. For example: an LED with an exit N.A. of 0.5 will result in a gap loss of 1.5 dB if it couples into a fiber over a gap of 0.15 mm.
4. If the source and receiving elements have their axes offset, there is an additional loss. This loss is also dependent on the separation gap. For an LED with an exit N.A. of 0.5, a gap with its receiving fiber of 0.15 mm, and an axial misalignment of 0.035 mm, there will be a combined loss of 1.8 dB.

⁷For a detailed discussion of all these loss mechanisms, see AN-804.

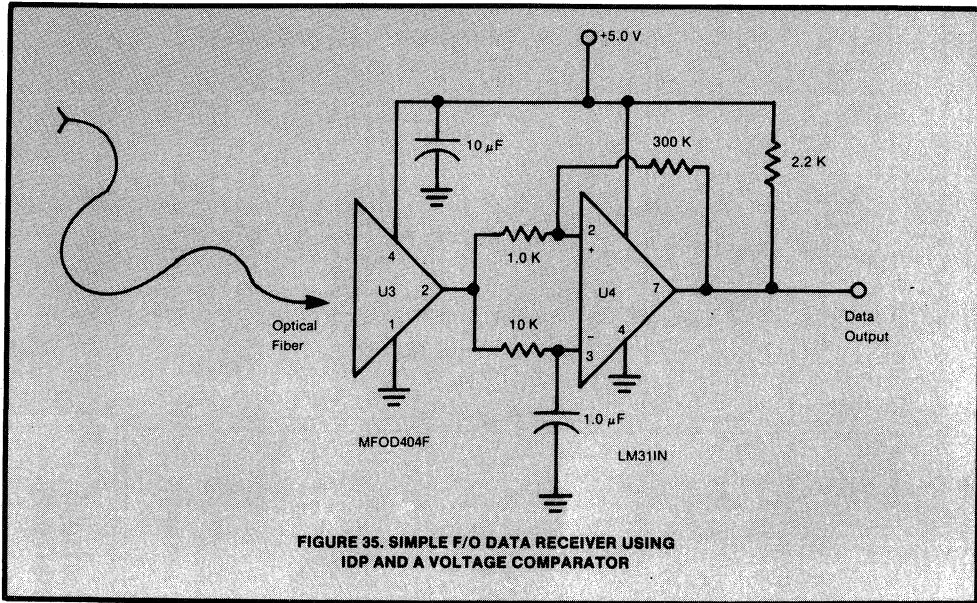

FIGURE 35. SIMPLE F/O DATA RECEIVER USING IDP AND A VOLTAGE COMPARATOR

5. If the end surfaces of the two elements are not parallel, an additional loss can be incurred. If the non-parallelism is held below 2-3 degrees, this loss is minimal and can generally be ignored.
6. As light passes through any interface, some of it is reflected. This loss, called Fresnel loss, is a function of the indices of refraction of the materials involved. For the devices in this example, this loss is typically 0.2 dB/interface.

The system loss budget is now ready to be calculated. Figure 38 shows the system configuration. Table II presents the individual loss contribution of each element in the link.

TABLE II
Fiber Optic Link Loss Budget

| | Loss Contribution |
|--|-------------------|
| MFOE107F to Fiber N.A. Loss | 3.10 dB |
| MFOE107F to Fiber Area Loss | 0 |
| Transmitter Gap and Misalignment Loss (see text) | 1.80 dB |
| Fiber Entry Fresnel Loss | 0.20 dB |
| Fiber Attenuation (1.0 km) | 20.00 dB |
| Fiber Exit Fresnel Loss | 0.20 dB |
| Receiver Gap and Misalignment Loss | 1.20 dB |
| Detector Fresnel Loss | 0.20 dB |
| Fiber to Detector N.A. Loss | 0 |
| Fiber to Detector Area Loss | 0 |
| Total Path Loss | 26.70 dB |

Note that in Table II no Fresnel loss was considered for the LED. This loss, although present, is included in specifying the

output power in the data sheet.

In this system, the LED is operated at 100 mA. Figure 36 shows that at this current the instantaneous output power is typically 1100 μW. This assumes that the junction temperature is maintained at 25°C. The output power from the LED is then converted to a reference level relative to 1.0 mW:

$$P_o = 10 \log \frac{1.1 \text{ mW}}{1.0 \text{ mW}} \quad (16)$$

$$P_o = 0.41 \text{ dBm} \quad (17)$$

The power received by the MFOD404F is then calculated:

$$P_R = P_o - \text{loss} \quad (18)$$

$$= 0.41 - 26.70 \quad (19)$$

$$= -26.29 \text{ dBm}$$

This reference level is now converted back to absolute power:

$$P_R = 10^{(-26.29)/10} \text{ mW} = 0.0024 \text{ mW} \quad (20)$$

Based on the typical responsivity of the MFOD404F from Figure 37, the expected output signal will be:

$$V_o = 35 \text{ mV}/\mu\text{W} (2.4 \mu\text{W}) = 84 \text{ mV} \quad (21)$$

As shown in Figure 37, the output signal will be typically two hundred times above the noise level.

In many cases, a typical calculation is insufficient. To perform a worst-case analysis, assume that the signal-to-noise ratio at the MFOD404F output must be 20 dB. Figure 37 shows the maximum noise output voltage is 1.0 mV. Therefore, the output signal must be 10 mV. With a worst-case responsivity of 20 mV/μW, the received power must be:

$$P_R = \frac{V_o}{R} = \frac{10 \text{ mV}}{23 \text{ mV}/\mu\text{W}} = 0.43 \mu\text{W} \quad (22)$$

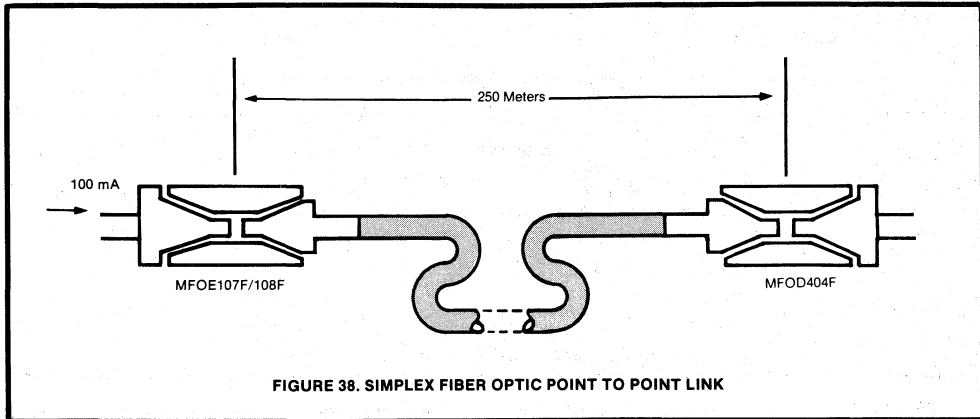

FIGURE 38. SIMPLEX FIBER OPTIC POINT TO POINT LINK

$$P_R = 10 \log \frac{0.00043 \text{ mW}}{1.0 \text{ mW}} = -34 \text{ dBm} \quad (23)$$

It is advisable to allow for LED degradation over time. A good design may include 3.0 dB in the loss budget for long-term degradation.

The link loss was already performed as worst case, so:

$$P_O (\text{LED}) = -34 \text{ dBm} + 3.0 \text{ dB} + 20.62 \text{ dB} = -4.38 \text{ dBm} \quad (24)$$

$$P_O = 10^{(-4.38)} \text{ mW} = 0.365 \text{ mW} = 365 \mu\text{W} \quad (25)$$

Based on the Power Output versus Forward Current curve in Figure 36, it can be seen that the drive current (instantaneous forward current) necessary for 365 μW of power is about 30 mA.

Figure 36 also includes a Power Output versus Junction Temperature curve which, when used in conjunction with the thermal resistance of the package enables the designer to allow for higher drive currents as well as variations in ambient temperatures.

At 30 mA drive, the forward voltage will be less than 2.0 V worst case. Using 2.0 V will give a conservative analysis:

$$P_D = (30 \text{ mA})(2.0 \text{ V}) = 60 \text{ mW} \quad (26)$$

This is well within the maximum rating for operation at 25°C ambient. If we assume the ambient will be 25°C or less, the junction temperature can be conservatively calculated. Installed in a compatible metal connector:

$$\Delta T_J = (175^\circ\text{C/W})(0.06 \text{ W}) = 11^\circ\text{C} \quad (27)$$

If we are transmitting digital data, we can assume an average duty cycle of 50% so the ΔT_J will likely be less than 6°C. This gives:

$$T_J = T_A + \Delta T_J = 32^\circ\text{C} \quad (28)$$

The power output derating curve shows a value of 0.9 at 32°C. Thus the required dc power level needs to be:

$$P_O (\text{dc}) = \frac{365}{0.9} = 406 \mu\text{W} \quad (29)$$

As Figure 36 indicates, increasing the drive current to 40 mA would provide greater than 500 μW power output and only increase the junction temperature 1°C. This analysis shows the

link to be more than adequate under the worst case conditions.

Rise Time Budget. The cable for this system was specified to have a bandwidth of 5.0 MHz-km. Since the length of the system is 1.0 km, the system bandwidth, if limited by the cable, is 5.0 MHz. Data links are usually rated in terms of a rise time budget. The system rise time is found by taking the square root of the sum of the squares of the individual elements. In this system the only two elements to consider are the LED and the detector. Thus:

$$t_{R_S} = \sqrt{(t_{R-\text{LED}})^2 + (t_{R-\text{detector}})^2} \quad (30)$$

Using the typical values from Figures 36 and 37:

$$t_{R_S} = \sqrt{(15)^2 + (35)^2} = 38 \text{ ns} \quad (31)$$

Total system performance may be impacted by including the rise time of additional circuit elements. Additional considerations are covered in detail in AN-794 and the Designer's Guide mentioned earlier (see Bibliography).

Data Encoding Format. In a typical digital system, the coding format is usually NRZ, or non-return to zero. In this format, a string of ones would be encoded as a continuous high level. Only when there is a change of state to a "0" would the signal level drop to zero. In RTZ (return to zero) encoding, the first half of a clock cycle would be high for a "1" and low for a "0." The second half would be low in either case. Figure 39 shows an NRZ and RTZ waveform for a binary data stream. Note between a-b the RTZ pulse rate repetition rate is at its highest. The highest bit rate requirement for an RTZ system is a string of "1's". The highest bit rate for an NRZ system is for alternating "1's" and "0's," as shown from b-c. Note that the highest NRZ bit rate is half the highest RTZ bit rate, or an RTZ system would require twice the bandwidth of an NRZ system for the same data rate.

However, to minimize drift in a receiver, it will probably be ac coupled; but if NRZ encoding is used and a long string of "1's" is transmitted, the ac coupling will result in lost data in the receiver. With RTZ data, data is not lost with ac coupling since only a string of "0's" results in a constant signal level; but that level is itself zero. However, in the case of both NRZ and RTZ, any continuous string of either "1's" or "0's" for NRZ or

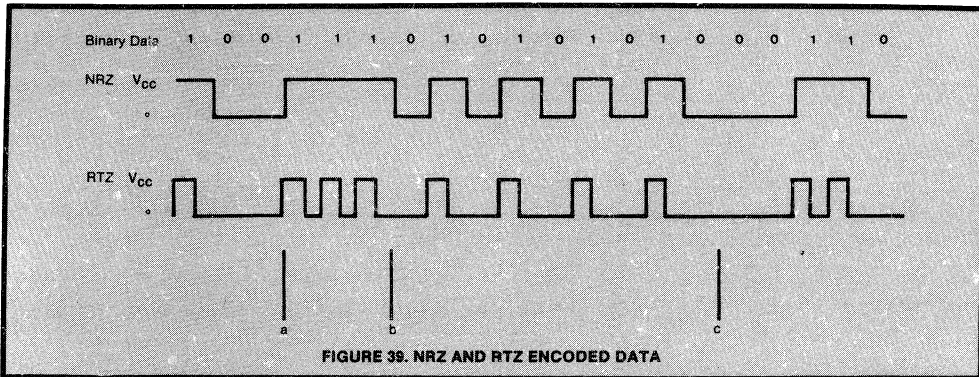

or "0's" for RTZ will prevent the receiver from recovering any clock signal.

Another format, called Manchester encoding, solves this problem, by definition, in Manchester, the polarity reverses once each bit period regardless of the data. This is shown in Figure 40. The large number of level transitions enables the receiver to derive a clock signal even if all "1's" or all "0's" are being received.

In many cases, clock recovery is not required. It might appear that RTZ would be a good encoding scheme for these applications. However, many receivers include automatic gain control (AGC). During a long stream of "0's", the AGC could crank the receiver gain up; and when "1's" data begin to appear, the receiver may saturate. A good encoding scheme for these applications is pulse bipolar encoding. This is shown in Figure 41. The transmitter runs at a quiescent level and is turned on

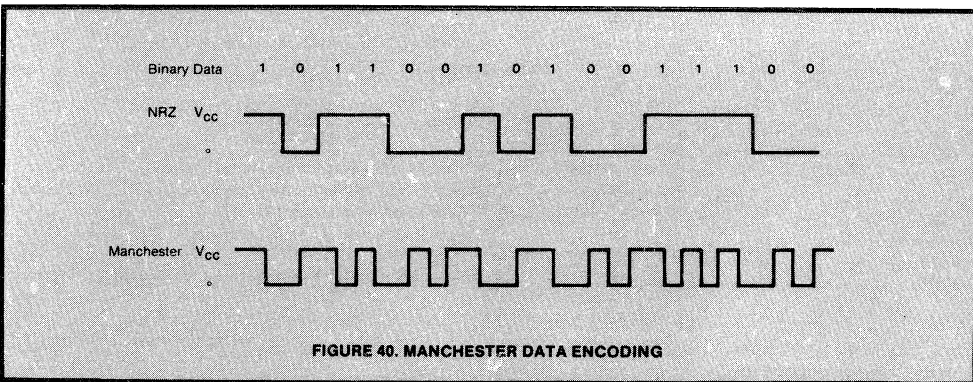

harder for a short duration during a data "0" and is turned off for a short duration during a data "1."

Additional details on encoding schemes can be obtained from recent texts on data communications or pulse code modulation.

Summary

This note has presented the basic principles that govern the coupling and transmission of light over optical fibers and the design considerations and advantages of using optical fibers for communication information in the form of modulated light.

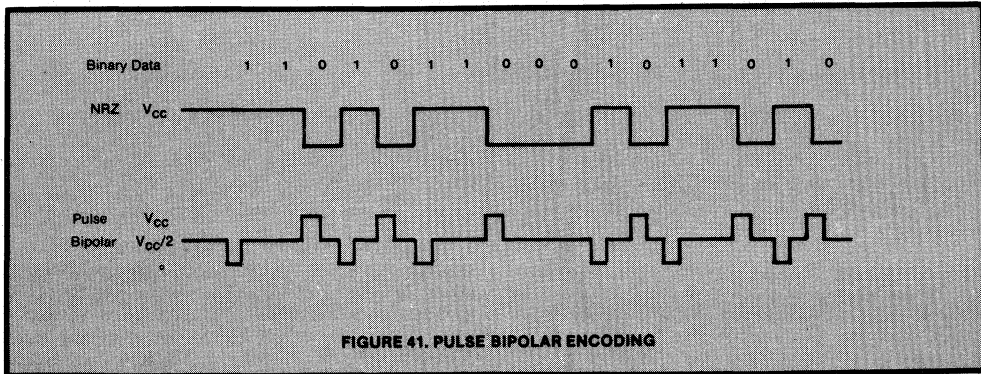

Bibliography

1. Gempe, Horst; "Applications of Ferruled Components to Fiber Optic Systems," Motorola Application Note AN-804; Phoenix, Arizona; 1980.
2. Mirtich, Vincent L.; "A 20-M Baud Full Duplex Fiber Optic Data Link Using Fiber Optic Active Components." Motorola Application Note AN-794; Phoenix, Arizona, 1980.
3. Mirtich, Vincent L.; "Designer's Guide to: Fiber-Optic Data Links." Parts 1, 2, & 3; EDN June 20, 1980; August 5, 1980; and August 20, 1980.

Application of the Motorola VDE Approved Optocouplers

Prepared By Horst Gempe

The VDE approval of the Motorola Optocoupler Family is of great importance since VDE follows the widespread safety recommendations of the International Electrotechnical Commission (IEC) which is accepted and adopted by many countries throughout Europe and the world. The intent of these safety standards is to prevent injury or damage due to electrical shock, fire, energy — mechanical — heat — radiation and chemical hazards. The IEC recommendations provide an ever increasing unifying control over most national standards worldwide. The US and Canada have similar standards and there is a trend to harmonize their standards with the IEC recommendations. This short application note is able to mention only some VDE/IEC equipment safety standards the primary objective of which is to enable designers to realize safety requirements at an early design stage and build them into the equipment while incorporating the relevant requirements of these standards.

VDE approval of optoisolators against the VDE component standard VDE0883 can be quite misleading if the user is not informed about the optoisolator's rating, or if this rating does not meet the individual equipment stan-

dard for which this VDE approved optocoupler is intended to be used.

VDE0883 does not dictate a minimum required performance, clearance, creepage path or thickness through insulation but instead gives test methods, types and sequence of tests which have to be performed. An exception is the isolation resistance which has to be 10^{11} ohms minimum at 500 Vdc and a 16 hr. 70°C heat storage @ 700 V VISO BIAS. (See Table 1.) Obviously, the manufacturer of the component must indicate to VDE against what ratings he wants to be approved. Ideally these ratings should meet or exceed all existing VDE equipment standard requirements. (See Table 2.) A wide range of equipment standards is covered by the VDE approved Motorola optoisolators. (See Table 3.) In this approval, VDE granted Motorola compliance with many equipment standards to avoid confusion by the user of this product. A copy of the original VDE approval NR41853 File No. 12505-4880-1003/A1F (11/26/1985) with ratings and conformation to VDE and IEC equipment standards may be obtained from Motorola.

VDE RATINGS — For Motorola VDE approved 6-pin DIP Optoisolators approval No. 4183 (11/26/1985)

| Rating | Symbol | Value | Unit |
|--|----------------|---|------------|
| Ambient Operating Temperature Range | T_A | -55 to +100 | °C |
| Storage Temperature Range | T_{stg} | -55 to +150 | °C |
| Climatic Test Class | | 55/100/21 | |
| DC Isolation Voltage at 100°C for 1 Minute | $V_{ISO(pk)}$ | 5300 | kVdc |
| Nominal Operating Isolation Voltage for Isolation Group C According to VDE0110B | $V_{ISO(nom)}$ | 500 600 | Vac Vdc |
| Isolation Creepage Path (Figures 1 A, BC Appendix) | LICP | 8.5 Min | mm |
| Isolation Clearance (Figure 2 Appendix) STD Lead Bend Special Lead Bend | LICL | 8.3 Min 10 Min | mm mm |
| Isolation Resistance @ V_{ISO} 500 Vdc, $T_A = 100^\circ\text{C}$ | RISO | 10^{11} | Ω |
| Internal Thickness Through Insulation | — | 0.5 Min | mm |
| Creepage Current Stability of Insulation According to VDE303 Part 1/10.76, IEC 112 | Overmold | KC, KB100 Min | — |
| Surge Isolation Voltage According to IEC65 or VDE0860/8.81 | | 50 Discharges of 10 kV charged 1 nF 12 Discharges Max at 1 Minute | |

Table 1. VDE0883 Qualification Test

- Visual inspection
- Isolation withstand voltage (per applicants information)
- Parameter test (per applicants data sheet)
- Creepage path and clearance (measured)
- Isolation resistance (10^{11} ohms @ 500 Vdc min.)
- Resistance to solder heat @ 260°C, 5 sec.

Environmental Tests

- | | |
|---|--|
| <p>Group I 28 samples</p> <ul style="list-style-type: none"> • 5 temp. cycles per applicants specified storage temp. extremes • 16 hr. heat storage @ 70°C, 700 Vdc • 12 hr. humid heat @ 25°C, 95% RH • 12 hr. cold storage @ applicants specified max low storage temp. • 5 cycles humid heat @ 40°C, 90% RH dwell 12 hrs. @ 25°C, 95% RH dwell 12 hrs. • 6 hr. dry cycle @ 55°C | <p>Group II 14 samples</p> <ul style="list-style-type: none"> • 21 day humid heat const. 40°C, 95% • 6 hr. dry @ 55°C • 90 min. vibration 50-2 kHz 10G |
|---|--|

End test: • functional per applicant's data sheet

- Isolation withstand voltage
- Isolation resistance min. 10^{11} ohms @ 500 Vdc

Pass: 0 failure/42

CIRCUIT BOARD LAYOUT DESIGN RULES

The most demanding and stringent safety requirements are on interfaces between a safety low-voltage circuit [SELV] and a hazardous voltage (240 V power line). The requirements for creepage path and clearance dimensioning are different for each individual equipment norm and also depend on the isolation group and safety class of the equipment and the circuit board's resistance to tracking. Isolation materials are classified for their resistance to tracking creepage current stability from KB 100 to $KB \leq 600$ (see VDE 303). On circuit board materials with a low KB value, the creepage path distance requirements are higher than for materials with a high KB value. In the following examples we therefore show creepage path dimensions for KB 100, the lowest value which is easily met by most circuit board materials.

The least stringent requirements on optocouplers, as well as printboard layouts, are within and in between SELV or ELV loops or circuits. (ELV = Electrical Low Voltage which does not meet the safety low voltage requirements.)

In studying the individual equipment norms, the designer will discover that optocouplers are not mentioned in most of these norms. He has to use the requirements for transformers or potted components instead.

Spacing requirements between two live tracks on a PC board within a low or high voltage loop (circuit) should generally meet the VDE requirements for minimum clearance and creepage path dimensions. If they do not, the circuit has to show some sort of current limiting (fuse, high-impedance, etc.) which prevents fire hazard due to an eventual short or sparkover between the two tracks. The VDE testing institute will conduct, in this case, a shorting test and a tracking test (arcing). See VDE 804. Classical cases are rectifiers, thyristors and high-voltage transistors which, sometimes due to their close pinout, might not meet the VDE equipment requirements at a certain voltage.

Table 2. Environmental Test

| Environment Test Per VDE0883 | Kind of Test | Application | Condition | Duration |
|---|--------------|----------------------|-----------------------|-------------------------------|
| Solderability Per DIN 40046 Part 18 or IEC 68-2-20 | Ta1 | Solder Bath | 260°C | 5 ± 1 sec |
| | Tb1 | Solder Iron 3 mm TIP | 260°C | 5 ± 1 sec |
| Temperature Cycling Per DIN 40046 Part 14 or IEC 68-2-18 | Na | 5 Cycles | -55°C/ +100°C | Dwell 3 Hrs Transfer 3 Min |
| Dry Heat Per DIN 40046 Part 4 or IEC 68-2-2 | Ba | $V_{ISO} = 700$ Vdc | 100°C | 16 Hrs |
| Humid Heat Cycling Per DIN 40046 Part 31 or IEC 68-2-30 | Db | 6 Cycles | 25°C/40°C RH 95% | Dwell 6 Hrs |
| Cold Per DIN 40046 Part 3 or IEC 68-2-1 | Aa | | -55°C | 16 Hrs |
| Humid Heat (Long Term) Per DIN 40046 Part 5 or IEC 68-2-3 | Ca | | 40°C RH 95% | 21 Days |
| Vibration Per DIN 40046 Part 8 or IEC 68-2-6 | Fc | | 55 Hz — 2 kHz 10 g | 90 Min |



Table 3. Examples for Safety Applications for Motorola VDE Approved Optoisolators

| Standard(2) | | Equipment | Requirements for reinforced (double) or save insulation for equipment with an operating voltage up to 250 Vrms (line voltage to ELV or SELV interfaces) | | | | |
|---------------------------------------|---------|---|---|--------------------------|-------------------|---------------------|----------------------|
| VDE | DIN IEC | | Creepage | Clearance (1) | Isolation Barrier | Dielectric Strength | Isolation Resistance |
| | | | [mm] | [mm] | [mm] | [kVrms] | [Ω] |
| 0806 | 380 | Office Machines | 8 | 8 | 0.5 | 3.75 | 7×10^6 |
| 0805 | 435 | Data Processing | 8 | 8 | — | 3.75 | 7×10^6 |
| 0804 | — | Telecommunication | 8 | 8 | — | 2.50 | 2×10^6 |
| 0860 | 65 | Electr. Household | 6 | 6 | 0.4 | 3.0 (10*) | 4×10^6 |
| 0113 | 204 | Industrial Controls | 8 | 8 | — | 2.50 | 1×10^6 |
| 0160 | — | Power Installations with Electronic Equipment | 8 | 8 | — | 2.70 | 1×10^6 |
| 0832 | — | Traffic Light Controls | 8 | 8 | — | 2.50 | 4×10^6 |
| 0883 | — | Alarm Systems | 8 | 8 | — | 2.50 | 2×10^6 |
| 0831 | — | EI. Signal Syst. for Railroads | 8 | 8 | — | 2.0 | 2×10^6 |
| 0110 | — | General Std. for Electrical Equipment | 8 | 8 | — | 2.0 | — |
| 0883 | — | Optisolator Comp. Std. | 8.5 | 8.3 (10 ⁽¹⁾) | 0.5 | 3.75 (10*) | 10×10^{11} |
| VDE Rating for Motorola Optoisolators | | | | | | | |

All Motorola VDE approved optoisolators meet or exceed the requirements of above listed VDE and IEC standards.

* Impulse discharge withstand voltage

(1) To satisfy 8 mm creepage path on a PC board Motorola offers a special lead bend of 0.4 inch on all 6-pin dual-in-line optoisolators. Order by attaching "T" to the end of the Motorola part number.

(2) VDE standards (translated into English language) and IEC standards can be ordered from the American National Standard Institute ANSI 1430 Broadway N.Y. N.Y. 10018, Sales Dept. Phone 212-354-3300.

Figure 1.

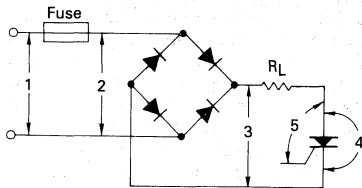

- 1 — Clearance and creepage path **must** meet min requirements*
 - 2 — Current limited due to fuse
 - 3, 4 — Current limited due to R_L and fuse
 - 5 — Current limited due to I_{GT} , R_L and fuse
- 2, 3, 4, 5 — Clearance and creepage path may be smaller than VDE min requirements but **must** meet fire hazard requirements due to short and arcing between the tracks. There shall be no flames or explosion during the test.

Figure 2.

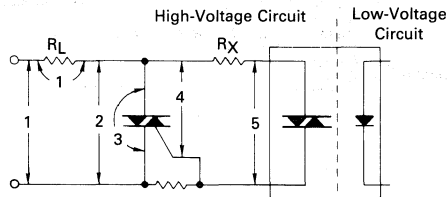

- 1 Clearance and creepage path **must** meet min requirements*
- 2 Current limited due to R_L
- 3 Current limited due to R_L
- 4 Current limited due to I_{GT}
- 5 Current limited due to I_{GT} and R_X

*See Table 3 and Appendix Table 4 and 5 for minimum spacings and voltage requirements.

PRINTED CIRCUIT BOARD LAYOUT FOR SELV-POWER INTERFACES

The circuit board layout examples shown here are dimensioned so that they provide a safe electrical isolation between metal parts carrying line voltage (called Power Interface) and conductors connected to a SELV circuit.

The required thickness through insulation for the optocoupler can be found in the individual VDE equipment norms. (See examples for safety applications, Table 3.)

Many Class I equipment norms permit the use of parts (modules, PC boards) which meet the Safety Class II

dimension and isolation requirements. This enables the designer to take advantage of the less complex and space demanding design of the Class II PC board layout also in Class I classified equipment.

Optocoupler Mounting on PC Boards for Safety Class I

SELV transformers for Class I equipment have a Faraday shield which is connected to earth ground between primary and secondary windings. This is **not** applicable to optocouplers, but creepage path and clearance requirements from safety Class II can be applied. Class I also demands an earth ground track on the circuit board

between SELV — and power circuit. Applying the Class I rules, this earth ground track should be between the coupler input and output. However, this cannot be done without violating the minimum creepage path and clearance requirements. A possible solution is shown on Figure 9 and Figure 10.

The earth ground track itself has to show a minimum distance to the equipment body (i.e., frame, circuit board enclosure) or to any inactive, active or hazardous track on the circuit board. According to many VDE equipment norms, this creepage path distance for 250 V Max is 4 mm. A mechanically unsecured circuit board which can be plugged in and out without a tool and is electrically connected through a standard PC board connector, has

to show an isolation of the earth ground track to Class II, which is 8 mm. This is because a standard PC connector, as shown in Figure 9, does not guarantee earthing contact **before** there is termination of the live 220 V tracks on the circuit board when plugged in. Another reason for increased spacing is when the circuit board metal enclosure is not securely earth grounded. This is the case when the connection is done with the PC module mounting screws through lacquer or oxide layers to a grounded rack or frame. (See Figure 10.) PC board designs per Figures 9 and 10 account for these possibilities and, therefore, show dimensions M, N and A, B and D as 8 mm instead of 4 mm.

Figure 3. Optocoupler Mounting on PC Boards for Safety Class II with Creepage Path and Clearance

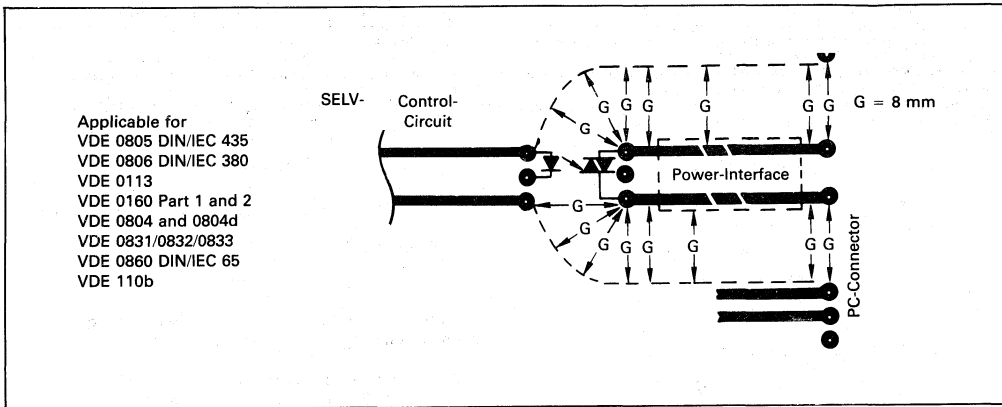
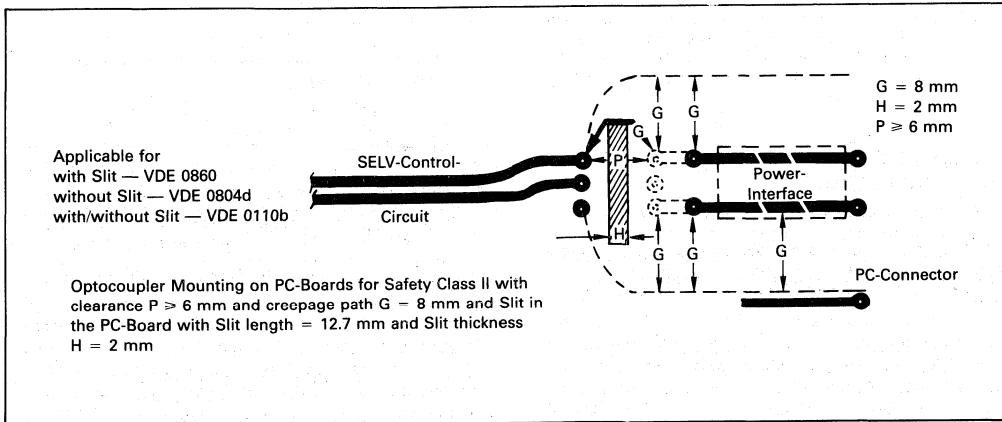
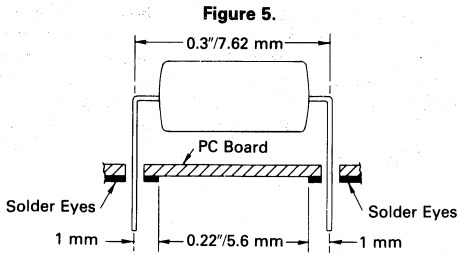

Figure 4. Optocoupler Mounting on PC Boards for Safety Class II with Clearance



COUPLER MOUNTING ON A CIRCUIT BOARD

Clearance and Creepage Path Between Input and Output for Optocouplers on a PC Board



Input/Output Leads — $L = 0.3"/7.62 \text{ mm}$
 Clearance Limited Due to PC Board
 Solder Eyes — $0.22"/5.6 \text{ mm}$
 Creepage Path on PC Board — $0.22"/5.6 \text{ mm}$

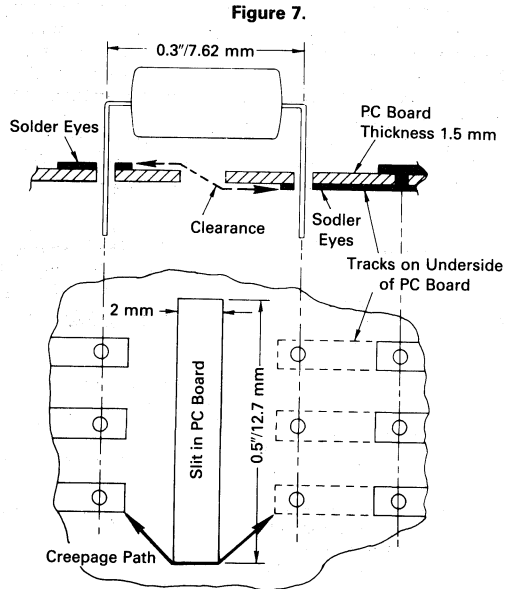

If a clearance of $0.23"/6 \text{ mm}$ and a creepage path of minimum 8 mm is required, this is a possible solution.

Slit — $0.5"/12.7 \text{ mm}$ long, 2 mm wide
 PC Board Thickness — 1.5 mm
 Clearance — 6 mm Min
 Creepage Path — 8 mm Min

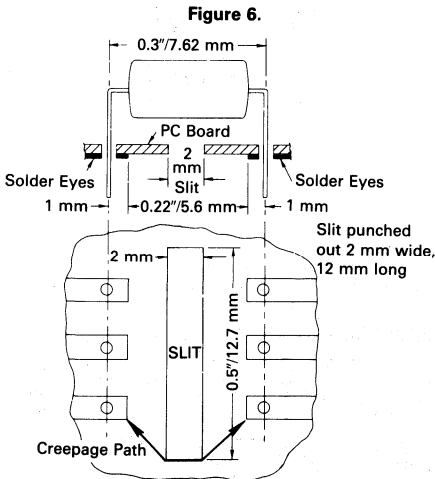

VDE equipment norms demanding longer creepage path than $0.22"/5.6 \text{ mm}$ can be accomplished by a slit in the PC board between the coupler input and output solder eyes of 2 mm width.

Input/Output Leads — $L = 0.3"/7.62 \text{ mm}$
 Clearance on PC Boards — $0.22"/5.6 \text{ mm}$ Min
 Creepage Path on PC Board — $0.31"/8 \text{ mm}$ Min

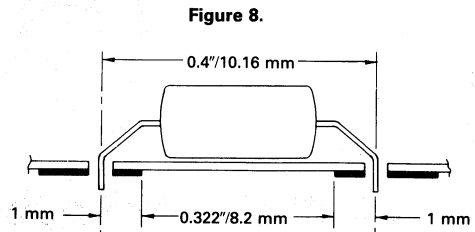

Where the equipment norms demand a clearance and creepage path of 8 mm Min, the coupler input and output leads should be bent to $0.4"/10.16 \text{ mm}$ and the printboard layout should be as shown.

Safety Coupler Mounting with Spacing — $L = 0.4"/10.16 \text{ mm}$
 Clearance on PC Board — $0.322"/8.2 \text{ mm}$
 Creepage Path on PC Board — $0.322"/8.2 \text{ mm}$

All Motorola 6-pin dual-in-line optoisolators are available in 0.400" lead form. Attach "T" to any Motorola 6-pin dual-in-line part number, for wide-spaced 0.400" lead form.

AN978

**Figure 9. Optocoupler Mounting on PC Board
According to Safety Class I with Only One PC
Board Plug Connection**

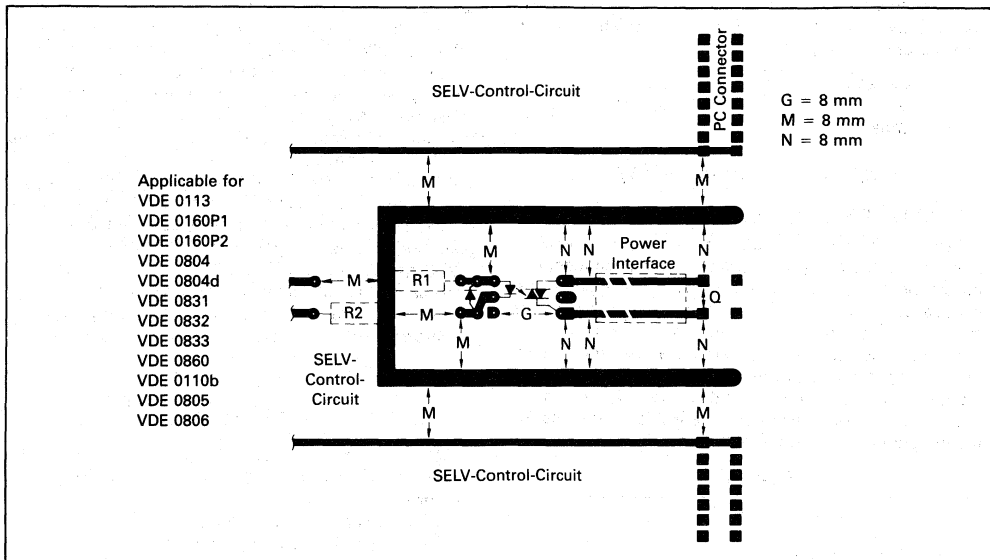

**Figure 10. Optocoupler Mounting on PC Board
According to Safety Class I with One Plug-
Connection for the SELV-Control Circuit and
One Screw-Connection for the Power-Interface**

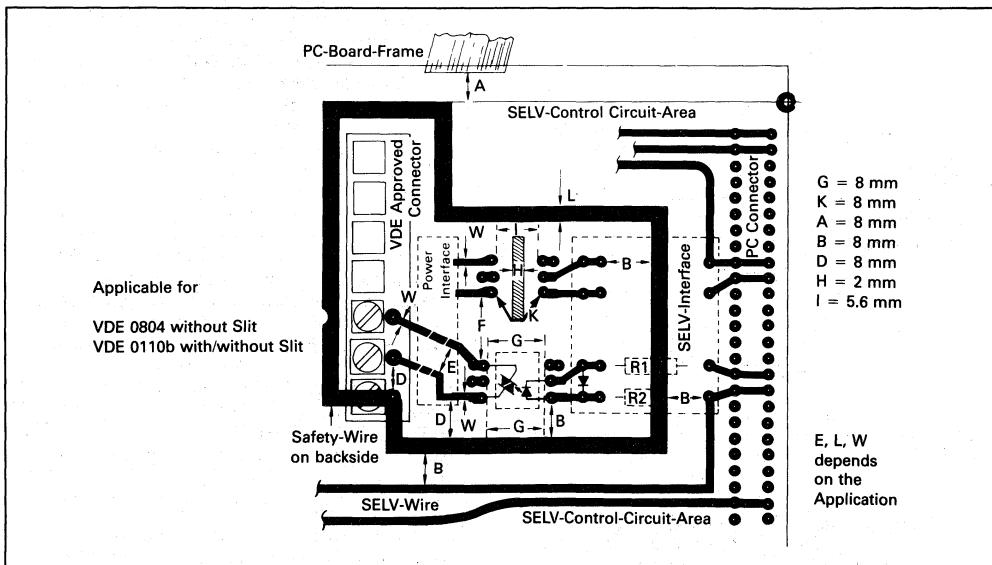

DEFINITION OF TERMS

The following paragraphs define terms used by the regulatory and international standard initiators. A separate discussion is given for:

1. Creepage and Clearance
2. Voltage
3. Insulations
4. Circuits
5. Equipment

1. CREEPAGE AND CLEARANCE

ISOLATION CREEPAGE PATH

Denotes the shortest path between two conductive parts measured along the surface of the insulation, i.e., on the optocouplers, it is the shortest distance on the surface of the package between the input and output leads. On the circuit board in which the coupler is mounted, it is the shortest distance across the surface of the board between the solder eyes of the coupler input/output leads. Coupler and circuit board creepage path have to meet the minimum specified distances for the individual VDE equipment norms.

Figure 11.

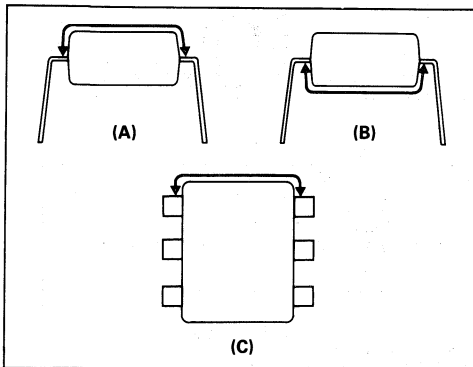

CLEARANCE

Denotes the shortest distance between two conductive parts or between a conductive part and the bonding surface of the equipment, measured through air.

Figure 12.

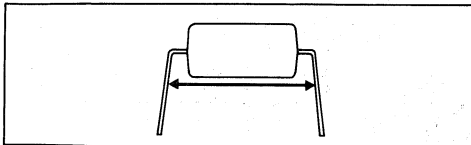

2. VOLTAGES

HAZARDOUS VOLTAGE: A voltage exceeding 42.4 V peak or dc, existing in a circuit which does not meet the requirements for a limited current circuit.

WORKING VOLTAGE shall be the voltage which exists across the insulation under normal working conditions. Where the rms value is used, a sinusoidal ac waveform shall be assumed. Where the dc value is used, the peak value of any superimposed ripple shall be considered.

EXTRA-LOW VOLTAGE (ELV): A voltage between conductors or between a conductor and earth not exceeding 42.4 V peak or dc, existing in a secondary circuit which is separated from hazardous voltages by at least basic insulation, but which does not meet the requirements for a SELV circuit nor those for a limited current circuit.

ISOLATION WITHSTAND VOLTAGE: An ac or dc test voltage insulation has to withstand without breakdown or damage. It should not be confused with working or operating voltage.

ISOLATION SURGE VOLTAGE: A positive or negative transient voltage of defined energy and rise and fall times which the insulation has to withstand without breakdown or damage.

3. INSULATIONS

INSULATION, OPERATIONAL (functional): Insulation which is necessary for the correct operation of the equipment.

- Between parts of different potential.
- Between ELV or SELV circuits and earthed conductive parts.

INSULATION, BASIC: Insulation to provide basic protection against electric shock.

- Between a part at hazardous voltage and an earthed conductive part.
- Between a part at hazardous voltage and a SELV circuit which relies on being earthed for its integrity.
- Between a primary power conductor and the earthed screen or core of a primary power transformer.
- As an element of double insulation.

INSULATION, SUPPLEMENTARY: Independent insulation applied in addition to basic insulation in order to ensure protection against electric shock in the event of a failure of the basic insulation.

- Between an accessible conductive part and a part which could assume a hazardous voltage in the event of a failure of basic insulation.
- Between the outer surface of handles, knobs, grips and the like, and their shafts unless earthed.
- Between a floating non-SELV secondary circuit and an unearthed conductive part of the body.

INSULATION, DOUBLE: Insulation comprising both basic insulation and supplementary insulation.

INSULATION, REINFORCED: A single insulation system which provides a degree of protection against electric shock equivalent to double insulation under the conditions specified in the standard.

SAFE ELECTRICAL ISOLATION: Denotes an insulation system isolating a hazardous voltage circuit from a SELV circuit such that an insulation breakdown either is unlikely or does not cause a hazardous condition on the SELV circuit.

- Between an unearthed accessible conductive part or a floating SELV circuit, and a primary circuit.

4. CIRCUITS

PRIMARY CIRCUIT: An internal circuit which is directly connected to the external supply mains or other equivalent source (such as motor-alternator set) which supplies the electric power. It includes the primary windings of transformers, motors, other loading devices and the means of connection to the supply mains.

SECONDARY CIRCUIT: A circuit which has no direct connection to primary power and derives its power from a transformer, converter or equivalent isolation device situated within the equipment.

SAFETY EXTRA-LOW VOLTAGE (SELV) CIRCUIT: A circuit which is so designed and protected that under normal and single fault conditions the voltage between any two accessible parts, one of which may be the body or earth, does not exceed a safe value.

5. EQUIPMENTS

CLASS I EQUIPMENT: denotes equipment in which

protection against electric shock does not rely on basic insulation only, but which includes an additional safety precaution in that operator-accessible conductive parts are connected to the protective earthing conductor in the fixed wiring of the installation in such a way that the operator-accessible conductive parts cannot become hazardous in the event of a failure of the basic insulation.

Class I equipment may have parts with double insulation or reinforced insulation, or parts operating at safety extra-low voltage.

CLASS II EQUIPMENT denotes equipment in which protection against electric shock does not rely on basic insulation only, but in which additional safety precautions, such as double insulation or reinforced insulation, are provided, there being no provision for protective earthing or reliance upon installation conditions.

CLASS III EQUIPMENT: Equipment in which protection against electric shock relies upon supply from SELV circuits and in which hazardous voltages are not generated.

Table 4. Minimum Rating Requirements for a Working Voltage up to 250 Vrms

| Insulation | Creepage [mm] | Clearance [mm] | Isolation Barrier [mm] | Di. Strength [kV ac rms] | Isolation Resistance Ω |
|---------------|---------------|----------------|------------------------|--------------------------|-------------------------------|
| Operational | 2.5 | 3 | — | 0.5 | — |
| Basic | 3 | 4 | — | 1.5 | 2 10 ⁶ |
| Supplementary | 4 | 4 | — to 2 | 2.5 | 5 10 ⁶ |
| Reinforced | 8 | 8 | — to 2* | 2.5 to 3.75* | 7 10 ⁶ |

*See Table 3 for details.

Table 5. Electrical Interfaces and Required Insulation

| Case | Bare Metal Parts not Touchable | | Bare Metal Parts Touchable | |
|------|--------------------------------|-------------------------------------|--------------------------------------|--------------|
| | Primary Circuit (Line Voltage) | ELV Secondary Circuit ≤ 42.4 V | SELV Secondary Circuit ≤ 42.4 V | Earth Ground |
| 1. | | | | |
| 2. | | | | |
| 3. | | | | |
| 4. | | | | |
| 5. | | | | |
| 6. | | | | |
| 7. | | | | |
| | | | Class III Equipment | |
| | | | Class II Equipment | |
| | | | Class I Equipment | |

B = Basic Insulation F = Functional (Operational Insulation)
 R = Reinforced or Safe Insulation S = Supplementary Insulation

Guidelines for Circuit Board Assembly of Motorola Case 349 Opto Products

Prepared by: John Keller
Reliability Engineering

The increasing use of Motorola's Case 349 optoelectronics devices in individual pairs or in the custom slotted coupler/interrupter housings has given rise to questions regarding recommended methods of mounting, soldering and cleaning of this package.

To begin with, a brief description of the Case 349 construction as it relates to circuit board assembly is in order. Both the LED and detector devices have copper lead frames with a 150 micro inch minimum silver plating. The clear plastic molding compound is a non-filled epoxy with a minimum glass transition temperature of 110°C. The molded package features an integral lens on both the LED and detector devices. Also of major concern is the fact that the LED die is GaAs and is about ten times more brittle than Si. As a post mold operation the completed unit is solder dipped up to the stand-offs. All of these materials place constraints on each of the following circuit board assembly operations.

First, if lead forming/trimming operations are required, the guidelines to be followed are: (see Figure 1)

1. Lead forming by using the molded case as a fulcrum is not recommended. This places excessive pressures on the lead frame/package interface. It is recommended that the leads be clamped no closer to the package than the stand-offs before performing any lead forming.

2. Clamping of the leads for forming/trimming should be adequate enough to not allow accidental slipping thus causing a shearing action between the lead frame and molded package. This shearing force can lead to lateral sheared die especially on the GaAs LED devices. It is recommended that the lead trimming be accomplished after inserting and soldering. The second operation to be reviewed is component insertion.

1. An obvious but critical check prior to insertion is the lead hole clearance. If the hole clearance is not adequate, undue insertion force could result in a fractured lead-to-package seal and in the case of the LED device a sheared die. These insertion forces could become quite high when using automatic insertion machines.
2. The circuit board assembly should utilize a design which takes advantage of the stand-offs provided. The location of these stand-offs assures adequate remaining lead to package material to protect the package from the heat of the solder process.

The third and most critical assembly operation is the actual soldering step. The following matrix of suggested guidelines should be observed whether hand or wave soldering is used. Actual procedures and processes used are, of course, at the discretion of the component user.

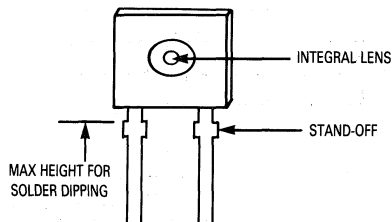

Figure 1.

AN979

| Solder Technique | Solder Type | Flux Type | Dwell Time | Comments |
|------------------|---|-----------|------------------|--|
| Wave Solder | 63/37 Tin Lead Bar | R* or RMA | < 10 Sec @ 230°C | Do not allow solder to go above the top of the tie bar; insertion/retraction rate to be less than 0.25 inches/sec. |
| Solder Pot | 63/37 Tin Lead Bar | R* or RMA | < 10 Sec @ 230°C | Do not allow solder to go above the top of the tie bar; insertion/retraction rate to be less than 0.25 inches/sec. |
| Soldering Iron | 60/40 Tin Lead Wire Rosin Core smallest possible diameter | | < 5 Sec | Must control soldering iron temperature for variations in operator speed |

*Per QQ-S-571

The most critical selection factor in the above materials is the type of solder flux. It is important to remember, depending on the length of heat exposure, all plastic molded devices expand when hot and can allow moisture to enter the package. With ambient heat this moisture can be baked out. The controlling factor is how free of ionic contaminants is the molding compound (Motorola's is less than 100 PPM) and soldering flux. Therefore, even though the units are dried or baked out, once any highly polar (active) contaminant is introduced into the package and onto the die surface any subsequent moisture (eg. humid environment) will eventually reach the surface of the die metal and corrosion can result. The less active the flux the better since the more active the flux the

greater chance there is of it penetrating the lead/package seal due to the package expanding at the high temperature of solder, and ultimately onto the die surface.

The fourth and final assembly operation is the PC board cleaning. Again, for the same reason as mentioned above, the use of harsh cleaners at high temperatures will result in contaminants entering the package with water-soluble fluxes. A recommended cleaning method is to use hot ($\approx 70^{\circ}\text{C}$) deionized water followed by a hot air dry or bake ($\approx 85^{\circ}\text{C}$) for one hour. The use of Freon or alcohol followed by a DI water rinse is also acceptable, especially with rosin-based fluxes. A good cleaning operation is critical in removing contaminants that can cause electrical leakage problems and also entrap moisture.

Applications of Zero Voltage Crossing Optically Isolated Triac Drivers

Prepared by Horst Gempe

INTRODUCTION

The zero-cross family of optically isolated triac drivers is an inexpensive, simple and effective solution for interface applications between low current dc control circuits such as logic gates and microprocessors and ac power loads (120, 240 or 380 volt, single or 3-phase).

These devices provide sufficient gate trigger current for high current, high voltage thyristors, while providing a guaranteed 7.5 kV dielectric withstand voltage between the line and the control circuitry. An integrated, zero-crossing switch on the detector chip eliminates current surges and the resulting electromagnetic interference (EMI) and reliability problems for many applications. The high transient immunity of 5000 V/ μ s, combined with the features of low coupling capacitance, high isolation resistance and up to 800 volt specified V_{DRM} ratings qualify this triac driver family as the ideal link between sensitive control circuitry and the ac power system environment.

Optically isolated triac drivers are not intended for stand alone service as are such devices as solid state relays. They will, however, replace costly and space demanding discrete drive circuitry having high component count consisting of standard transistor optoisolators, support components including a full wave rectifier bridge, discrete transistors, trigger SCRs and various resistor and capacitor combinations.

This paper describes the operation of a basic driving circuit and the determination of circuit values needed for proper implementation of the triac driver. Inductive loads are discussed along with the special networks required

to use triacs in their presence. Brief examples of typical applications are presented.

CONSTRUCTION

The zero-cross family consists of a liquid phase EPI, infrared, light emitting diode which optically triggers a silicon detector chip. A schematic representation of the triac driver is shown in Figure 1. Both chips are housed in a small, 6-pin dual-in-line (DIP) package which provides mechanical integrity and protection for the semiconductor chips from external impurities. The chips are insulated by an infrared transmissive medium which reliably isolates the LED input drive circuits from the environment of the ac power load. This insulation system meets the stringent requirements for isolation set forth by regulatory agencies such as UL and VDE.

THE DETECTOR CHIP

The detector chip is a complex monolithic IC which contains two infrared sensitive, inverse parallel, high voltage SCRs which function as a light sensitive triac. Gates of the individual SCRs are connected to high speed zero crossing detection circuits. This insures that with a continuous forward current through the LED, the detector will not switch to the conducting state until the applied ac voltage passes through a point near zero. Such a feature not only insures lower generated noise (EMI) and inrush (surge) currents into resistive loads and moderate inductive loads but it also provides high noise immunity (several thousand V/ μ s) for the detection circuit.

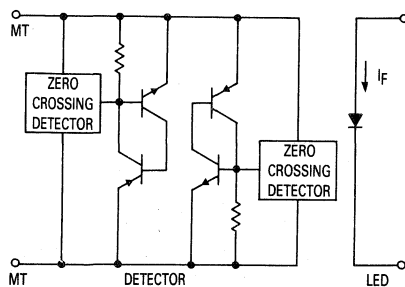

Figure 1. Schematic of Zero Crossing Optically Isolated Triac Driver

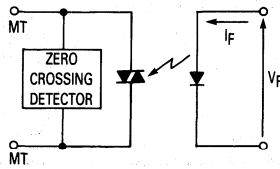

Figure 2. Simplified Schematic of Isolator

ELECTRICAL CHARACTERISTICS

A simplified schematic of the optically isolated triac driver is shown in Figure 2. This model is sufficient to describe all important characteristics. A forward current flow through the LED generates infrared radiation which triggers the detector. This LED trigger current (I_{FT}) is the maximum guaranteed current necessary to latch the triac driver and ranges from 5 mA for the MOC3063 to 15 mA for the MOC3061. The LED's forward voltage drop at $I_F = 30$ mA is 1.5 V maximum. Voltage-current characteristics of the triac are identified in Figure 3.

Once triggered, the detector stays latched in the "on state" until the current flow through the detector drops below the holding current (I_H) which is typically 100 μ A. At this time, the detector reverts to the "off" (non-conducting) state. The detector may be triggered "on" not only by I_{FT} but also by exceeding the forward blocking voltage between the two main terminals (MT1 and MT2) which is a minimum of 600 volts for all MOC3061 family members. Also, voltage ramps (transients, noise, etc.) which are common in ac power lines may trigger the detector accidentally if they exceed the static dV/dt rating. Since the fast switching, zero-crossing switch provides a minimum dV/dt of 500 V/ μ s even at an ambient temperature of 70°C, accidental triggering of the triac

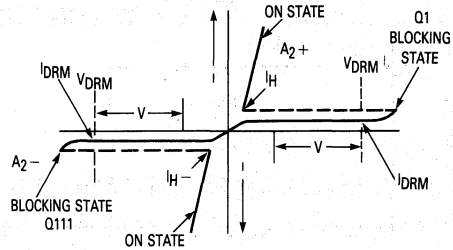

Figure 3. Triac Voltage-Current Characteristic

driver is unlikely. Accidental triggering of the main triac is a more likely occurrence. Where high dV/dt transients on the ac line are anticipated, a form of suppression network commonly called a "snubber" must be used to prevent false "turn on" of the main triac. A detailed discussion of a "snubber" network is given under the section "Inductive and Resistive Loads."

Figure 4 shows a static dV/dt test circuit which can be used to test triac drivers and power triacs. The proposed test method is per EIA/NARM standard RS-443.

Tests on the MOC3061 family of triac drivers using the test circuit of Figure 4 have resulted in data showing the effects of temperature and voltage transient amplitude on static dV/dt. Figure 5 is a plot of dV/dt versus ambient temperature while Figure 6 is a similar plot versus transient amplitude.

BASIC DRIVING CIRCUIT

Assuming the circuit shown in Figure 7 is in the blocking or "off" state (which means I_F is zero), the full ac line voltage appears across the main terminals of both the triac and the triac driver. When sufficient LED current (I_{FT}) is supplied and the ac line voltage is below the inhibit voltage (I_H in Figure 3), the triac driver latches "on." This action introduces a gate current in the main triac trig-

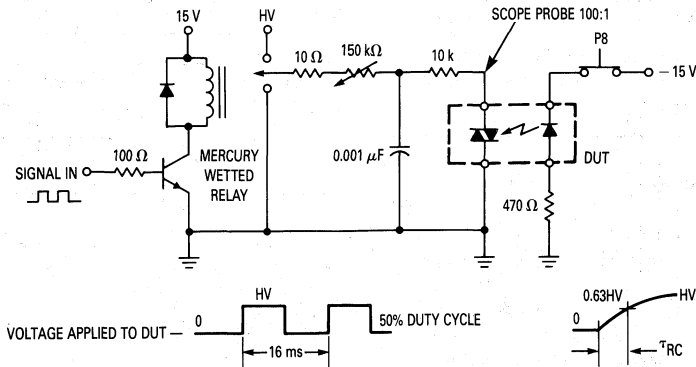

TEST PROCEDURE —

Turn the D.U.T. on, while applying sufficient dV/dt to ensure that it remains on, even after the trigger current is removed. Then decrease dV/dt until the D.U.T. turns off. Measure τ_{RC} , the time it takes to rise to 0.63 HV, and divide 0.63 HV by τ_{RC} to get dV/dt.

Figure 4. Static dV/dt Test Circuit

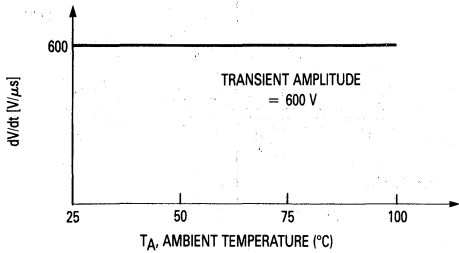

Figure 5. Static dV/dt versus Temperature

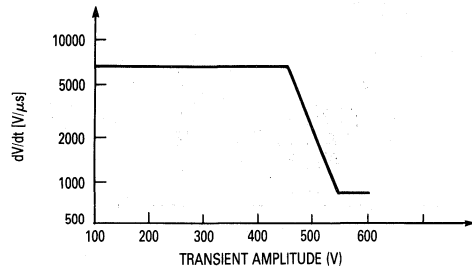

Figure 6. Static dV/dt versus Transient Amplitude

gering it from the blocking state into full conduction. Once triggered, the voltage across the main terminals collapses to a very low value which results in the triac driver output current decreasing to a value lower than its holding current, thus forcing the triac driver into the "off" state, even when I_{FT} is still applied.

The power triac remains in the conducting state until the load current drops below the power triac's holding current, a situation that occurs every half cycle. The actual duty cycle for the triac driver is very short (in the 1 to 3 μs region). When I_{FT} is present, the power triac will be retriggered every half cycle of the ac line voltage until I_{FT} is switched "off" and the power triac has gone through a zero current point. (See Figure 8).

Resistor R (shown in Figure 7) is not mandatory when R_L is a resistive load since the current is limited by the gate trigger current (I_{GT}) of the power triac. However, resistor R (in combination with R-C snubber networks that are described in the section "Inductive and Resistive Loads") prevents possible destruction of the triac driver in applications where the load is highly inductive.

Unintentional phase control of the main triac may happen if the current limiting resistor R is too high in value. The function of this resistor is to limit the current through the triac driver in case the main triac is forced into the non-conductive state close to the peak of the line voltage

and the energy stored in a "snubber" capacitor is discharged into the triac driver. A calculation for the current limiting resistor R is shown below for a typical 220 volt application: Assume the line voltage is 220 volts RMS. Also assume the maximum peak repetitive driver current (normally for a 10 micro second maximum time interval) is 1 ampere. Then

$$R = \frac{V_{peak}}{I_{peak}} = \frac{220 \sqrt{2} \text{ volts}}{1 \text{ amp}} = 311 \text{ ohms}$$

One should select a standard resistor value >311 ohms \rightarrow 330 ohms.

The gate resistor R_G (also shown in Figure 7) is only necessary when the internal gate impedance of the triac or SCR is very high which is the case with sensitive gate thyristors. These devices display very poor noise immunity and thermal stability without R_G . Value of the gate resistor in this case should be between 100 and 500. The circuit designer should be aware that use of a gate resistor increases the required trigger current (I_{GT}) since R_G drains off part of I_{GT} . Use of a gate resistor combined with the current limiting resistor R can result in an unintended delay or phase shift between the zero-cross point and the time the power triac triggers.

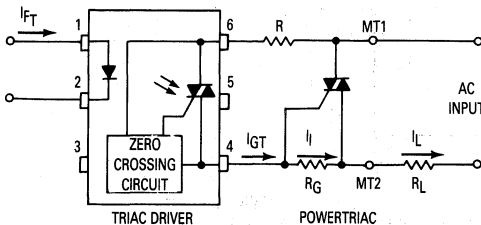

Figure 7. Basic Driving Circuit — Triac Driver, Triac and Load

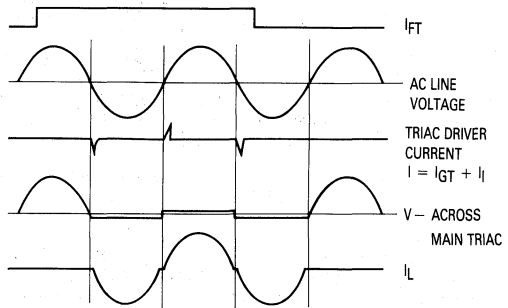

Figure 8. Waveforms of a Basic Driving Circuit

UNINTENDED TRIGGER DELAY TIME

To calculate the unintended time delay, one must remember that power triacs require a specified trigger current (I_{GT}) and trigger voltage (V_{GT}) to cause the triac to become conductive. This necessitates a minimum line voltage V_T to be present between terminals MT1 and MT2 (see Figure 7), even when the triac driver is already triggered "on." The value of minimum line voltage V_T is calculated by adding all the voltage drops in the trigger circuit:

$$V_T = V_R + V_{TM} + V_{GT}$$

Current I in the trigger circuit consists not only of I_{GT} but also the current through R_G :

$$I = I_{RG} + I_{GT}$$

Likewise, I_{RG} is calculated by dividing the required gate trigger voltage V_{GT} for the power triac by the chosen value of gate resistor R_G :

$$I_{RG} = V_{GT}/R_G$$

$$\text{Thus, } I = V_{GT}/R_G + I_{GT}$$

All voltage drops in the trigger circuit can now be determined as follows:

$$V_R = I \times R = V_{GT}/R_G \times R + I_{GT} \times R = R(V_{GT}/R_G + I_{GT})$$

$$V_{TM} = \text{From triac driver data sheet}$$

$$V_{GT} = \text{From power triac data sheet.}$$

$$I_{GT} = \text{From power triac data sheet.}$$

With V_{TM} , V_{GT} and I_{GT} taken from data sheets, it can be seen that V_T is only dependent on R and R_G .

Knowing the minimum voltage between MT1 and MT2 (line voltage) required to trigger the power triac, the unintended phase delay angle Θ_d (between the ideal zero crossing of the ac line voltage and the trigger point of the power triac) and the trigger delay time t_d can be determined as follows:

$$\begin{aligned} \Theta_d &= \sin^{-1} V_T/V_{\text{peak}} \\ &= \sin^{-1} \frac{R(V_{GT}/R_G + I_{GT}) + V_{TM} + V_{GT}}{V_{\text{peak}}} \end{aligned}$$

The time delay t_d is the ratio of Θ_d to $\Theta_{V_{\text{peak}}}$ (which is 90 degrees) multiplied by the time it takes the line voltage to go from zero voltage to peak voltage (simply $1/4f$, where f is the line frequency). Thus

$$t_d = \Theta_d/90 \times 1/4f$$

Figure 9 shows the trigger delay of the main triac versus the value of the current limiting resistor R for assumed values of I_{GT} . Other assumptions made in plotting the equation for t_d are that line voltage is 220 V RMS which leads to $V_{\text{peak}} = 311$ volts; $R_G = 300$ ohms; $V_{GT} = 2$ volts and $f = 60$ Hz. Even though the triac driver triggers close to the zero cross point of the ac voltage, the power triac cannot be triggered until the voltage of the ac line rises high enough to create enough current flow to latch the power triac in the "on" state. It is apparent that significant time delays from the zero crossing point can be observed when R is a large value along with a high value of I_{GT} and/or a low value of R_G . It should

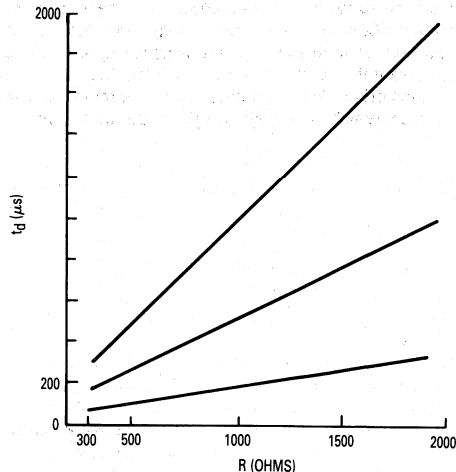

Figure 9. Time Delay t_d versus Current Limiting Resistor R

be remembered that low values of the gate resistor improve the dV/dt ratings of the power triac and minimize self latching problems that might otherwise occur at high junction temperatures.

SWITCHING SPEED

The switching speed of the triac driver is a composition of the LED's turn on time and the detector's delay, rise and fall times. The harder the LED is driven the shorter becomes the LED's rise time and the detector's delay time. Very short I_{FT} duty cycles require higher LED currents to guarantee "turn on" of the triac driver consistent with the speed required by the short trigger pulses.

Figure 10 shows the dependency of the required LED current normalized to the dc trigger current required to trigger the triac driver versus the pulse width of the LED current. LED trigger pulses which are less than $100 \mu\text{s}$ in width need to be higher in amplitude than specified on the data sheet in order to assure reliable triggering of the triac driver detector.

The switching speed test circuit is shown in Figure 11. Note that the pulse generator must be synchronized with the 60 Hz line voltage and the LED trigger pulse must occur near the zero cross point of the ac line voltage. Peak ac current in the curve tracer should be limited to 10 mA. This can be done by setting the internal load resistor to 3 k ohms.

Motorola isolated triac drivers are trigger devices and designed to work in conjunction with triacs or reverse parallel SCRs which are able to take rated load current. However, as soon as the power triac is triggered there is no current flow through the triac driver. The time to turn the triac driver "off" depends on the switching speed of the triac, which is typically on the order of 1–2 μs .

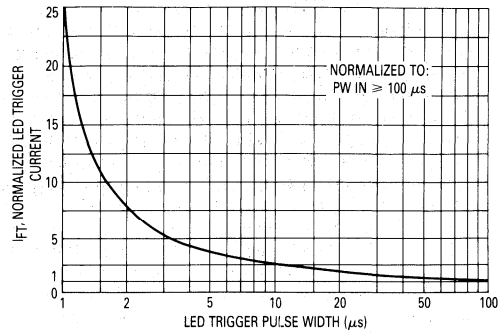

Figure 10. I_{FT} Normalized to I_{FT} dc As Specified on the Data Sheet

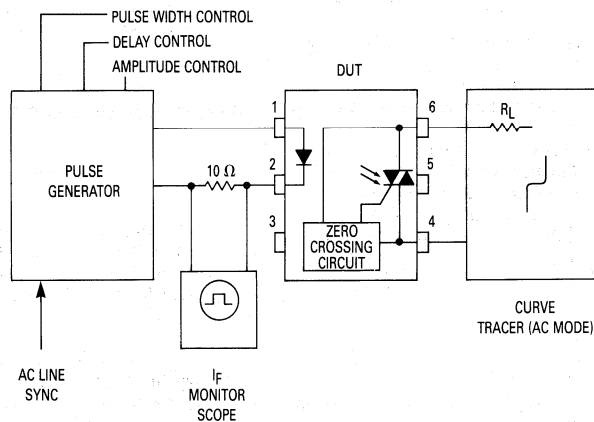

Figure 11. Test Circuit for LED Forward Trigger Current versus Pulse Width

INDUCTIVE AND RESISTIVE LOADS

Inductive loads (motors, solenoids, etc.) present a problem for the power triac because the current is not in phase with the voltage. An important fact to remember is that since a triac can conduct current in both directions, it has only a brief interval during which the sine wave current is passing through zero to recover and revert to its blocking state. For inductive loads, the phase shift between voltage and current means that at the time the current of the power handling triac falls below the holding current and the triac ceases to conduct, there exists a certain voltage which must appear across the triac. If this voltage appears too rapidly, the triac will resume conduction and control is lost. In order to achieve control with certain inductive loads, the rate of rise in voltage (dV/dt) must be limited by a series RC network placed in parallel with the power triac. The capacitor C_S will limit the dV/dt across the triac.

The resistor R_S is necessary to limit the surge current from C_S when the triac conducts and to damp the ringing of the capacitance with the load inductance L_L . Such an RC network is commonly referred to as a "snubber."

Figure 12 shows current and voltage wave forms for the power triac. Commutating dV/dt for a resistive load is typically only $0.13 \text{ V}/\mu\text{s}$ for a 240 V, 50 Hz line source and $0.063 \text{ V}/\mu\text{s}$ for a 120 V, 60 Hz line source. For inductive loads the "turn off" time and commutating dV/dt stress are more difficult to define and are affected by a number of variables such as back EMF of motors and the ratio of inductance to resistance (power factor). Although it may appear from the inductive load that the rate or rise is extremely fast, closer circuit evaluation reveals that the commutating dV/dt generated is restricted to some finite value which is a function of the load reactance L_L and the device capacitance C but still may exceed the triac's critical commutating dV/dt rating which is about $50 \text{ V}/\mu\text{s}$.

It is generally good practice to use an RC snubber network across the triac to limit the rate of rise (dV/dt) to a value below the maximum allowable rating. This snubber network not only limits the voltage rise during commutation but also suppresses transient voltages that may occur as a result of ac line disturbances.

There are no easy methods for selecting the values for R_S and C_S of a snubber network. The circuit of Figure 13 is a damped, tuned circuit comprised of R_S , C_S , R_L and L_L , and to a minor extent the junction capacitance of the triac. When the triac ceases to conduct (this occurs every half cycle of the line voltage when the current falls below the holding current), the load current receives a step impulse of line voltage which depends on the power factor of the load. A given load fixes R_L and L_L ; however, the circuit designer can vary R_S and C_S . Commutating dV/dt can be lowered by increasing C_S while R_S can be increased to decrease resonant "over ringing" of the tuned circuit. Generally this is done experimentally

beginning with values calculated as shown in the next section and, then, adjusting R_S and C_S values to achieve critical damping and a low critical rate of rise of voltage.

Less sensitive to commutating dV/dt are two SCRs in an inverse parallel mode often referred to as a back-to-back SCR pair (see Figure 15). This circuit uses the SCRs in an alternating mode which allows each device to recover and turn "off" during a full half cycle. Once in the "off" state, each SCR can resist dV/dt to the critical value of about $100 V/\mu s$. Optically isolated triac drivers are ideal in this application since both gates can be triggered by one triac driver which also provides isolation between the low voltage control circuit and the ac power line.

It should be mentioned that the triac driver detector does not see the commutating dV/dt generated by the inductive load during its commutation; therefore, the commutating dV/dt appears as a static dV/dt across the two main terminals of the triac driver.

Figure 12. Current and Voltage Waveforms During Commutation

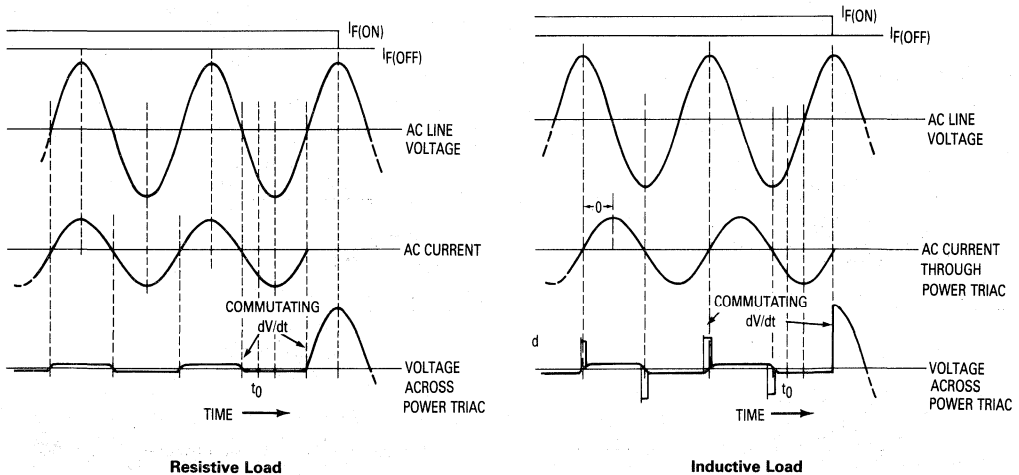

SNUBBER DESIGN — THE RESONANT METHOD

If R, L and C are chosen to resonate, the voltage waveform on dV/dt will look like Figure 14. This is the result of a damped quarter-cycle of oscillation. In order to calculate the components for snubbing, the dV/dt must be related to frequency. Since, for a sine wave,

$$V(t) = V_p \sin \omega t$$

$$dV/dt = V_p \omega \cos \omega t$$

$$dV/dt(\max) = V_p \omega = V_p 2\pi f$$

$$f = \frac{dV/dt}{2\pi V_A(\max)}$$

Where dV/dt is the maximum value of off state dV/dt specified by the manufacturer.

From:

$$f = \frac{1}{2\pi\sqrt{LC}}$$

$$C = \frac{1}{(2\pi f)^2 L}$$

We can choose the inductor for convenience. Assuming the resistor is chosen for the usual 30% overshoot:

$$R = \sqrt{\frac{L}{C}}$$

Assuming L is 50 μH, then:

$$f = \frac{(dV/dt)_{\min}}{2\pi V_A(\max)} = \frac{50 \text{ V}/\mu\text{s}}{2\pi(294 \text{ V})} = 27 \text{ kHz}$$

$$C = \frac{1}{(2\pi f)^2 L} = 0.69 \mu\text{F}$$

$$R = \sqrt{\frac{L}{C}} = \sqrt{\frac{50 \mu\text{H}}{0.69 \mu\text{F}}} = 8.5 \Omega$$

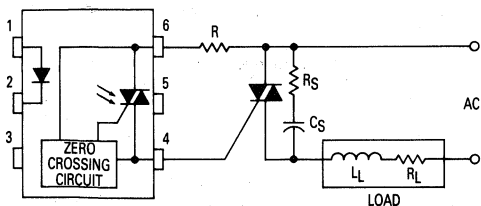

Figure 13. Triac Driving Circuit — with Snubber

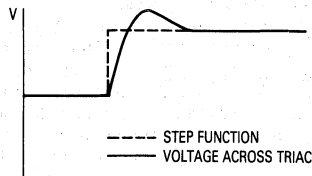

Figure 14. Voltage Waveform After Step Voltage Rise — Resonant Snubbing

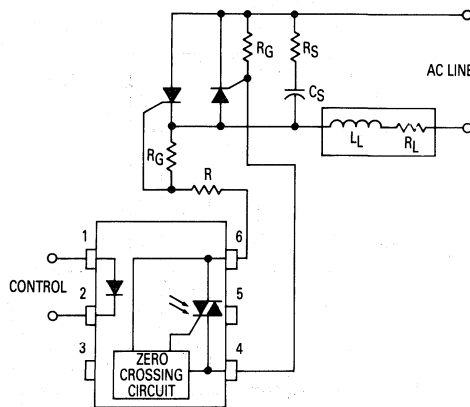

Figure 15. A Circuit Using Inverse Parallel SCRs

INRUSH (SURGE) CURRENTS

The zero crossing feature of the triac driver insures lower generated noise and sudden inrush currents on resistive loads and moderate inductive loads. However, the user should be aware that many loads even when started at close to the ac zero crossing point present a very low impedance. For example, incandescent lamp filaments when energized at the zero crossing may draw ten to twenty times the steady state current that is drawn when the filament is hot. A motor when started pulls a "locked rotor" current of, perhaps, six times its running current. This means the power triac switching these loads must be capable of handling current surges without junction overheating and subsequent degradation of its electrical parameters.

Almost pure inductive loads with saturable ferromagnetic cores may display excessive inrush currents of 30 to 40 times the operating current for several cycles when

switched "on" at the zero crossing point. For these loads, a random phase triac driver (MOC3020 family) with special circuitry to provide initial "turn on" of the power triac at ac peak voltage may be the optimized solution.

ZERO CROSS, THREE PHASE CONTROL

The growing demand for solid state switching of ac power heating controls and other industrial applications has resulted in the increased use of triac circuits in the control of three phase power. Isolation of the dc logic circuitry from the ac line, the triac and the load is often desirable even in single phase power control applications. In control circuits for poly phase power systems, this type of isolation is mandatory because the common point of the dc logic circuitry cannot be referred to a common line in all phases. The MOC3061 family's characteristics of high off-state blocking voltage and high iso-

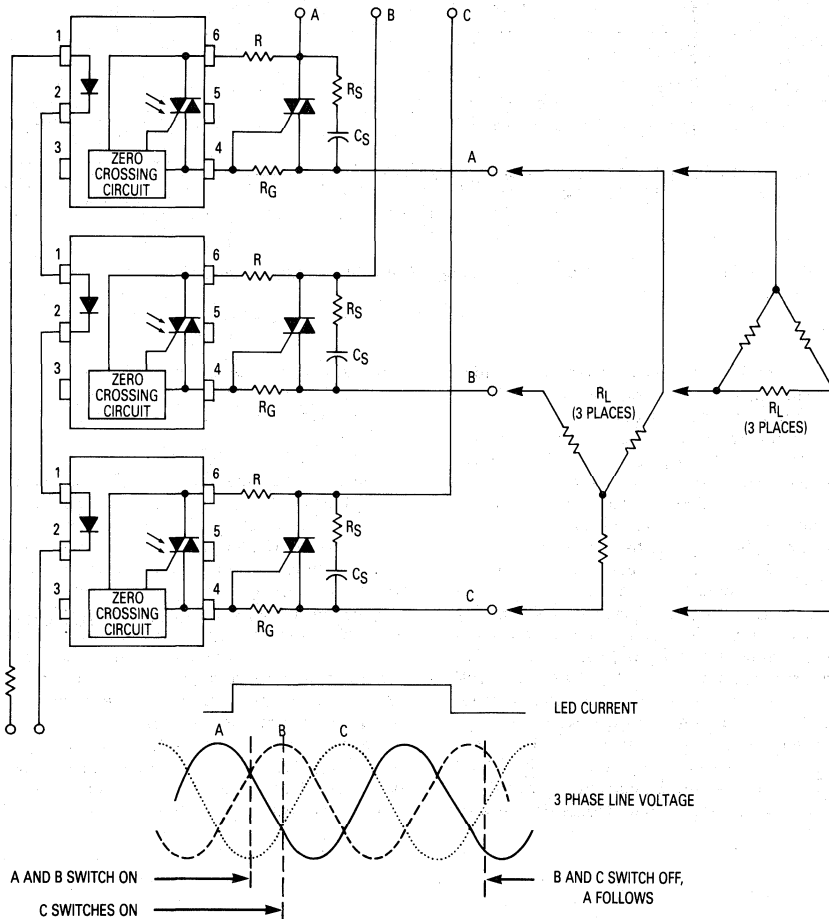

Figure 16. 3 Phase Control Circuit

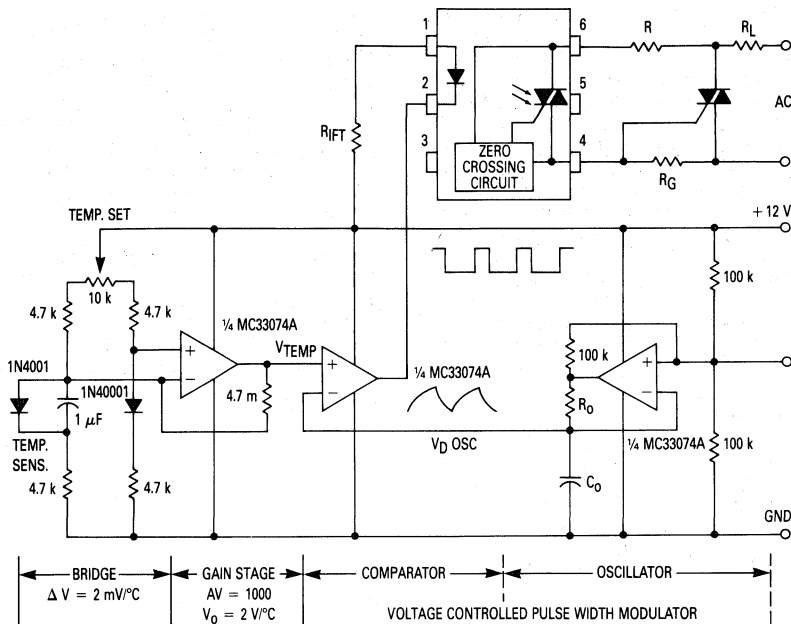

Figure 17. Proportional Zero Voltage Switching Temperature Controller

lation capability make the isolated triac drivers ideal devices for a simplified, effective control circuit with low component count as shown in Figure 16. Each phase is controlled individually by a power triac with optional snubber network (R_S , C_S) and an isolated triac driver with current limiting resistor R . All LEDs are connected in series and can be controlled by one logic gate or controller. An example is shown in Figure 17.

At startup, by applying I_F , the two triac drivers which see zero voltage differential between phase A and B or A and C or C and B (which occurs every 60 electrical degrees of the ac line voltage) will switch "on" first. The third driver (still in the "off" state) switches "on" when the voltage difference between the phase to which it is connected approaches the same voltage as the sum voltage (superimposed voltage) of the phases already switched "on." This guarantees zero current "turn on" of all three branches of the load which can be in Y or Delta configuration. When the LEDs are switched "off," all phases switch "off" when the current (voltage difference) between any two of the three phases drops below

the holding current of the power triacs. Two phases switched "off" create zero current. In the remaining phase, the third triac switches "off" at the same time.

PROPORTIONAL ZERO VOLTAGE SWITCHING

The built-in zero voltage switching feature of the zero-cross triac drivers can be extended to applications in which it is desirable to have constant control of the load and a minimization of system hysteresis as required in industrial heater applications, oven controls, etc. A closed loop heater control in which the temperature of the heater element or the chamber is sensed and maintained at a particular value is a good example of such applications. Proportional zero voltage switching provides accurate temperature control, minimizes overshoots and reduces the generation of line noise transients.

Figure 17 shows a low cost MC33074 quad op amp which provides the task of temperature sensing, amplification, voltage controlled pulse width modulation and triac driver LED control. One of the two 1N4001 diodes

AN982

(which are in a Wheatstone bridge configuration) senses the temperature in the oven chamber with an output signal of about $2 \text{ mV}/^\circ\text{C}$. This signal is amplified in an inverting gain stage by a factor of 1000 and compared to a triangle wave generated by an oscillator. The comparator and triangle oscillator form a voltage controlled pulse width modulator which controls the triac driver. When the temperature in the chamber is below the desired value, the comparator output is low, the triac driver and the triac are in the conducting state and full power is applied to the load. When the oven temperature comes close to the desired value (determined by the "temp set" potentiometer), a duty cycle of less than 100% is introduced providing the heater with proportionally less power until equilibrium is reached. The proportional band can be controlled by the amplification of the gain stage — more gain provides a narrow band; less gain a wider band. Typical waveforms are shown in Figure 18.

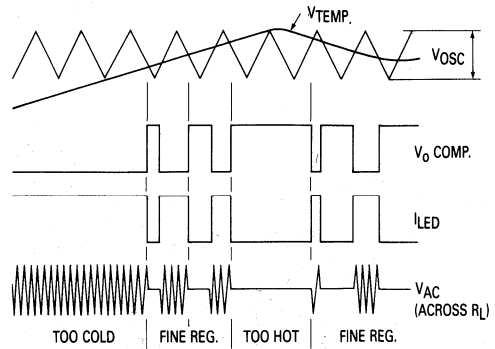

Figure 18. Typical Waveforms of Temperature Controller

NOTES

1 **General Information**

2 **Quality and Reliability**

3 **Selector Guide and Cross-Reference**

4 **Discrete Emitters/Detectors
Data Sheets**

5 **Fiber Optics Components
Data Sheets**

6 **Optoisolators/Optocouplers
Data Sheets**

7 **Slotted Optical Switches
Data Sheets**

8 **Chips
Data Sheets**

9 **Applications Information**



Literature Distribution Centers:

USA: Motorola Literature Distribution; P.O. Box 20912; Phoenix, Arizona 85036.

EUROPE: Motorola Ltd.; European Literature Center; 88 Tanners Drive, Blakelands, Milton Keynes, MK14 5BP, England.

ASIA PACIFIC: Motorola Semiconductors H.K. Ltd.; P.O. Box 80300; Cheung Sha Wan Post Office; Kowloon Hong Kong.

JAPAN: Nippon Motorola Ltd.; 3-20-1 Minamiazabu, Minato-ku, Tokyo 106 Japan.